

BUILD YOUR OWN VIDEO TELEPHONE!

48783

Radio Electronics®

MARCH 1991

TECHNOLOGY - VIDEO - STEREO - COMPUTERS - SERVICE

BUILD R-E's VIDEO TELEPHONE

Add a new dimension to your phone conversations with our easy-to-build high-resolution circuit!

TURN YOUR PC INTO A FREQUENCY COUNTER

Universal counter board runs under windows

BUILD R-E'S AUDIO SWEEP/MARKER GENERATOR

A must for testing audio amplifier and filter circuit performance

SEMICONDUCTOR MEMORIES

An examination of today's technology and a peek at tomorrow's

FERROELECTRIC DEVICES

New advances deliver better non-volatile memories

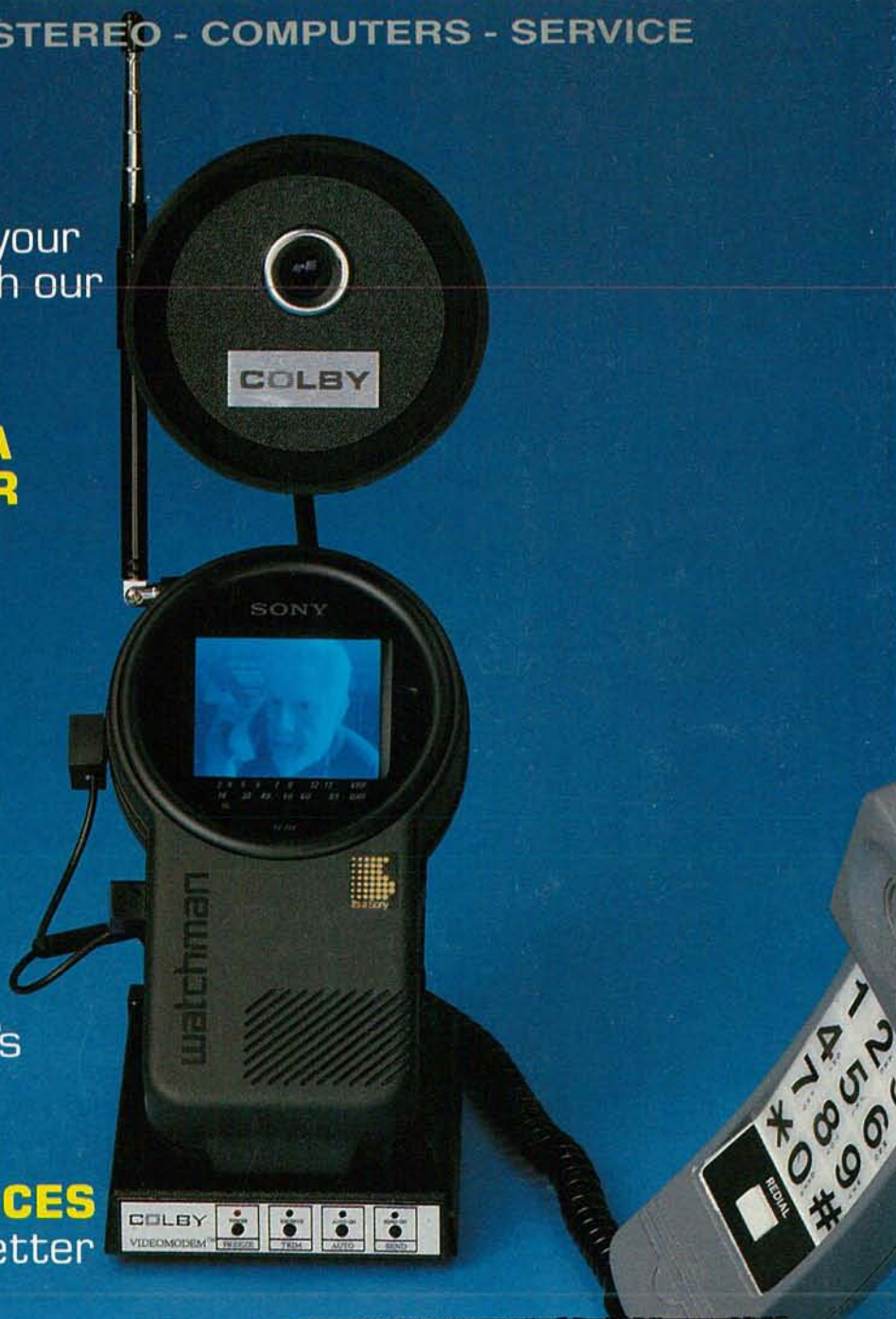

\$2.95 U.S.
\$3.75 CAN

A
GERNSBACK
PUBLICATION

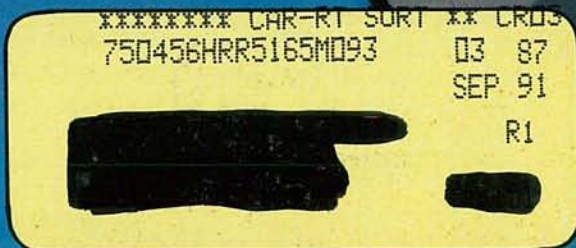

FLUKE



PHILIPS



Great Choice.

More professionals in more industries make Fluke their first choice in multimeters.

Fluke DMMs. Reliable. Accurate. Powerful. Tough. Versatile. Easy to use and simple to operate. Backed by the longest, most comprehensive warranty in the business. Made in the U.S.A. In short, Fluke makes meters you can bet your reputation on.

More choice. No matter what the job, there's a Fluke to handle it.

There's the new 80 Series—the most powerful, most complete test and measurement system available in a handheld package.

The popular 70 Series—simply put, the most requested DMM in the world, with nearly 2 million units in service since 1984. And the Fluke 21 and 23—70 Series simplicity in high-visibility yellow.

The Fluke 25 and 27—the most rugged meters ever built, totally sealed against water, dust and other contaminants.

And the precise 8060 Series—with the versatility of a test lab, the accuracy of a bench instrument, and the convenience of a handheld.

Smart choice. Compare Fluke DMMs with any other handheld. No one else gives you as much meter for your money. And no other meter costs less to own.

Your choice. For the name of your nearest Fluke distributor, call toll-free **1-800-44-FLUKE, ext. 33.** And make a great choice.

John Fluke Mfg. Co., Inc. P.O. Box C9090 MIS 250C Everett, WA 98206. U.S.: (206) 356-5400. Canada: (416) 890-7600. Other Countries: (206) 356-5500. © 1989 John Fluke Mfg. Co., Inc. All rights reserved. Ad No. 0491-F70

FROM THE WORLD LEADER
IN DIGITAL MULTIMETERS

FLUKE

CIRCLE 121 ON FREE INFORMATION CARD

BUILD THIS

- 33 BUILD THIS VIDEO PHONE**
Send and receive video pictures over standard phone lines!
Charles Colby
- 43 TURN YOUR PC INTO A UNIVERSAL FREQUENCY COUNTER**
Build a frequency-counter/timer board that works with windows.
Joe Grasty and Bill Schulz
- 55 AUDIO SWEEP/MARKER GENERATOR**
Display the frequency response of your amplifier or filter design.
John Wannamaker

TECHNOLOGY

- 63 FERROELECTRIC IC'S: CHIPS THAT REMEMBER**
Will they make lost data a thing of the past?
TJ Byers
- 68 SEMICONDUCTOR MEMORIES**
A look at memory technology, now and in the future.
Stephen J. Bigelow

DEPARTMENTS

- | | |
|---|--|
| <ul style="list-style-type: none">6 VIDEO NEWS
What's new in this fast-changing field.
David Lachenbruch22 EQUIPMENT REPORTS
Fluke Model 45 Dual-Display Digital Multimeter74 AUDIO UPDATE
Transfer functions revisited.
Larry Klein | <ul style="list-style-type: none">77 DRAWING BOARD
Build a 5-volt, 5-amp power supply for your test bench.
Robert Grossblatt84 COMPUTER CONNECTIONS
Making connections.
Jeff Holtzman |
|---|--|



PAGE 63



PAGE 55

AND MORE

- 98 Advertising and Sales Offices**
- 98 Advertising Index**
- 12 Ask R-E**
- 16 Letters**
- 87 Market Center**
- 24 New Products**
- 4 What's News**
- 52A R-E Shopper***

*Included in selected issues only.

ON THE COVER



It's been more than half a century since the picture phone made its debut at the 1939 World's Fair. It was a big idea, with a price tag and equipment sized to match. Now there's an IC that greatly reduces the cost and size of a video-phone system. Our version of the video phone, or video modem, transmits and receives high-resolution, still-video frames. It consists of a base unit that we show connected to a small CCD camera module and to a Sony Watchman; a standard video camera or camcorder and a monitor will work just as well. You can send or receive images anywhere in the world, as long as the person at the other end has a video phone too. Turn to page 33 to find out how to make a couple of video phones—or get a friend to build the second!

COMING NEXT MONTH

THE APRIL ISSUE GOES ON SALE MARCH 1.

BUILD AN ELF MONITOR

Measure your exposure to potentially hazardous extremely-low-frequency (60-Hz) magnetic fields.

FCC APPROVES NO-CODE HAM LICENSE

Docket 90-55 approved for Technician-Class no-code license.

EXPERIMENTS IN VOICE RECOGNITION

Put the VCP200 IC to use in an assortment of projects.

BUILD A ROBOT

Learn about microcontrollers, obstacle avoidance, and stepper-motor control by building this 8748-based robot.

BUILD A 40-WATT POWER INVERTER

It converts 12 volts DC to 120 volts AC.

As a service to readers, RADIO-ELECTRONICS publishes available plans or information relating to newsworthy products, techniques and scientific and technological developments. Because of possible variances in the quality and condition of materials and workmanship used by readers, RADIO-ELECTRONICS disclaims any responsibility for the safe and proper functioning of reader-built projects based upon or from plans or information published in this magazine.

Since some of the equipment and circuitry described in RADIO-ELECTRONICS may relate to or be covered by U.S. patents, RADIO-ELECTRONICS disclaims any liability for the infringement of such patents by the making, using, or selling of any such equipment or circuitry, and suggests that anyone interested in such projects consult a patent attorney.

RADIO-ELECTRONICS, (ISSN 0033-7862) March 1991. Published monthly by Gernsback Publications, Inc., 500-B Bi-County Boulevard, Farmingdale, NY 11735 Second-Class Postage paid at Farmingdale, NY and additional mailing offices. Second-Class mail registration No. 9242 authorized at Toronto, Canada. One-year subscription rate U.S.A. and possessions \$17.97, Canada \$23.97, all other countries \$26.97. All subscription orders payable in U.S.A. funds only, via international postal money order or check drawn on a U.S.A. bank. Single copies \$2.95. © 1991 by Gernsback Publications, Inc. All rights reserved. Printed in U.S.A.

POSTMASTER: Please send address changes to RADIO-ELECTRONICS, Subscription Dept., Box 55115, Boulder, CO 80321-5115.

A stamped self-addressed envelope must accompany all submitted manuscripts and/or artwork or photographs if their return is desired should they be rejected. We disclaim any responsibility for the loss or damage of manuscripts and/or artwork or photographs while in our possession or otherwise.

Radio Electronics®

Hugo Gernsback (1884-1967) founder

Larry Steckler, EHF, CET,
editor-in-chief and publisher

EDITORIAL DEPARTMENT

Brian C. Fenton, editor
Marc Spiwak, associate editor
Kim Dunleavy,
assistant technical editor
Teri Scaduto, assistant editor
Jeffrey K. Holtzman
computer editor
Robert Grossblatt, circuits editor
Larry Klein, audio editor
David Lachenbruch
contributing editor
Don Lancaster
contributing editor
Richard D. Fitch
contributing editor
Kathy Terenzi, editorial assistant

ART DEPARTMENT

Andre Duzant, art director
Injae Lee, illustrator
Russell C. Truelson, illustrator

PRODUCTION DEPARTMENT

Ruby M. Yee, production director
Janice Box,
editorial production
Karen S. Tucker
advertising production
Marcella Amoroso
production assistant

CIRCULATION DEPARTMENT

Jacqueline P. Cheeseboro
circulation director
Wendy Alanko
circulation analyst
Theresa Lombardo
circulation assistant
Michele Torrillo, reprint bookstore

Typography by Mates Graphics
Cover photo by Diversified Photo
Services

Radio-Electronics is indexed in
Applied Science & Technology Index
and *Readers Guide to Periodical Literature*.

Microfilm & microfiche editions are available. Contact circulation department for details.

Advertising Sales Offices listed on page 98.

Radio-Electronics Executive and
Administrative Offices
1-516-293-3000
Subscriber Customer Service:
1-800-288-0652
Order Entry for New Subscribers:
1-800-999-7139

The
Audit
Bureau
of Circulation



RADIO SHACK PARTS PLACESM



Talking Multimeter. Press a button on the probe and this meter calls out the reading while displaying it on a high-contrast LC display. Full auto-ranging, continuity sounder, diode-check mode. Low-battery and over-range indicators. #22-164 99.95



"HOTLINE" SPECIAL-ORDER SERVICE

Your nearby Radio Shack stocks over 1000 popular electronic parts and can special-order many items from our main warehouse—ICs, tubes, semiconductors, phono cartridges and styli, even SAMS[®] manuals. We can also supply replacement batteries for cordless phones, computer memory, transceivers, pagers and more. Service is fast and there is no postage charge.



(1) **Universal Breadboard.** Our best! Molded 2 1/4 x 6 1/2" board on 7 x 4" steel base with rubber feet and three binding posts. #276-169 19.95
(2) **Breadboard Jumper Wire Kit.** Our 140-piece set of ready-to-use hookup wires. #276-173 4.95

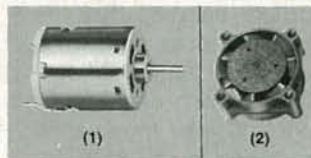

(1) **High-Speed 12VDC Motor.** Up to 15,200 RPM at no load. About 2" long (with shaft). #273-255 ... 2.99
(2) **12VDC Brushless Micro Fan.** For cooling mobile equipment and hum-sensitive circuits. Rated 4.6 CFM. 150 mA. #273-244 ... 17.95

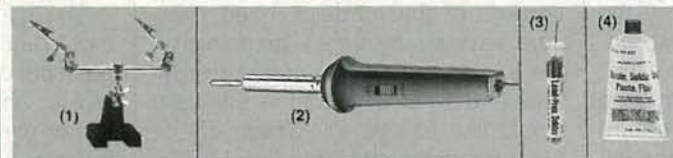

(1) **Adjustable Project Holder.** Our extra-sturdy "Helping Hands" holder simplifies soldering, gluing and assembly work. #64-2093 8.19
(2) **Dual-Wattage Soldering Iron.** Go from 15 to 30 watts with the flick of a switch. 8 1/4" long. UL listed AC. #64-2055 9.49
(3) **Lead-Free Solder.** Top choice for fine electronics work. 96% tin, 4% silver composition. .032"-diameter. 0.25 oz. #64-025 1.99
(4) **Soldering Paste Flux.** #64-021 1.79

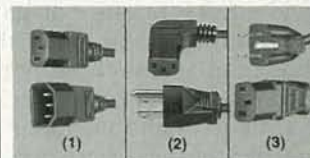

Computer/Business Machine AC Power Cords. 6 ft. HP (CEE-type) connectors. UL listed.
(1) **Extension.** #278-1259 ... 4.99
(2) **90° Type.** #278-1260 ... 5.99
(3) **With Straight CEE Connector.** #278-1257 3.99

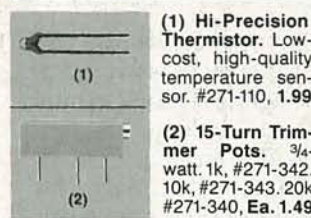

(1) **Hi-Precision Thermistor.** Low-cost, high-quality temperature sensor. #271-110, 1.99
(2) **15-Turn Trimmer Pots.** 3/4-watt. 1k, #271-342, 10k, #271-343, 20k, #271-340, Ea. 1.49



Infrared Module. Ready-to-use module for remote-control projects. Combines an IR detector, limiter and demodulator in a compact 3-lead package. 5VDC. With data. #276-137 ... 3.49

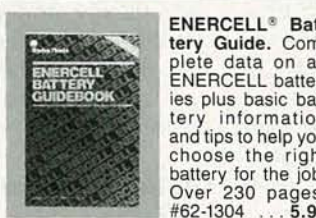

ENERCELL[®] Battery Guide. Complete data on all ENERCELL batteries plus basic battery information and tips to help you choose the right battery for the job. Over 230 pages. #62-1304 ... 5.95



Mini Audio Amplifier. Perfect for use as a test-bench amp and for computer voice/music synthesis. Built-in speaker plus 1/8" headphone jack, 1/8" input jack, volume control. #277-1008, 11.95



(1) **Stackable Banana Plugs.** Jack for "chain" hook-up. One red and one black. #274-734, Set 1.59
(2) **Package of 10 Jumper Leads.** 14" long. Mini 'gator clips. #278-1156 ... 3.99



Miniature Piezo Speaker. Only 1 3/32"-diameter by 5/64" thin. Efficient 1200-ohm audio transducer can be directly driven by ICs. Response: 500 Hz to 20 kHz. 273-091 2.49



Modular Balun. BNC male connector to standard modular phone jack. Lets you use phone cable in place of more costly shielded cable in computer network hookups. #276-1410 .. 16.95

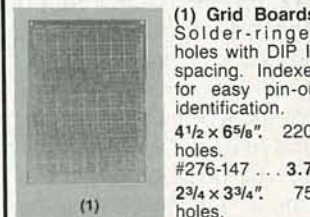

(1) **Grid Boards.** Solder-ringed holes with DIP IC spacing. Indexed for easy pin-out identification.
4 1/2 x 6 5/8". 2200 holes. #276-147 ... 3.79
2 3/4 x 3 3/4". 750 holes. #276-158 ... 2.29

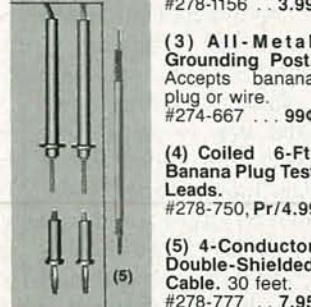

(3) **All-Metal Grounding Post.** Accepts banana plug or wire. #274-667 ... 99c
(4) **Coiled 6-Ft. Banana Plug Test Leads.** #278-750, Pr/4.99
(5) **4-Conductor Double-Shielded Cable.** 30 feet. #278-777 ... 7.95

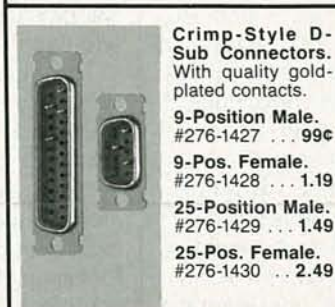

Crimp-Style D-Sub Connectors. With quality gold-plated contacts.
9-Position Male. #276-1427 ... 99c
9-Pos. Female. #276-1428 ... 1.19
25-Position Male. #276-1429 ... 1.49
25-Pos. Female. #276-1430 ... 2.49



D-Sub Pin Crimping Tool. This professional steel tool makes it easy to install D-sub connectors. Accepts #20, #24 and #28 pins. Comfortable cushioned handles provide a firm, secure grip. 6 7/8" long. #276-1595 ... 9.95

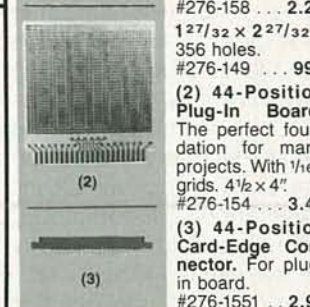

(2) **44-Position Plug-In Board.** The perfect foundation for many projects. With 1/16" grids. 4 1/2 x 4". #276-154 ... 3.49
(3) **44-Position Card-Edge Connector.** For plug-in board. #276-1551 ... 2.99

Since 1921 Radio Shack has been the place to obtain up-to-date electronic parts as well as quality tools, test equipment and accessories at low prices. Over 7000 locations to serve you—NOBODY COMPARES

Prices apply at participating Radio Shack stores and dealers. Radio Shack is a division of Tandy Corporation

Radio Shack[®]
AMERICA'S TECHNOLOGY STORESM

MARCH 1991

WHAT'S NEWS

A review of the latest happenings in electronics.

How they captured the Olympics.

In mid-September 1990, the city of Atlanta, GA celebrated the International Olympic Committee's (IOC) announcement that it had been chosen as the site for the 1996 Summer Olympics. Perhaps one of the factors influencing that decision was the high-tech, multi-media presentation of Atlanta's proposal. Developed by researchers at the Georgia Institute of Technology with the assistance of Georgia State University and several private companies, the innovative system used three videodisc players, three computers, computer-composed music, digitized narration, and a unique interaction system that includes a computer-animated, touch-sensitive model of the proposed Olympic Village. The presentation was controlled by a Commodore Amiga computer; an Apple Macintosh IIcx and a smaller computer-interface device were also used.

Computer graphics, which provided both detailed interior scenes and a bird's-eye view of the entire Olympic Village from an altitude of about 500 feet, were merged with real images shot on film; a computer-generated "Golden Athlete" carried the Olympic torch to open the program. Faced with a tight budget and limited production time, the researchers managed to get high-quality images without using multiple cameras by using an anamorphic lens and telecine techniques. Three side-by-side video-projection screens provide a 120-degree wrap-around view. The musical accompaniment was composed and generated on the Amiga computer, which was used to coordinate all the various activities.

The presentation package used a touch-sensitive, three-dimensional map of the proposed Olympic village. Animation included clouds, moving vehicles, and a fireworks display, along with the icons used to choose portions of the presentation for viewing. Because of the raised buildings molded into the maps, conventional



FIG. 1—GEORGIA TECH'S MULTI-MEDIA PRESENTATION to the International Olympic Committee included a three-screen computer-generated view of the proposed Olympic Village.

touch-sensitive conductive areas or infrared beams couldn't be used. Instead, load cells located on the four corners of the model sensed pressure exerted by users pressing on the icons, and a small computer determined what information the user would like to see. A sample of the presentation is shown in Fig. 1.

Georgia Tech hopes to use the Olympic project as a stepping stone to the formation of a new, industrially sponsored, multimedia technology research center. Research projects will include telecommunications technology and policy, computer graphics and scientific visualization, translations for the hearing impaired, and a workstation teleconference prototype.

Digital simulcast HDTV system.

The Advanced Television Research Consortium (ATRC)—which includes NBC, the David Sarnoff Research Center, Philips Consumer Electronics Company, and Thomson Consumer Electronics, Inc.—is focusing on a digital simulcast system that it believes offers a practical digital solution for HDTV. The proposed Advanced Digital Television system, to be jointly developed by the David Sarnoff Research Center and Philips, would preserve existing NTSC channel allocations and ensure the availability of high-quality television images in the United States through the established terrestrial transmission system. According to the ATRC, the digital approach will also increase America's global competitiveness by establishing a digital communications

infrastructure that could include other media delivery systems such as cable TV and videocassette recorders.

The consortium believes that the most fundamental requirement for a practical digital simulcast HDTV system is "an NTSC-friendly digital modulation system." A new modulation technique developed by the ATRC allows the digital information to be transmitted at low levels of power so that it doesn't interfere with existing NTSC stations. The digital transmission is also relatively resistant to interference from the analog NTSC transmission.

Another key development in the digital simulcast system is the introduction of a highly efficient digital data-compression approach for encoding HDTV. The technique allows the high-definition pictures to be squeezed into the existing broadcasting frequencies, and provides for good picture performance even in the presence of transmission errors.

The consortium hopes that the proposed simulcast HDTV system will be the present-day equivalent of the NTSC's "early superhighway for technology"—"a base system that will provide for technological growth and expansion for many decades."

The original NTSC system, which offered only black-and-white video with mono audio, was extremely versatile. Color was later added to the system, as was multichannel television sound (MTS) stereo audio, a second audio program (SAP) channel for bilingual programming, and closed captioning for the hearing impaired. It is hoped that an HDTV system will turn out to be just as flexible. **R-E**

Take any 3 PROFESSIONAL BOOKS for only \$4.95

when you join the **ELECTRONICS ENGINEERS & DESIGNERS BOOK CLUB**SM

values to \$129.40



10015 \$42.95
Counts as 2



3297 \$39.95



3131 \$26.95



3429 \$29.95



10016 \$39.95
Counts as 2



3279 \$36.95



9319 \$59.50
Counts as 3



3321 \$24.95



3102 \$49.50
Counts as 2



3098 \$44.50
Counts as 2



2672 \$49.50

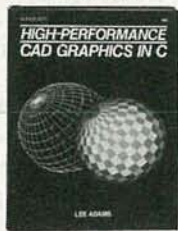

3059 \$34.95
Counts as 2



3151 \$39.95

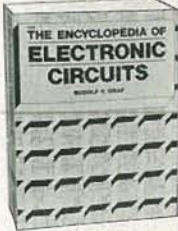

1938 \$60.00
Counts as 2



9813 \$39.95

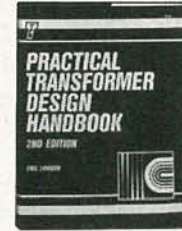

3212 \$34.95



3147 \$38.95



3203 \$44.50
Counts as 2



9244P \$18.95



3140 \$49.95
Counts as 2



9245 \$46.95
Counts as 2



3199 \$52.00
Counts as 2



3037 \$24.95



9305 \$59.50
Counts as 3



8225P \$19.95



9246 \$33.95
Counts as 2

How the Club Works

YOUR BENEFITS: You get 3 books for \$4.95 plus shipping and handling when you join. You keep on saving with discounts up to 50% off as a member.

YOUR PROFESSIONAL BOOKSTORE BY MAIL: Every 3-4 weeks, you will receive the EE&D Book Club News describing the Main Selection and Alternates, as well as bonus offers and special sales, with scores of titles to choose from.

AUTOMATIC ORDER: If you want the Main Selection, do nothing and it will be sent to you automatically. If you prefer another selection, or no selection at all, simply indicate your choice on the reply form provided. You will have at least 10 days to decide. As a member, you agree to purchase at least 3 books within the next 2 years and may resign at any time thereafter.

BONUS BOOKS: Starting immediately, you will be eligible for our *Bonus Book Plan*, with savings of up to 80% off publishers' prices.

IRONCLAD NO-RISK GUARANTEE: If not satisfied with your books, return them within 10 days without obligation!

EXCEPTIONAL QUALITY: All books are quality publishers' editions especially selected by our Editorial Board. (Publishers' Prices Shown)

Your source for quality, affordable and timely authoritative engineering books.



ELECTRONICS ENGINEERS & DESIGNERS BOOK CLUBSM
Blue Ridge Summit, PA 17294-0860

YES! Please accept my membership in the *Electronics Engineers & Designers Book Club* and send the 3 volumes I have listed below, billing me \$4.95. If not satisfied, I may return the books within 10 days without obligation and have my membership cancelled. I agree to purchase at least 3 books at regular Club prices during the next 2 years, and may resign any time thereafter. A shipping/handling charge and sales tax will be added to all orders.

Name _____
Address _____
City _____
State _____ Zip _____ Phone _____
Signature _____

Valid for new members only. Foreign applicants will receive special ordering instructions. Canada must remit in U.S. funds. This order subject to acceptance by the *Electronics Engineers & Designers Book Club*. RPIF391

All books are hardcover unless number is followed by a "P" for paperback.
©1991 EEDBC, Blue Ridge Summit, PA 17294-0860

● **RCA adopts VCR Plus+.**

VCR Plus+, the instant VCR-programming system keyed to special code numbers printed in program listings of newspapers and some editions of *TV Guide* (**Radio-Electronics**, October 1990), will be built into some models of RCA VCR's, according to manufacturer Thomson Consumer Electronics. The program code listings premiered last December in some 30 newspapers and reports at that time indicated a sellout of the \$59.95 remote-control gadget, which could program most VCR's and cable boxes. The version to be built into RCA VCR's will use on-screen prompts. It won't program cable boxes, however.

● **Is it really stereo?** Some TV sets that are advertised as receiving "broadcast TV stereo" are not delivering the goods, according to dbx Technology Licensing, which administers patent rights on one component of the multichannel TV sound (MTS) system. Those sets have stereo amplifiers and two sets of speakers—the necessary ingredients for stereo sound—but fail to properly decode the received TV audio signal, the licensing company says.

When the MTS standard was adopted by an all-industry committee in 1983, a major component was a companding, or noise-reduction, system. The dbx system was chosen, and stations broadcasting with stereo audio were required to encode the signal using the dbx process. To properly receive the audio signal in stereo, according to the committee, receivers were to include a dbx decoding system. Some TV sets being marketed today don't use dbx decoding, employing instead other types of expanding circuitry or simply a filter. The purpose, presumably, is to save money, including the licensing fee. However, the chief engineering official of one TV-set manufacturer that *does* use dbx throughout its line maintains that use of dbx circuitry adds a maximum of only \$2 to the cost of a set, or perhaps 10% to 15%



FAROUDJA's CFD-3 decoder is part of the SuperNTSC system.

of the cost of adding stereo (dual amplifiers and extra speakers).

The dbx licensing organization and some set manufacturers maintain that receivers that don't use dbx have as little as 3- to 4-dB of stereo separation under some conditions—not enough to provide any noticeable stereo effect—and can add noise, "pumping" effects, and wandering or shifting sound in many cases. dbx Technology Licensing calls that "pseudo stereo" and says it plans to initiate an advertising and public-relations campaign to urge buyers to insist on TV receivers with dbx decoders. Manufacturers of TV brands that don't use dbx in some of their sets have steadfastly refused to comment on the situation.

● **SuperNTSC.** As we went to press, SuperNTSC was scheduled for a nationwide test as an alternative to high-definition TV. SuperNTSC, developed by Yves Faroudja, who designs picture-clarifying broadcast systems, uses many different technologies to produce the best possible picture from the existing National TV System Committee (NTSC) color standard. Backed by ABC, Continental Cablevision, General Instrument, Scientific-Atlanta, Viacom, Westinghouse, and other powerhouses in broadcasting and cable, the system uses a combination of image-processing techniques to remove artifacts from the NTSC picture. In addition, signals are originated in non-interlaced scanning at 1,050 lines per second and converted to a standard 525-line NTSC signal just before transmission. A standard receiver will display a conventional image, but a SuperNTSC set will capitalize on all of the picture im-

provements and convert the picture back into 1,050 non-interlaced lines. According to inventor Faroudja, a SuperNTSC decoder should add about \$300 to the cost of a TV set.

● **Big-screen sets grow.**

Although 1990 was the first year in the last eight in which TV set sales didn't set a record, large-screen set sales rose. An analysis of sales figures for last year's first nine months shows that table-model sets in the 27-to-29-inch screen sizes were up 26.4% from the same period in 1989, while the 30-inch-and-up category rose about 96%. All sizes below 27-inch, except 20-inch, declined (and 20-inch was up just 1%). Projection-TV sales set a new record in 1990, and for the first nine months were up nearly 30%.

Confirming the trend to higher-value TV sets in 1990 were figures on sales for January through October. In that period, multichannel TV sound (MTS) was built into 31.7% of all sets sold, up from 27.6% in the comparable period of 1989.

● **SkyPix.** The 80-channel direct satellite-broadcasting system, which bills itself as "the first in-home video store," plans to start broadcasting next summer and is already lining up retailers for its complete receiver package—dish, decoder, and everything needed to convert a standard TV set to receive its DBS signal—which will carry a list price of \$699. SkyPix's compressed signals will include 40 to 50 channels of pay-per-view movies, according to its developers, and will transmit a picture with 480 lines of horizontal resolution, considerably better than Super VHS or laserdisc. **R-E**

A Shocking Offer!

Now for the first time in CIE's 56 year history you do not have to be enrolled at CIE to receive our introductory Electronic and Electricity Lesson Modules. Available for a limited time to non-students for the shockingly low price of only \$99.50.

With CIE's patented AUTO-PROGRAMMED method of learning you'll quickly learn and then master the basics of electronics and electricity and then move on to... DC/AC circuit theories, fundamentals of bi-polar junction transistors (BJT), field effect transistors (FET), wiring, diagram and schematic readings, component identification, soldering techniques... and much, much, more.

Your commitment to CIE ends with your payment, but CIE's commitment to your success just begins when you receive your

39 lessons, exams, binders and equipment. This special introductory price includes all the benefits and assistance CIE normally extends to its students and graduates. You'll be entitled to unlimited access to CIE's faculty and staff to assist you in your studies via a toll free 800 number six days a week, 24-hour turnaround on grading your submitted exams, CIE Bookstore privileges, a patented learning method,

reference library, a student, faculty and alumni electronic bulletin board and a free issue of CIE's school newspaper The Electron. All this knowledge and support will put you on the road to understanding digital electronics, microprocessing principles, computer systems, telecommunications, and much, much, more.



**All This and Much More
For ONLY!**

\$149⁵⁰

- Free Issue of The Electron
- Build your personal burglar alarm
- Instructors available 6 days a week
- 20 lesson books containing 39 theory and hands-on training lessons and exams.

- Bookstore Privileges
- Patented Learning Method
- Electronic Bulletin Board
- 24-Hour Grading

Yes, send me CIE's 39 Introductory Electronic and Electricity Lessons and Equipment.

Name: _____

Address: _____

City: _____ Apt. #: _____

State: _____ Zip: _____

Age: _____ Phone (_____) _____

Total Merchandise: \$149.50

Ohio Residents add 7% Sales Tax: _____

California Residents add 6-1/2% Sales Tax: _____

Total this order: _____

Method of Payment: Amount Enclosed . . . \$ _____

Personal Check or Money Order

Master Card Visa

Card Expiration Date: _____

Signature _____



BOOKSTORE

1776 East 17th Street
Cleveland, Ohio 44114
(216) 781-9400

BK03



CHARGE BY PHONE!



9 AM to 4:30 PM Eastern Time; from Ohio 1-800-523-9109
from all other states 1-800-321-2155

What's you

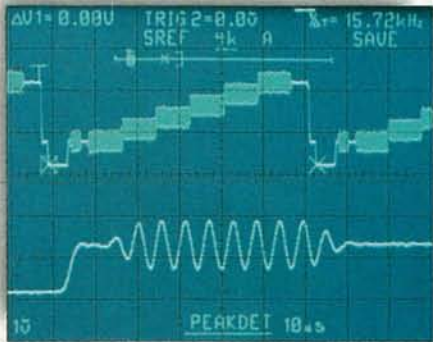

Analyzing TV and complex video signals?

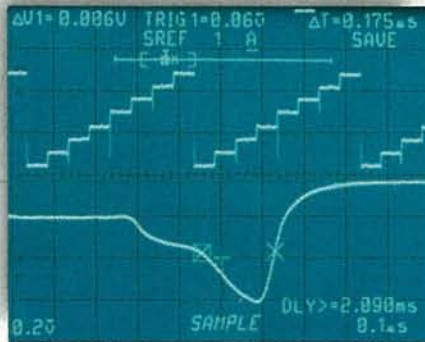

Uncovering elusive glitches?

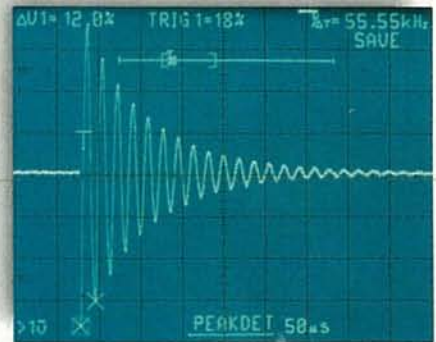

Capturing single-shot events?

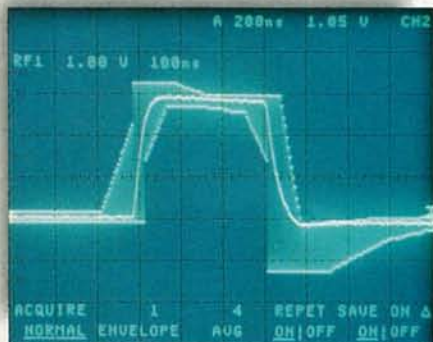

Testing telecommunications signals?



Finding aberrations buried within a signal?

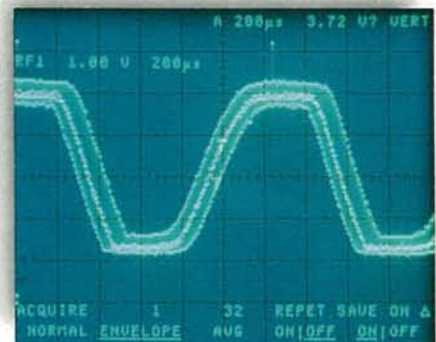

Automatic PASS/FAIL testing?

You can't depend on banner specs alone to solve problems like these.

Whether you're trying to measure waveform parameters or analyze long data streams, identify infrequent events or track down glitches as narrow as 2 ns — there's all the difference between the depth of Tek troubleshooting and the trade-offs in other DSOs that compromise your results.

Spec for spec, feature for feature, no other company offers the credentials Tek does to

effectively match DSO performance to your application needs. Whatever your criteria, you'll find a perfect solution in our line of problem-solving portable DSOs, from 10 to 500 MS/s.

Select the features to support your application. Tek DSOs offer a diverse set of capabilities including peak detect to uncover elusive glitches. Fast update rate for live signal display. Combined analog/digital operation for real-time verification of your

problem?

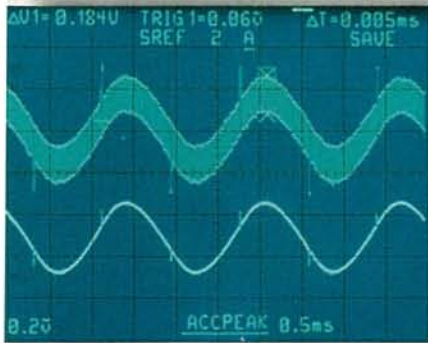

Characterizing signal noise?

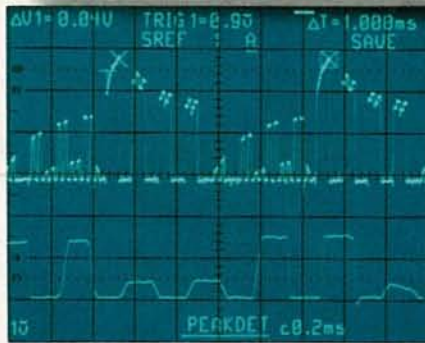

Capturing and analyzing long data streams?

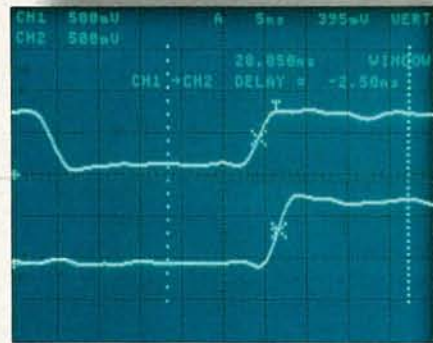

Measuring timing relationship between signals?

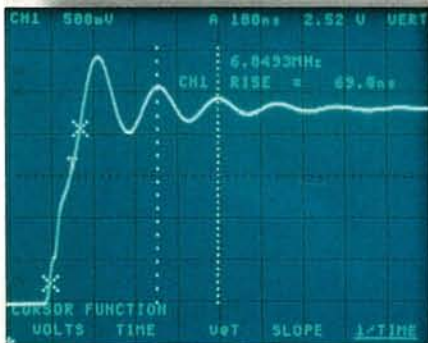

Performing complex measurements automatically?

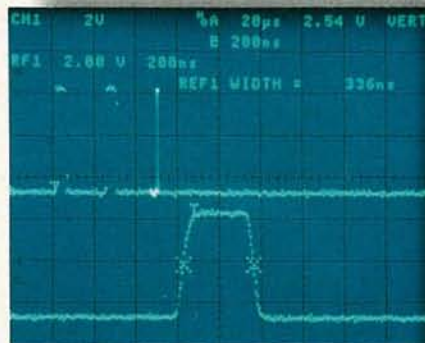

Expanding glitches for close analysis?

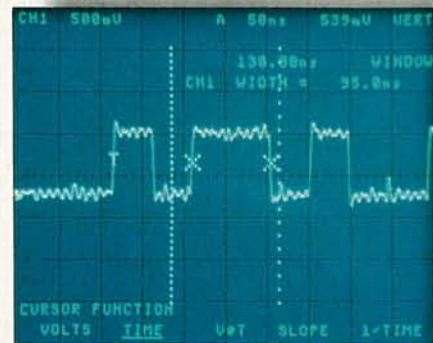

Windowing in on signal details?

signal. Or Save on Delta to automatically verify that all parts of your signal fall within prescribed limits. Best of all, Tek's line of 100 MS/s digitizing scopes start at just \$3995.

To find out which Tek scope is right for you, contact your Tek representative, return the card or call Tek direct. We can answer your questions and show you a scope that doesn't just look good on paper. It makes your toughest troubleshooting challenges routine.

1-800-426-2200



One company measures up.

Tektronix
COMMITTED TO EXCELLENCE

CIRCLE 92 ON FREE INFORMATION CARD

ASK R-E

Write to Ask R-E, Radio-Electronics, 500-B Bi-County Blvd., Farmingdale, NY 11735

NO COLOR TITLES

I recently purchased a program called "Video Titler Plus" for my old Apple II Plus Computer. It's produced by a company called Datasoft and is designed to let you create graphic titles on the computer and then transfer them to your VCR. The problem I'm having is that none of the titles show up in color on my TV. Is there any way to get my Apple graphics recorded in color without actually pointing a camera at the computer screen?— M. Marks, Pittsburgh, PA

Even though some may think of electronics as an exact science, the best answer I can give you in this case is a definite maybe. It may not be all that satisfying, but what can I tell you?

Since you can get the titles up on the screen, there's evidently no problem with the software, which is a good thing since I believe that the company who produced it is out of business. The reason you're having a problem getting color in the recorded image is, as you suspect, that the old Apple II Plus, as well as the newer Iie and IIgs, don't generate interlaced video.

If you throw the output of the Apple's composite video port on a scope, you'll see that it's real close to NTSC, but when you're talking about video, a miss is as good as a mile.

I have an Apple II Plus and, back in the old days, used to run the video through a VCR to get an instant replay on some computer games. Some VCR's and TV's (usually the older ones), would swallow the Apple video and produce color images. The newer video equipment is much more finicky about details like interlace and, if the waveform isn't a real close match to NTSC, color disappears. It's amazing how important half lines can be.

I can offer you three possibilities for solving the problem but I'm not going to guarantee that any of them

will work. The first, and most obvious, is to try an older VCR, or at least a different one. Based on the experience I had, cheaper models with fewer features seem to be a better choice.

The second option is to try adjusting the operating frequency of the Apple itself. That's fairly simple to do since there's a small trimmer capacitor in the main clock circuit located between A1 and B1 on the motherboard. Those are Apple's grid coordinates and you'll find them along the edges of the board. If the Apple is slightly off frequency, the burst frequency will be off as well and the difference may be enough to keep your VCR from recognizing it.

You should use a scope for this but, if you don't have one, a bit of freehand experimentation can't hurt anything. Just be sure to mark the original position of the trimmer in case you run into problems. A second trimmer is on the motherboard at location G14 and you can play around with that one as well. It changes the phase angle of the burst and will change the hue of the colors on the screen. It shouldn't do anything to help your problem, but then again, you never know.

If none of those two work, your only available option is to look around for some hardware that will solve the problem. Quite frankly, I wouldn't hope for much since the computer is rather old. It's true that there are some expansion slot similarities between it and the later Iie, but that whole market isn't what it used to be. Check with some Apple magazines and, if all else fails, you might try contacting Apple itself. Good luck.

A LONG PLAYING RECORDER

How would I modify an ordinary cassette recorder to make it into a super long-playing recorder? I understand only one or two electronic components are necessary.— L. Krenek, La Grange, TX

I haven't had the occasion to take apart a wide variety of cassette re-

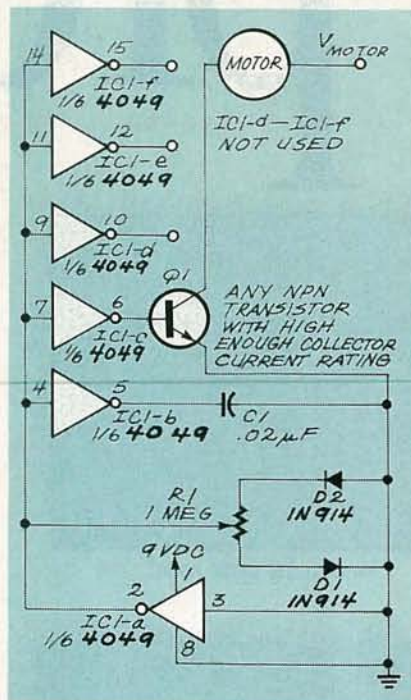

FIG. 1—YOU CAN USE THIS CIRCUIT TO control the speed of a small DC motor.

orders but the ones I have seen are easily modified to increase the recording time. Before we get any further along with this, you should NEVER try to modify store-bought equipment without either a lot of paperwork, a lot of experience, or a lot of nerve. Consumer stuff has gotten so sophisticated that opening the case often requires a manual.

But seriously folks, most good cassette recorders can be modified without adding any components at all. The motor has a tachometer on it that the cassette's circuitry uses to monitor the speed of the motor and make sure that the speed remains constant. Some motors have a small AC generator running off the motor shaft inside the motor housing, and others have a small pickup head mounted outside the motor that gets pulses from a metal wheel attached to the motor shaft.

In any event, the frequency generated by the tachometer is fed to a small circuit that converts it to a voltage and measures the resulting value

continued on page 92

ELENCO & HITACHI PRODUCTS AT DISCOUNT PRICES

NEW! RSOs (Real-Time & Storage Oscilloscopes) From HITACHI **NEW!**
The RSO - its the new solution
View, Acquire, Test, Transfer and Document Your Waveform Data

4-Channel, 100MS/s Model **Introductory Price**
100MS/s (25MS/s on 4 channels simultaneously), 100MHz, 4kw x 1ch., 2kw x 2ch., 1kw x 4ch. VC-6145 \$4,695.00

Compact, Full Feature Models
40MS/s, 100MHz, 4kw x 1ch., 2kw x 2ch. VC-6045 \$3,049.00
20MS/s, 50MHz, 2kw x 2ch. VC-6025 \$2,295.00

Low Cost/High Value Models
20MS/s, 50MHz, 2kw x 2ch. VC-6024 \$2,049.00
20MS/s, 20MHz, 2kw x 2ch. VC-6023 \$1,749.00

RSOs from Hitachi feature such functions as roll mode, averaging, save memory, smoothing, interpolation, pretriggering, cursor measurements, plotter interface, and RS-232C interface. With the comfort of analog and the power of digital.



V-212 Hitachi Portable Scopes
\$435
DC to 50MHz, 2-Channel, DC offset function, Alternate magnifier function
V-525 CRT Readout, Cursor Meas. \$1,025
V-523 Delayed Sweep \$995
V-522 Basic Model \$895

V-422 40MHz Dual Trace \$795

20MHz Elenco Oscilloscope



\$375
MO-1251
• Dual Trace
• Component Tester
• 6" CRT
• X-Y Operation
• TV Sync
• 2 p-1 Probes

FREE DMM

with purchase of
ANY SCOPE

SCOPE PROBES

P-1 65MHz, 1x, 10x \$19.95
P-2 100MHz, 1x, 10x \$23.95

Compact Series Scopes



Delayed Sweep
Lightweight (13lbs)
2mV Sens
3 Yr Warranty

Model V-1065
Shown

This series provides many new functions such as CRT Readout, Cursor measurements (V-1085/1065/665), Frequency Ctr (V-1085), Sweetime Autoranging and Trigger Lock using a 6-inch CRT. You don't feel the compactness in terms of performance and operation.

V-660 60MHz Dual Trace \$1,195
V-665 60MHz Dual Trace w/Cursor \$1,345
V-1060 100MHz Dual Trace \$1,425
V-1065 100MHz Dual Trace w/Cursor \$1,695
V-1085 100MHz Quad Trace w/Cursor \$2,045
V-1100A 100MHz Quad Trace w/Cursor \$2,295
V-1150 150MHz Quad Trace w/Cursor \$2,775

Elenco 35MHz Dual Trace Good to 50MHz \$495



MO-1252
• High luminance 6" CRT
• 1mV Sensitivity
• 6KV Acceleration Voltage
• 10ns Rise Time
• X-Y Operation • Z Axis
• Delayed Triggering Sweep
• Includes 2 P-1 Probes

All scopes include probes, schematics, operators manual, and 3 year (2 yrs for Elenco scopes) world wide warranty on parts & labor. Many accessories available for all Hitachi scopes. Call or write for complete specifications on these and many other fine oscilloscopes.

WE NOW CARRY COMPLETE LINE OF FLUKE MULTIMETERS Models

21F 83
23F 85
25F 87
27F 8050A
73 8060A
75 8062A
77F + More

CALL FOR SPECIAL PRICING

True RMS 4 1/2 Digit Multimeter M-7000 \$135
.05% DC Accuracy
.1% Resistance with Freq. Counter and deluxe case



10 Function Multimeter CM-365 \$65
AC + DC Voltage & Amps
Resistance to 2000MΩ
Diode, Logic, & Trans test
Capacitance to 200uF



Digital Capacitance Meter CM-1550 \$58.95
9 Ranges
.1pF-20,000uF
.5% basic acy
Zero control with case



Digital LCR Meter LC-1801 \$125
Measures:
Coils 1uH-200H
Caps .1pF-200uF
Res .01-20M

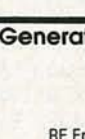

Function Generator Blox #9600 \$28.95

Provides sine, triangle, square wave from 1Hz to 1MHz
AM or FM capability



Triple Power Supply XP-620 Assembled \$65 Kit \$45



2 to 15V at 1A,
-2 to -15V at 1A
(or 4 to 30V at 1A)
and 5V at 3A
Contains all the desired features for doing experiments.
Features short circuit protection, all supplies.

Wide Band Signal Generators



SG-9000
\$129

RF Freq 100K-450MHz
AM Modulation of 1KHz
Variable RF output

SG-9500 w Digital Display and 150MHz built-in Counter \$249

AC Current Meter ST-1010 \$69.95
1000 Amps
Data & Peak hold
8 Functions
Deluxe Case



Decade Blox #9610 or #9620 \$18.95
#9610 Resistor Blox
47 ohm to 1M & 100K pot
#9620 Capacitor Blox
47pF to 10MFD



Quad Power Supply XP-580 \$59.95
2-20V at 2A
12V at 1A
5V at 3A
-5V at .5A
Fully regulated and short circuit protected
XP-575 without meters \$39.95



LEARN TO BUILD AND PROGRAM COMPUTERS WITH THIS KIT!

INCLUDES: All Parts, Assembly and Lesson Manual



Model
MM-8000
\$129.00

Starting from scratch you build a complete system. Our Micro-Master trainer teaches you to write into RAMs, ROMs and run a 8085 microprocessor, which uses similar machine language as IBM PC. You will write the initial instructions to tell the 8085 processor to get started and store these instructions in permanent memory in a 2816 EPROM. Teaches you all about input and output ports, computer timers. Build your own keyboard and learn how to scan keyboard and display. No previous computer knowledge required. Simple easy to understand instruction teaches you to write in machine language.

ROBOTICS KIT FOR ABOVE (MM-8010) \$71.95

Digital Triple Power Supply XP-765 \$249
0-20V at 1A
0-20V at 1A
5V at 5A

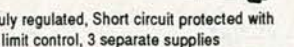

Fully regulated, Short circuit protected with 2 limit control, 3 separate supplies

XP-660 with Analog Meters \$175

GF-8016 Function Generator with Freq. Counter \$249
Sine, Square, Triangle
Pulse, Ramp, .2 to 2MHz
Freq Counter .1 - 10MHz



GF-8015 without Freq. Meter \$179

WE WILL NOT BE UNDERSOLD!
UPS Shipping: 48 States 5%
(\$10 Max) IL Res., 7% Tax



C & S SALES INC.
1245 Rosewood, Deerfield, IL 60015
(800) 292-7711 (708) 541-0710

15 Day Money Back Guarantee
2 Year Warranty Prices subject to change
WRITE FOR FREE CATALOG

CIRCLE 109 ON FREE INFORMATION CARD

MARCH 1991

AOR Scanners.

Great Performance. Great Service. Great Value.

Free Freight
25-Day Money-Back Guarantee
Toll-Free Service and Support
No Credit Card Surcharge
One Year Warranty



AR1000

\$499

1000 Channels. 8-600MHz, 805-1300MHz

Standard Features:

- Extremely compact size.
- Continuous coverage (except UHF TV 600-805)
- Antenna attenuator switch, 10db.
- Manual tuning knob.
- Earphone jack, 3.5mm.
- AM, FM and wide band FM tuning modes.
- Backlighted LCD display.
- 10 Scan Banks, 10 Search Banks.
- Selectable Priority Channel.
- Delay, Hold Features.
- Selectable Search Increments, 5-955KHz.
- Permanent memory backup.
- 4 AA Ni Cad batteries included.
- AC adaptor/charger.
- Carry Case.
- Cigarette Lighter Charger.
- Belt Clip.
- Earphone.

Options:

- External Speaker. Mobile Mount. MS190 \$19.50
- Extended Warranty. 2/3 yrs \$45/\$55

Specifications:

- Coverage: 8-600, 805,1300MHz
- Sensitivity: .35uV NFM, 1.0uV WFM, 1.0AM
- Speed: 20 ch/sec. scan. 40 ch/sec. search
- IF: 561.225, 58.075, 455KHz or 10.7MHz
- Increments: 5 to 955KHz selectable/ 5 or 12.5 steps.
- Audio: .4 Watts
- Power: Input 9 - 13.8 V. DC
- Antenna: BNC
- Display: LCD
- Dimensions: 6 7/8H x 1 3/4D x 2 1/2W. 12oz wt.

AR950

\$239

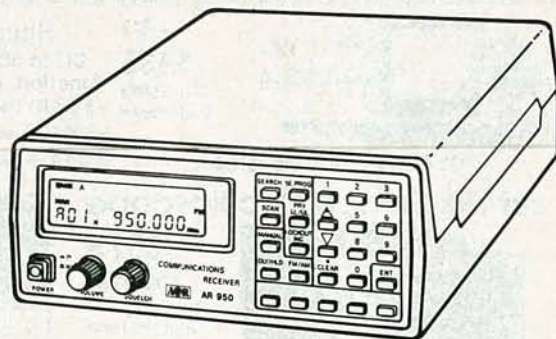

100 Channels. Low, Air, High, UHF & 800MHz.

Standard Features:

- Extremely compact size.
- Unrestricted 800MHz coverage.
- 100 channels permanent memory.
- Earphone Jack & Attenuator.
- Delay, Hold features.
- Channel 1 Priority.
- 5 Scan Banks, 5 Search Banks.
- Telescopic and Flexible Antennas w/ BNC connector.
- AC & DC Power cords w/ mtng hardware.
- One Year Limited Warranty.

Options:

- Base type antenna
25 to 1000MHz w 50' coax. AS300 \$59.95
- Mag Mnt Mobile Antenna. 15' coax. MA100 \$25.00
- Cigarette Lighter power adaptor. CP100 \$4.00
- External Speaker
with mobile mount. MS100 \$19.50
- Extended Warranty. 2/3 yrs \$40/\$55

Specifications:

- Coverage: 27-54, 108-174, 406-512, 830-950MHz
- Sensitivity: .4uV Lo,Hi. .8uV Air. .5uV UHF. 1.0uV 800
- Scan Speed: 15 ch/sec.
- IF: 21.4MHz, 455KHz
- Increments: 10,12.5,25,30
- Audio: 1W
- Power: 12.8VDC, 200MA
- Antenna: BNC
- Display: LCD w/backlight
- Dimensions: 2 1/4H x 5 5/8W x 6 1/2D. 14oz wt.

We offer 100's of communications products.

AR3000

\$995

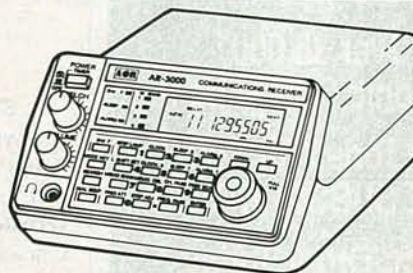

400 Channels. 100KHz to 2036MHz.

Standard Features:

- Extremely compact size.
- Continuous coverage
- Attenuation Programmable by Channel.
- Manual tuning knob.
- Tuning increments down to 50Hz.
- AM, FM, wide band FM, LSB, USB, CW modes.
- Backlighted LCD display.
- 4 Scan and Search Banks, Lockout in Search.
- 4 Priority Channels.
- RS232 control through DB25 connector.
- Delay, Hold Features.
- 15 band pass filters, GaAsFET RF amp.
- Sleep and Alarm Features.
- AC adaptor/charger. DC power cord.
- Telescopic Antenna.

Options:

- | | | |
|---------------------------------|-------|----------|
| Earphone. | EP200 | \$2.00 |
| External Speaker. Mobile Mount. | MS190 | \$19.50 |
| Extended Warranty. 2/3 yrs. | | \$65/75 |
| Mobile Mounting Bracket. | MM1 | \$14.90 |
| RS232 Control Package | SCS3 | \$295.00 |
- (software & cable) offers spectrum display and database.

Specifications:

- | | |
|--------------|---|
| Coverage: | 100KHz - 2036MHz |
| Sensitivity: | .35uV NFM, 1.0uV WFM,
1.0AM/SSB/CW |
| Speed: | 20 ch/sec. scan. 20ch/sec. search |
| IF: | 736.23, (352.23) (198.63) 45.0275, 455KHz |
| Increments: | 50Hz and greater |
| Selectivity: | 2.4KHz/-6db (SSB) 12KHz/-6db
(NFM/AM) |
| Audio: | 1.2 Watts at 4 ohms |
| Power: | Input 13.8 V. DC 500mA |
| Antenna: | BNC |
| Display: | LCD |
| Dimensions: | 3 1/7H x 5 2/5W x 7 7/8D Wt. 2lb 10oz. |

AR2500

\$499



2016 Channels. 1 MHz to 1500 MHz

Standard Features

- Continuous coverage
- AM, FM, wide band FM, & BFO for SSB, CW.
- 64 Scan Banks.
- 16 Search Banks.
- RS232 port built in.
- Includes AC/DC pwr crd. Antenna, Mntng Brckt.
- One Year Limited Warranty.

Options:

- | | | |
|---------------------------------|-------|----------|
| Earphone. | EP200 | \$2.00 |
| External Speaker. Mobile Mount. | MS190 | \$19.50 |
| Extended Warranty. 2/3 yrs. | | \$65/75 |
| Mobile Mounting Bracket. | MM1 | \$14.90 |
| RS232 Control Package | SCS2 | \$295.00 |
- (software & cable) offers spectrum display and database.

Specifications:

- | | |
|--------------|---------------------------------------|
| Coverage: | 1 MHz - 1500MHz |
| Sensitivity: | .35uV NFM, 1.0uV WFM,
1.0AM/SSB/CW |
| Speed: | 38 ch/sec. scan. 38 ch/sec. search |
| IF: | 750.00, 45.0275, 5.5MHz 455KHz |
| Increments: | 5,12,5,25 KHz |
| Audio: | 1.2 Watts at 4 ohms |
| Power: | Input 13.8 V. DC 300mA |
| Antenna: | BNC |
| Display: | LCD, backlighted. |
| Dimensions: | 2 1/4H x 5 5/8W x 6 1/2D Wt. 1lb. |

To Order Call 1•800•445•7717

In All 50 States and Canada. 24 Hours a Day. Fax Orders: 1-800-448-1084, 24 Hours a Day.

ACE Communications Monitor Division 10707 E. 106th Street, Fishers, IN 46038

Int'l Voice# 317-842-7115. Int'l Fax# 317-849-8794.

Service and Support Lines: Mon-Fri 9a.m. to 9p.m., Saturday 10-4. EST

MasterCard, Visa, American Express, Checks, Approved P.O.'s. & C.O.D. (add 5.00)

Prices and specifications subject to change.

FREE CATALOG

Call (800) 992-9943

Over 35,000
Electronic Components

Call Today for Your
FREE SUBSCRIPTION

If You Order Today,
WE SHIP TODAY!!



**MOUSER
ELECTRONICS**

(800) 992-9943

Stocking Locations Across America.

CIRCLE 117 ON FREE INFORMATION CARD

Get A Complete Course In

ELECTRONIC ENGINEERING

8 volumes, over 2000 pages, including all necessary math and physics. 29 examinations to help you gauge your personal progress. A truly great learning experience.

Prepare now to take advantage of the growing demand for people able to work at the engineering level.

Ask for our brochure giving complete details of content. Use your free information card number, or write us directly. \$99.95, Postage Included. Satisfaction guaranteed or money refunded.



**Banner
Technical
Books, Inc.**

1203 Grant Ave.
Rockford, IL 61103

CIRCLE 67 ON FREE INFORMATION CARD

LETTERS

Write to Letters, Radio-Electronics,
500-B Bi-County Blvd., Farmingdale, NY 11735

STEREOPHILE RESPONDS

I was interested to read Larry Klein's *Audio Update* in the December issue of **Radio-Electronics**, in which he discussed Bob Carver's attempts to match one amplifier's transfer characteristic to that of another. Opinions are opinions, and Mr. Klein is entitled to draw any conclusion he wishes from *Stereophile* magazine's editorial coverage of Mr. Carver's products. Facts are facts, however, and I was disturbed to see that a responsible and conscientious journalist like Mr. Klein had intentionally or unintentionally misrepresented the facts of *Stereophile*'s involvement with the various "Carver Challenges."

Briefly, here is what happened: Sometime in 1985, Mr. Carver challenged *Stereophile*'s then editor, J. Gordon Holt, and its publisher, Larry Archibald, that he could match the sound of any amplifier they chose with one of his inexpensive "Magnetic-Field" power amplifiers. Mr. Carver did, indeed, visit Santa Fe to try to modify his amplifier so that it matched the sound of an expensive tube design. The degree to which the two amplifiers matched was confirmed using the null test described by Mr. Klein. At first, however, even though the measured null was 35 dB down from the amplifier's output levels (meaning that any difference was at the 1.75% level), Mr. Holt and Mr. Archibald were able to distinguish the Carver from the target amplifier by ear. It was only when Mr. Carver lowered the level of the null between the two amplifiers to -70 dB—a 0.03% difference—that the listeners agreed that the Carver and the reference amplifier were sonically indistinguishable. (The entire series of tests was covered in the October 1985 issue of *Stereophile*.)

Mr. Klein wrote in his column that "Upon reflection, reconsideration, and relistening to the original modified Carver amp plus other samples that Carver had modified similarly, *Stereophile*'s staff decided that the

amplifiers really didn't sound alike after all."

That is not true. Neither Mr. Holt nor I had further access to the original prototype amplifier from the 1985 tests. Some 18 months later, however, *Stereophile* was sent a production version of an amplifier that we had understood Mr. Carver intended to sound and measure identically to the prototype that had featured in the 1985 listening tests, the Carver M-1.0t. Because of that sonic "cloning," the production M-1.0t was advertised as sounding identical to the tube amplifier that had featured in the 1985 *Stereophile* tests.

After careful and independent auditioning of the production M-1.0t, Mr. Holt and I felt that, while it sounded similar to the tube design, it did not sound identical. It certainly could not be said that we deemed it the sonic equivalent of the "very expensive amplifiers"—as Carver's ads said. Measuring the outputs of the two amplifiers at the loudspeaker terminals while each was driving a pair of Celestion SL600 speakers revealed minor frequency-response differences due to the amplifiers having different output impedances. In addition, carrying out a null test between the production M-1.0t amplifier and the reference tube amplifier revealed that, at best, the two amps would only null to -40 dB at 2 kHz, a 1% difference, diminishing to -20 dB below 100 Hz and above 15 kHz, a 10% difference.

Those null figures were not significantly altered by changing the tube amplifier's bias or by varying the line voltage with a Variac. We then borrowed another sample of the M-1.0t from a local dealer and nulled that against the target amplifier. The result was an even shallower null. In the original tests, Mr. Holt and Mr. Archibald had proven to Mr. Carver that they could identify by ear two amplifiers that had produced a 35-dB null. The 1987 measurements reinforced the idea that the production M-1.0t did not sound the same as the target

amplifier.

After being informed of these results, Mr. Carver flew out to Santa Fe at the end of February, 1987, and carried out a set of null tests that essentially agreed with our measurements, a fact confirmed by Mr. Carver in a letter published in *Stereophile*. "... the null product between the amplifiers ... is 28 dB, not 70 dB! Your tests showed this, and so did mine," he wrote. He went on to say that "Since my own research has shown that the threshold for detecting differences is about 40 dB, I knew there was enough variance between the amps to be detectable by a careful listener." Mr. Carver then asked us to participate in a series of single-blind tests comparing the production M1.0t with the tube amplifier, with himself acting as the test operator. We agreed, and Mr. Holt proved to be able to distinguish the two amplifiers by ear alone in those tests—also discussed in a letter from Mr. Carver published in *Stereophile*.

Despite the fact that the M-1.0t didn't sound the same as the target tube amplifier, we felt it offered a very high power output for the price. It therefore became a regularly recommended amplifier in *Stereophile's* bi-annual "Recommended Components" feature.

Far from "recanting" their original findings, as stated by Mr. Klein, *Stereophile's* staff reported what they had measured and what they had heard under carefully controlled conditions regarding the performance of the production Carver M-1.0t amplifier—just as they do with any component being reviewed. The fact that those findings were at odds with their earlier experience can be explained by the fact that the amplifiers auditioned were not identical: The 1985 tests involved a hand-tweaked prototype based on a Carver M-1.5 chassis; the 1987 tests involved a sample M-1.0t taken from the production line.

Contrary to what was suggested by Mr. Klein, *Stereophile's* premise is not that there are "mysterious audible differences that differentiate audiophile equipment from that produced by 'mass merchandisers' such as Carver." Indeed, as the magazine's editor, I feel that all audible differences can ultimately be explained by measurement, though showing the causal connection between what is heard and what is measured is not a

trivial task. But it is important to try, as Mr. Carver himself said in the February 1990 *Stereophile* interview.

In his column, Mr. Klein drew his own conclusion from those "Carver Challenges:" that a magazine like *Stereophile* has to deny Mr. Carver's achievement on the grounds that "it wipes out the justification for overpriced and overdesigned high-end audio equipment." I draw a different, two-fold, conclusion. First, if a high-priced amplifier sounds better and measures better, its purchase is justifi-

able. Second, while it would indeed appear possible for Mr. Carver, on an individual, hand-tweaked basis, to achieve a null of -70 dB between two entirely different amplifiers, routinely repeating that feat in production is not possible (something implied by Mr. Carver's own statements). And, if it is not possible, then it is likely that such amplifiers could sound different from one another.

JOHN ATKINSON
Editor, *Stereophile*
Santa Fe, NM

The World's Most Popular Probe



Model SP100
100 MHz Switchable 1x-10x **\$45**

More SP100 Probes Have Been Sold Worldwide Than Any Other Probe Ever Made

- For Tektronix, Hewlett Packard, Philips, Leader, B&K, Kikusui, Hitachi, Beckman and other oscilloscopes
- Immediate delivery from distributor stock
- **Economical** - Substantial savings compared to OEM probes
- **Durable** - Unique cable is slim, very flexible and resists breakage
- 10 day return policy - Guaranteed performance and quality

Free cross reference chart for all makes of scopes and probes. Call toll-free for chart and name of your local distributor.

TEST PROBES, INC. **TPI**

9178 Brown Deer Road
San Diego, CA 92121
Toll Free 1-800-368-5719

Learn to troubleshoot and service today's computer systems as you build a fully AT-compatible micro

Train the NRI way—and learn to service all computers as you build your own fully AT-compatible micro, now with 1 meg RAM, 20 meg hard drive, and exciting new diagnostic hardware and software!

Jobs for computer service technicians will almost double in the next 10 years according to Department of Labor statistics, making computer service one of the top 10 growth fields in the nation.

Now you can cash in on this exciting opportunity—either as a full-time industry technician or in a computer service business of your own—once you've mastered electronics and computers the NRI way.

NRI's practical combination of "reason-why" theory and hands-on building skills starts you with the fundamentals of electronics, then guides you through more sophisticated circuitry all the way up to the latest advances in computer technology.

Train with and keep a powerful AT-compatible computer system plus popular Microsoft® Works software!

Only NRI gives you hands-on training with the finest example of state-of-the-art technology: the powerful West Coast 1010ES computer. As you assemble this fully IBM PC/AT-compatible computer from the keyboard up, you actually see for yourself how each section of your computer works.

You assemble and test your computer's "intelligent" keyboard, install the power supply and 5-1/4" floppy disk drive, then interface the high-resolution monitor.

Your hands-on training continues as you install a powerful 20 megabyte hard disk drive—today's most-wanted computer peripheral—now included in your course to dramatically increase the data storage capacity of your computer while giving you lightning-quick data access.



Now includes
AT-compatible,
20 Meg Hard Drive,
and Exciting
New Diagnostic
Package!



Plus you now work with today's most popular integrated software package, Microsoft Works, learning to use its word processing, spreadsheet, database, and communications utilities for your own personal and professional applications. But that's not all.



Only NRI gives you hands-on training with the remarkable R.A.C.E.R. plug-in diagnostic card and QuickTech diagnostic software from Ultra-X—professional, state-of-the-art diagnostic tools that make computer troubleshooting fast and accurate.



Your NRI computer training includes all this: • NRI's unique *Discovery Lab*® for circuit design and testing • Hand-held digital multimeter with "talk-you-through" instructions on audio cassette • Digital logic probe that lets you visually examine computer circuits • The new AT-compatible West Coast 1010ES computer with high-speed 80286 CPU, 101-key "intelligent" keyboard, 1.2 meg high-density floppy drive, 1 meg RAM (expandable to 4 meg), 64K ROM • 20 megabyte hard disk drive • MS-DOS, GW-BASIC, and Microsoft Works software • R.A.C.E.R. plug-in diagnostic card and QuickTech diagnostic software for fast, accurate troubleshooting • Reference manuals with guidelines and schematics

peripheral adapters as parallel printer ports, serial communications ports, video display memory, floppy drives, and hard disk drives.

Only NRI gives you such confidence-building, real-world experience. Only NRI gives you both the knowledge and the professional tools to succeed as today's in-demand computer service technician.

No experience needed, NRI builds it in

NRI training gives you practical, hands-on experience that makes you uniquely prepared to take advantage of today's opportunities in computer service.

You learn at your own convenience in your own home. No classroom pressures, no night school, no need to quit your present job until you're ready to make your move. NRI starts you with the basics, building on that foundation step by step until you have the knowledge and skills you need for success.

And all throughout your training you've got the full support of your personal NRI instructor and the entire NRI technical staff, always ready to answer your questions and help you achieve your training goals.

FREE catalog tells more

Send today for NRI's big, free catalog that describes every aspect of NRI's innovative computer training, as well as hands-on training in other growing high-tech career fields.

If the coupon is missing, write to: NRI School of Electronics, McGraw-Hill Continuing Education Center, 4401 Connecticut Avenue, NW, Washington, DC 20008.

NEW! Training now includes Ultra-X diagnostic hardware and software for quick, accurate troubleshooting!

Now you train with and keep the latest in diagnostic hardware and software: the extraordinary R.A.C.E.R. plug-in diagnostic card and QuickTech diagnostic software, both from Ultra-X. Using these state-of-the-art tools, you learn to quickly identify and service virtually any computer problem on XT, AT 80286/80386, and compatible machines.



You discover how to use the R.A.C.E.R. diagnostic card to identify individual defective RAM chips, locate interfacing problems, and pinpoint defective support chips. Plus you learn to use your QuickTech diagnostic software to test the system RAM and such

IBM is a registered trademark of International Business Machines Corp. R.A.C.E.R. and QuickTech are registered trademarks of Ultra-X, Inc.

SEND TODAY FOR FREE CATALOG



McGraw-Hill Continuing Education Center
4401 Connecticut Avenue, NW
Washington, DC 20008

✓ CHECK ONE FREE CATALOG ONLY

- Microcomputer Servicing
- Automotive Servicing
- PC Systems Analysis
- Industrial Electronics & Robotics
- PC Software Engineering Using C
- Telecommunications
- Small Engine Repair
- Word Processing Home Business
- Electronic Music Technology
- Fiction/Nonfiction Writing
- Air Conditioning, Heating, & Refrigeration
- Computer Programming
- Locksmithing
- Paralegal
- Electrician
- Building Construction
- Desktop Publishing & Design
- Security Electronics
- TV/Video/Audio Servicing
- Bookkeeping & Accounting
- Basic Electronics

For career courses approved under GI Bill, check for details.

Name _____ (please print) _____ Age _____

Address _____

City/State/Zip _____ Accredited Member, National Home Study Council _____ 3-031

EQUIPMENT REPORTS

Fluke Model 45 Dual Display Multimeter

Two displays are
better than
one!



CIRCLE 10 ON FREE INFORMATION CARD

If you're looking for ways to make your measurement tasks easier, then you'll be interested in the model 45 dual-display multimeter from Fluke (John Fluke Mfg. Co., Inc., P.O. Box 9090, Everett, WA 98206.) The *Fluke 45* makes it possible to measure two signal parameters from a single test connection. For example, you can measure the DC output of a power supply at the same time you measure the AC ripple on the output. Or you can measure the voltage of an AC signal at the same time you measure its frequency to, for example, determine an amplifier's frequency response.

The *Fluke 45* is a 5-digit 100,000-count meter that is housed in a plastic case that measures about $3\frac{3}{4} \times 8\frac{1}{2} \times 11\frac{1}{4}$ inches and weighs about 5 pounds. (An optional battery adds about two pounds.) Basic accuracy specifications are impressive: DC voltage, 0.02% DC current 0.05%.

If you're more interested in speed than in accuracy, fast- and medium-speed measurements can be selected from the front panel. While the measurement speed can increase dramatically (20 readings per second in the fast mode as compared to 2½ per second in the slow mode) the accuracy and resolution of the display decreases (5 digits, 99,999 counts in the slow mode as compared to 3½ digits, 3000 counts in the fast mode).

What sets the *Fluke 45* apart from the meter you have on your benchtop

is its dual display. All measurement functions, including AC and DC voltage and current readings, resistance, and frequency, can be displayed on either the primary or the smaller secondary readout.

Function modifiers increase the versatility of the meter, and can speed up some important measurements (although they can be used only with the primary display). For example, when the REL or relative-readings modifier is used, the display shows the difference between the relative base and the input signal. If the relative base is 1000 ohms and the current reading is 1200 ohms, the display will show 200 ohms.

The dB modifier takes a voltage measurement, converts it to dBm (decibels measured with respect to one milliwatt) and displays the result on the primary display. The *reference impedance* can be set to any of 21 values from 2 ohms to 8000 ohms. When the reference impedance chosen is 2, 4, 8, or 16 ohms, the meter can be used to make audio power measurements.

The HOLD modifier lets you hold a measurement on the display when you might not want to take your eyes off the probes to read the display. It can be used separately or in combination with the MN MX or minimum maximum modifier, which lets the meter store the minimum and maximum inputs measured after the modifier is selected.

A compare or COMP modifier gives you an easy way to determine if a measurement falls within an acceptable range of values. Once the acceptable range is input (which can be done in several ways), each measurement shows either "HI," "Low," or "PASS" in the secondary display.

Using the meter

Although the *Fluke 45* provides some complex measurement capabilities, it's quite easy to use. For standard measurements, its operation is intuitive—even when using both the primary and secondary displays at the same time. Some of the more advanced functions take a little experience before their use becomes second nature. The meter's front panel features a clean, logical layout. Its readout is a bright, easy-to-read vacuum-fluorescent display.

The dual display can speed up some test and measurement tasks dramatically. For example, by measuring DC voltage and current (which requires three leads), you can easily check a power supply's load regulation. By measuring AC voltage and current, you can determine a transformer's saturation. The second display can also be used to take full advantage of some of the meter's functions. For example, when the meter is in its minimum/maximum mode, the secondary display can show the current measurement. Or in the hold mode, the running actual value can be shown in the secondary display while the previously held value is shown in the primary display.

The *Fluke 45* offers an RS-232 interface as standard equipment for sending or printing measurement data. Reading rates can be adjusted from one reading every 75 ms to one reading every 5.6 hours. An optional IEEE-488 interface is also available.

Not everyone needs the accuracy and convenience that the *Fluke 45* offers. Even some who do might balk at the unit's suggested retail price of \$635. This is a case, however, of getting what you pay for.

R-E

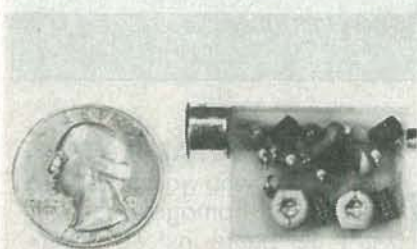

SIMPLY SNAP THE WAT-50 MINIATURE FM TRANSMITTER on top of a 9v battery and hear every sound in an entire house up to 1 mile away! Adjustable from 70-130 MHZ. Use with any FM radio. Complete kit **\$29.95 + \$1.50 S + H.** Free shipping on 2 or more! COD add \$4. Call or send VISA, MC, MO. **DECO INDUSTRIES, Box 607, Bedford Hills, NY 10507. (914) 232-3878.**

CIRCLE 127 ON FREE INFORMATION CARD



GENERAL TECHNICS COMPUTER KITS offer a complete line of 8088, 286, and 386 models. Designed to the highest degree of *quality* and *reliability* available today. They're also fun, easy to build, educational, fully **IBM compatible**, very *powerful*, and at wholesale prices. All kits are pre-tested and include a one year warranty, step by step assembly manual, free software, and a 24 hour tech support/order phone line. For free catalog contact. **GENERAL TECHNICS, P.O. BOX 2676, LAKE RONKONKOMA, NY 11779, or call (516) 981-9473, VISA, MasterCard, American Express, COD**

CIRCLE 191 ON FREE INFORMATION CARD



FREE CATALOG! ELECTRONIC TOOLS & TEST EQUIPMENT. Jensen's new Master Catalog, available free, presents major brand name electronics tools, tool kits, and test instruments, plus unique, hard-to-find products for assembly and repair and custom field service kits available only from Jensen. All fully described and illustrated. Enjoy free technical support and rapid, post-paid delivery anywhere in the Continental USA. **JENSEN TOOLS INC., 7815 S. 46th St., Phoenix, AZ 85044. Phone: 602-968-6231; FAX: 1-800-366-9662.**

CIRCLE 115 ON FREE INFORMATION CARD



CABLE TV CONVERTERS AND DE-SCRAMBLERS SB-3 **\$79.00** TRI-BI **\$95.00** MLD-**\$79.00** M35B **\$69.00** DRZ-DIC **\$149.00.** Special combos available. We ship COD. Quantity discounts. Call for pricing on other products. Dealers wanted. **FREE CATALOG.** We stand behind our products where others fail. One year warranty. **ACE PRODUCTS, P.O. Box 582, Saco, ME 04072 1 (800) 234-0726.**

CIRCLE 75 ON FREE INFORMATION CARD

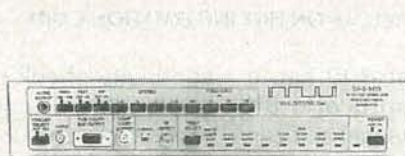

TS-8-MTS VIDEO TEST SIGNAL GENERATOR with Stereo Multi-channel Television Sound (MTS) Option—8 Test Signals, 8 bit digital accuracy, Second Audio Program (SAP), 4 frequencies of tone, RGB Color Bar output, Horizontal and Vertical triggers, channel 3 or 4 RF output. 3 year warranty. TS-8 Price: **\$845.** MTS Option price: **\$245.** Visa, MC, C.O.D. Dealers wanted. Free brochure. **MULTIDYNE ELECTRONICS, INC., 244 Bayville Avenue, Bayville, N.Y. 11709, 1-(800)-765-8200, (516) 628-1495**

CIRCLE 177 ON FREE INFORMATION CARD



NEW XST500 SUPER-MINIATURE FM transmitter uses Surface Mount Technology (SMT)! Own the smallest high performance FM transmitter available. Transmits whispers to any FM receiver up to a mile away. Uses 9V battery. Complete, easy to assemble kit, with SMT components already assembled to circuit board. **\$39.95** Cash, VISA, MC. COD add \$5. **XANDI ELECTRONICS, 201 E. Southern Ave., Suite 114, Tempe, AZ 85282. 1-602-829-8152, (1-800-336-7389 orders only).**

CIRCLE 188 ON FREE INFORMATION CARD

CALL NOW AND RESERVE YOUR SPACE

- 6 x rate \$940.00 per each insertion.
- Fast reader service cycle.
- Short lead time for the placement of ads.
- We typeset and layout the ad at no additional charge.

Call **516-293-3000** to reserve space. Ask for Arline Fishman. Limited number of pages available. Mail materials to: mini-ADS, RADIO-ELECTRONICS, 500-B Bi-County Blvd., Farmingdale, NY 11735.

FAX: 516-293-3315



THE MODEL WTT-20 IS ONLY THE SIZE OF A DIME, yet transmits both sides of a telephone conversation to any FM radio with crystal clarity. Telephone line powered - never needs a battery! Up to 1/4 mile range. Adjustable from 70-130 MHZ. Complete kit **\$29.95 + \$1.50 S + H.** Free Shipping on 2 or more! COD add \$4. Call or send VISA, MC, MO. **DECO INDUSTRIES, Box 607, Bedford Hills, NY 10507. (914) 232-3878.**

CIRCLE 127 ON FREE INFORMATION CARD



APPLIANCE REPAIR HANDBOOKS—13 volumes by service experts; easy-to-understand diagrams, illustrations. For major appliances (air conditioners, refrigerators, washers, dryers, microwaves, etc.), elec. housewares, personal-care appliances. Basics of solid state, setting up shop, test instruments. **\$2.65 to \$7.90 each.** Free brochure. **APPLIANCE SERVICE, P.O. Box 789, Lombard, IL 60148. (312) 932-9550.**

CIRCLE 84 ON FREE INFORMATION CARD

NEW PRODUCTS

Use the Free Information Card for more details on these products.

PORTABLE DSO/DMM.

The battery-powered, 30-megasamples per second model 300 from *Leader Instruments* combines a digital-storage scope and a digital multimeter in one portable unit. The model 300 features dual, add, subtract, and X-Y modes; peak-to-peak voltage of channels 1 and 2 and frequency readout; and automatic setup and auto-ranging for both time base and volts per division for each channel. The instrument measures just $9\frac{7}{16} \times 6\frac{1}{2} \times 1\frac{3}{4}$ inches and weighs about 2½ pounds without batteries. Its large, supertwist LCD readout provides high contrast and a wide viewing angle. On-screen setting conditions that are available include time base, sensitivity for both channels, vertical mode, sweep mode, memory length, trigger slope and source, type of filter, trigger position, bank number, and display mode.

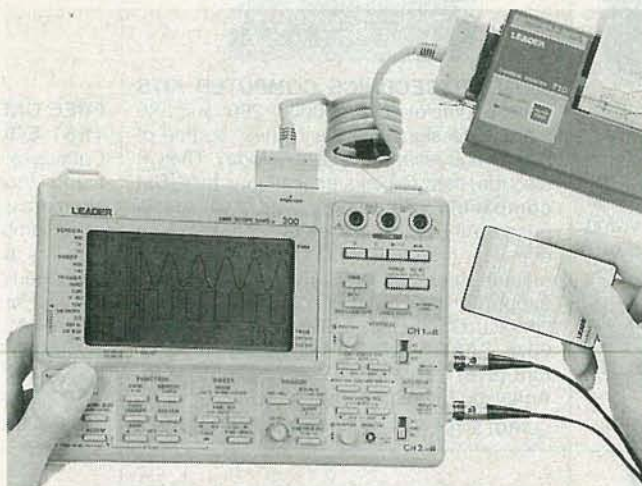

CIRCLE 16 ON FREE INFORMATION CARD

The model 300 has a memory length of 1.8K words per channel and can store 20 waveforms. Up to 80 waveforms can be stored with an optional IC card, which makes it possible to store field information for analysis later in the lab. A data-logger function takes long-term measurements of DC and AC voltage and current, resistance, low-power resistance, diode test, and

continuity check that can be stored in the optional IC card or printed on an optional dedicated printer. An 8-bit logic-analyzer function is handy for remote field-service applications.

The model 300 portable DSO/DMM costs \$1995.00.—**Leader Instruments Corporation**, 380 Oser Avenue, Hauppauge, NY 11788; Tel: 1-800-645-5104 or 516-231-6900 in NY.

SOLDER PASTE KIT. For those who would like to try using homogeneous solder paste instead of flux-core solder wire, *ESP's Kit-5* contains five pre-packaged barrels of solder-paste alloy, molded dispensing tips, and a reusable dispenser for precise solder application. The kit includes 35-gram barrels of 60Sn/40Pb and lead-free 96Sn/4Ag alloys, supplied with both an activated rosin flux and a water-washable flux. Also included is a pre-packaged barrel of the activated rosin-paste flux for desoldering.



CIRCLE 18 ON FREE INFORMATION CARD

The *Kit-5* solder-paste kit costs \$89.00.—**ESP Solder Plus**, 14 Blackstone Valley Place, Lincoln, RI 02865-1145; Tel: 1-800-338-4353.

PORTABLE SIGNAL ANALYZER.

Weighing only seven pounds, *Hewlett Packard's* notebook-sized *HP 3560A* is a fast Fourier transform (FFT)-based, dynamic signal analyzer that provides the measurement speed and functions of a benchtop analyzer. This high-performance portable instrument offers time- and frequency-domain analysis for electronics, vibration, rotating machinery, structural test, acoustics, signal

PC-DIAGNOSTICS CARD.

Designed for service technicians, repair centers, dealers, and manufacturers, *Landmark's KickStart 2* is an advanced, multifunction PC-diagnostics card that combines firmware and hardware in a compact plug-in board. With up to one megabyte of on-board EPROM, it per-

forms both low-level (POST) and advanced (ROM-based) diagnostic tests of the motherboard, memory, and major peripheral controllers. The tests are suitable for diagnosing system failures and burning in systems.

KickStart 2 provides built-in I/O, password protection, and remote testing. The remote function allows a technician to perform on-site testing and password protection activities from a home office using a modem. For testing purposes, a pair of "JumpStart" BIOS ROM's

are provided. The firmware is modular, so customization is possible. Digital LED readouts show the POST codes sent to port 80 and 280. Battery backup keeps configuration and password information intact. Loopback plugs are provided for complete serial- and parallel-port testing.

The *KickStart 2* has a suggested retail price of \$599.00.—**Landmark Research International Corporation**, 703 Grand Central Street, Clearwater, FL 34616; Tel: 813-443-1331; Fax: 813-443-6603.

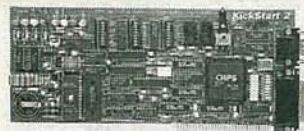

CIRCLE 17 ON FREE INFORMATION CARD

monitoring, and other low-frequency applications. An internal battery pack provides six hours of uninterrupted operation.

The HP 3560A is a two-channel, DC to 40-kHz spectrum/network analyzer with measurement functions including complete alias protection and

Data can also be transported to third-party measurement and analysis packages using the included file utility.

The HP 3560A signal analyzer costs \$7500.—**Hewlett-Packard Company**, Inquiries, 19310 Pruneridge Avenue, Cupertino, CA 95014; Tel: 1-800-752-0900.

EIGHT-OUTLET SURGE SUPPRESSOR. An automatic-shutdown circuit turns off all power if the surge-suppressor circuit in Perma Power's LS-812 fails due to high-voltage or repetitive surges. That automatic disconnection prevents any exposure to unprotected power—an important feature given the usual "out-of-sight" placement of surge protectors. The surge protector has a



CIRCLE 19 ON FREE INFORMATION CARD

digital zoom for high-resolution measurements, and an anti-alias filter that can be adjusted for fast-edge, time-domain measurements. The analyzer provides a 70-dB dynamic range and ± 0.5 -dB amplitude accuracy for spectrum measurements; ± 0.2 -dB, ± 5 -degrees network measurement accuracy; variable frequency resolution from 101 to 1601 lines per display; and on-line zoom, which allows the full resolution of the analyzer to be concentrated anywhere in the 40-kHz measurement range.

The signal analyzer can send trace plots directly to printers and plotters through the rear-panel EIA-232D (RS-232C) connection. It will print to HP LaserJet and QuietJet printers and plotters including the HP 7550A and HP 7475A. It can transfer data from internal memory directly to a printer with a capacity of 500 state/trace combinations. A PC-based data-transport utility converts HP 3560A data to standard-data format for post-measurement analysis by other HP products.



CIRCLE 20 ON FREE INFORMATION CARD

lifetime warranty that extends beyond the unit itself to provide equipment-repair coverage for protected equipment. The surge suppressor features two rows of four outlets in a beige metal case with a 12-foot power cord.

The LS-812 incorporates in a hybrid circuit metal-oxide varistors (MOV's), avalanche diodes, capacitors, and inductors. The LS-812 provides 5-ps response time and high EMI and RFI noise filtering at a low U.L. let-through voltage rating of 330 volts.

The LS-812 surge suppressor has a suggested retail price of \$99.95.—**Perma Power Electronics, Inc.**, 5601 West Howard Ave., Chicago, IL 60648; Tel: 312-763-0763; Fax: 312-763-8330.

PERFECT CABLE CONNECTION !!

Perfect Cable Connection is totally committed to customer satisfaction. Our primary concern is to provide you with the highest quality converters and descramblers at the lowest cost. We employ full time technicians to insure hassle free service and troubleshoot any situation. Call us today and let us prove to you why we are the Perfect Cable Connection.

- 6 months 100% parts & labor
- 24 months warranty available
- Full technical support
- On-line computer system
- 30 days money back guarantee
- Most orders shipped within 24 hours
- Visa, M.C, AMEX - 5%
- Dealers welcome
- C.O.D.

Jerrold 400 DRX 3 DIC WR 1 119 5 89 10 79 20 69 50 65 100 CALL	SA 8536 W R 1 225 5 205 10 185 20 170 50 CALL 100 CALL	Regal RC 83 W R *New* 1 89 10 69 20 65 50 60 100 55	* 99 Ch capacity * Wireless remote * Automatic fine tuning * Parental lock * Made in Japan * Super small * Favorite memory channels	Gen. Mod. J-4, 2 1 39 5 35 10 30 20 27 50 CALL 100 CALL
Filters 1 CALL 10 CALL 5 CALL 20 CALL 50 CALL 100 CALL	Jerrold 450 DRZ 3 DIC WR 1 129 5 99 10 89 20 79 50 CALL 100 CALL	SA 8500 311 W R 1 199 5 175 10 150 20 CALL 50 CALL 100 CALL	Zenith ZTACS All models Call for prices	CRX 5000 3M W R 1 119 5 99 10 79 20 69 50 CALL 100 CALL
Jerrold 400 DRX 3105 W R 1 55 5 49 10 45 50 40	TB-3 1 75 10 48 20 43 50 39 100 35	SA-3B 1 75 10 48 20 43 50 39 100 35	Jerrold 450 DRZ 3 W R 1 68 10 55 20 45 50 40	FTB-3 1 99 10 79 20 65 50 CALL 100 CALL

WE WILL MEET OR BEAT ANY ADVERTISED PRICE IN THIS MAGAZINE.

PERFECT CABLE CONNECTION

702-358-2763
2209 Oddie Blvd., Suite 321
Spark, NV 89431

Turn Your Electronics HOBBY into a CAREER



Love exploring electronics in your spare time? Imagine what it would be like to make a full-time career of it. The demand for qualified electronics technicians has never been greater. Peoples College can give you the qualifications you need.

- Specialized Associate Degree in Electronics Technology
- Computer Servicing
- Microprocessor Technology

Call or write today for a color catalog! There is no obligation and no salesperson will call. Programs in computer programming and computer applications also available.



1-800-765-7247
PEOPLES COLLEGE
OF INDEPENDENT STUDIES

233 Academy Drive • P.O. Box 421768 • Kissimmee, FL 34742-1768
Member D.L. Peoples Group

CIRCLE 176 ON FREE INFORMATION CARD

WARNING!
CABLE BOX DEALERS
 Consider the facts before you buy
 after-market cable equipment

An industry standard defines 25% of all after-market cable boxes do not work when first tested...

All wholesalers advertise low prices...but low prices are not enough. Any price is too high if you're without technical support or quality control.

Now consider that your success as a dealer depends on the satisfaction of your customers.

Wholesale Cable Supply offers services that are near a defined science. And we guarantee 100% satisfaction.

- Monthly Special
- Guaranteed Low Prices
 - State-of-the-Art technical support
 - Top Quality Tested Products
 - Dealer Market Support
- WHOLESALE CABLE SUPPLY**
 Low Price is only the beginning
- | |
|---------------|
| TB-3 or SA-3B |
| 10 lot 48 |
| 20 lot - 43 |
| 50 lot - 39 |
| 100 lot - 39 |
| Z-TAC |
| 10 lot - 149 |

FULLY PROGRAMMABLE POWER SUPPLIES.

Three power supplies from *Fluke* offer features designed specifically for the system environment, including single, dual, and triple output configurations; autoranging for full power capability over the full voltage and current ranges; and extensive protection for the device under test. Each of the power supplies in the *PM 2800 series* provides a one-box power solution for systems by including a GPIB interface, readback, and power module, and offers front-panel

programmability for all functions. In addition, the instruments offer a 99-location internal non-volatile memory, and an autostep function that simplifies the creation of voltage and current test patterns by automatically stepping through the internal memory. A software instrument drive for the *PM 2800 series* is available free of charge.

The modules are available in 30V/10A/60W, 60V/5A/60W, and 60V/10A/120W units. The three power modules, when combined with the single, dual, and triple output configurations, give the user a choice of 11 different models.

Device-under-test protection is provided through programmable over-voltage and over-current protection; a constant current and constant voltage limit to the power delivered to the load; coupled protec-

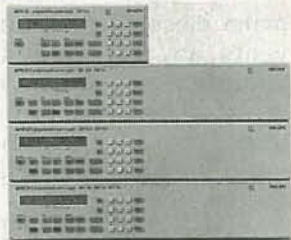

CIRCLE 21 ON FREE INFORMATION CARD

KENWOOD OSCILLOSCOPES

ANALOG OSCILLOSCOPES W/O READOUT

MODEL CS-5135
 40 MHz, Dual Channel.
 Delayed Sweep.
 REG. \$895.00 SALE \$719.95

MODEL CS-5155
 50 MHz, 3 Channel,
 6-Trace, Delayed Sweep.
 REG. \$995.00 SALE \$819.95

MODEL CS-5165
 60 MHz, 3 Channel,
 6-Trace, Delayed Sweep.
 REG. \$1095.00 SALE \$899.95

MODEL CS-2150
 150 MHz, 4 Channel,
 8-Trace, Delayed Sweep.
 REG. \$2395.00 SALE \$1495.95



MODEL CS-4025
 20 MHz, Dual Channel
 Oscilloscope.
 REG. \$495.00
SALE \$349.95

ANALOG OSCILLOSCOPES W/READOUT/CUSORS

MODEL CS-5130
 40 MHz, Dual Channel,
 4-Trace, Delayed Sweep.
 REG. \$1095.00 SALE \$899.95

MODEL CS-5170
 100 MHz, Dual Channel,
 4-Trace, Delayed Sweep.
 REG. \$1695.00 SALE \$1399.95

MODEL CS-6010
 100 MHz, 4 Channel,
 10-Trace, Delayed Sweep.
 REG. \$1995.00 SALE \$1699.95

MODEL CS-6020
 150 MHz, 4 Channel,
 10-Trace, Delayed Sweep.
 REG. \$2395.00 SALE \$1999.95



Products International
 8931 Brookville Rd.
 Silver Spring, MD 20910
 (800)638-2020 (301)587-7824
 FAX# 301-585-5402
 EASY ORDER FAX LINE (800)545-0058

800-638-2020



CIRCLE 184 ON FREE INFORMATION CARD

CABLE - TV

SIGNAL REMOVERS

- FOR ELIMINATION OF SEVERE INTERFERENCE
- FOR "CENSORING" OF ADULT BROADCASTS



FOR FULL DESCRIPTION OF USES ask for our free brochure

- ATTENUATION - 45 dB TYPICAL
- BANDWIDTH - 4 MHz AT 5 dB POINTS
- INSERTION LOSS - 2 dB

MODEL	TUNING RANGE	FOR CHANNELS	PASSBAND	PRICE	SHIPPING
23H	50-66 MHz	2,3 (or 6 meter ham)	50-300 MHz	\$30	NO SHIPPING or C.O.D. CHARGES
46FM	66-108 MHz	4,5,6 (or any FM)	50-300 MHz	\$30	
1417	120-144 MHz	14(A) 15(B) 16 (C) 17(D)	50-400 MHz	\$30	
1822	144-174 MHz	18(E) 19(F) 20(G) 21(H) 22 (I)	50-400 MHz	\$30	
713	174-216 MHz	7,8,9,10,11,12,13	50-400 MHz	\$30	

3 for \$75 - 10 for \$200 - mix or match

CALL TOLL FREE FOR C.O.D. OR SEND CHECK TO ORDER
FAST DELIVERY
 30 DAY MONEY BACK GUARANTEE (3 FILTER LIMIT)

Star Circuits

P. O. Box 94917
 Las Vegas, NV 89193-4917

1-800-433-6319

tion, which switches off all outputs when a fault in one output occurs; a user-definable status register for error reporting; and a standby mode that allows voltages and currents to be set up with no power delivered to the load.

U.S. list prices for the PM 2800 power supplies start at \$1595 for the single-output model; \$2895 for the dual-output model, and \$3495 for the triple-output model.—**John Fluke Mfg. Co., Inc.**, P.O. Box 9090, Everett, WA 98206; Tel: 800-44-FLUKE.

REPAIRABLE OSCILLOSCOPE PROBE. The modular construction of *Test Probes, Inc.'s* $\times 1$ - $\times 10$ oscilloscope probe makes it easy to replace a failed tip, ground lead, probe head, cable, or BNC box—the parts simply screw together for quick re-



CIRCLE 22 ON FREE INFORMATION CARD

pairs. The probe features $\times 1$ and $\times 10$ switchable attenuation. Other features include compensation for high and low frequency to optimize pulse response, 250-MHz bandwidth for the $\times 10$ mode, 10-MHz bandwidth for the $\times 1$ mode, and a 1.4-nanosecond rise time. The 10–60-pF compensation range allows use of the probe with any scope that has a 1-megohm input.

The $\times 1$ - $\times 10$ oscilloscope probe costs \$72.00 in single quantity.—**Test Probes, Inc.**, 9178 Brown Deer Road, San Diego, CA 92121; Tel: 800-368-5719.



REALMAGIC!
An ETCHED circuit board from a Printed PAGE in just 3 Hours

The ER-4 PHOTO ETCH KIT gives you the tools, materials and chemicals to make your own printed circuit boards. The patented Pos-Neg™ process copies artwork from magazines like this one without damaging the page. Use the circuit patterns, tapes and drafting film to make your own 1X artwork. Or try the Direct Etch™ system (also included), to make single circuit boards without artwork. The ER-4 is stocked by many electronic parts distributors, or order direct, postpaid.

ER-4 PHOTO ETCH KIT (NJ and CA residents add sales tax) . . . \$38.00
DATAK'S COMPLETE CATALOG lists hundreds of printed circuit products and art patterns. Also contains dry transfer letter sheets and electronic title sets for professional looking control panels. **WRITE FOR IT NOW!**

DATAK Corporation • 55 Freeport Blvd, Unit 23 • Sparks, NV 89431

CIRCLE 189 ON FREE INFORMATION CARD

The Ultimate in Home Control

Heath®



Just imagine, one press of a button and you can turn off your stereo, turn on your TV and VCR, start a videotape, and dim the lights. The best part is you've done it all from your favorite chair.

The One For All remote Whole House Controller, Command Center and Lamp Module make it all possible.

Installation is a snap. The remote Whole House Controller operates virtually any infrared-controlled device, and when used with the Command Center can control lights throughout your house. Just point the remote Whole House Controller at the Command Center and press a button. You've got home control.



See our full line of home automation products and X-10 modules in the HEATH CATALOG. Call 1-800-44-HEATH for your FREE copy.

Order Today
\$119.95*

Use Order Code 601-054 when ordering the One For All System URS-6000.

Call Toll-Free
1-800-253-0570

* Price does not include shipping and handling, or applicable sales tax for MI and CA deliveries



© 1990 Heath Company, Benton Harbor, MI



CL-806R1

CIRCLE 86 ON FREE INFORMATION CARD

Earn Your B.S. Degree in ELECTRONICS or COMPUTERS



By Studying at Home

Grantham College of Engineering, now in our 41st year, is highly experienced in "distance education"—teaching by correspondence—through printed materials, computer materials, fax, and phone.

No commuting to class. Study at your own pace, while continuing on your present job. Learn from easy-to-understand but complete and thorough lesson materials, with additional help from our instructors.

Our Computer B.S. Degree Program includes courses in the BASIC, PASCAL, and C languages — as well as Assembly Language, MS DOS, CADD, and more.

Our Electronics B.S. Degree Program includes courses in Solid-State Circuit Analysis and Design, Control Systems, Robotics, Analog/Digital Communications, and more.

An important part of being prepared to *move up* is holding the right college degree, and the absolutely necessary part is knowing your field. Grantham can help you both ways—to learn more and to earn your degree in the process.

Write or phone for our free catalog. Toll free, 1-800-955-2527, or see mailing address below.

Accredited by
the Accrediting Commission of the
National Home Study Council

GRANTHAM
College of Engineering
Grantham College Road
Slidell, LA 70460

Try the

**Radio
Electronics**

bulletin board
system

(RE-BBS)
516-293-2283

The more you use it the
more useful it becomes.

We support 300 and 1200
baud operation.

Parameters: 8N1 (8 data
bits, no parity, 1 stop bit)
or 7E1 (7 data bits, even
parity, 1 stop bit).

Add yourself to our user
files to increase your
access.

Communicate with other
R-E readers.

Leave your comments on
R-E with the SYSOP.

RE-BBS
516-293-2283

600-WATT LINEAR AMPLIFIER. *Ameritron's AL-811* linear amplifier uses three 811A tubes to deliver 600-watts PEP or 500 watts CW from 160 to 10 meters. (Modification instructions for 10/12-meter operation are available to those who have valid amateur licenses.) The rugged 811A tubes feature a fast (3-second) warm-up time as well as low replacement cost.



CIRCLE 23 ON FREE
INFORMATION CARD

A Pi-network tuned-input circuit matches the tubes to 50-ohm exciters, for good performance even

when the linear amplifier used with fussy solid-state rigs.

Tuning is simplified by the use of a vernier reduction drive on the plate control. Pressurized ventilation is used to keep the tubes and power-supply components at safe operating temperatures.

The *AL-811's* dual illuminated meters provide a complete picture of the important operating conditions. One of the meters gives a continuous reading of grid current; the second meter is switchable so that it can be used to monitor both high-voltage and plate current.

The *AL-811* linear amplifier has a retail price of \$599.00.—**Ameritron**, 116 Willow Road, Star-ville, MS 39759; Tel: 800-647-1800 or 601-323-8211; Fax: 601-323-6551. **R-E**

Cable TV Descrambler Article Parts

We stock the exact Parts, PC Board and Adaptor for several articles published in *Radio-Electronics* magazine on building your own Cable TV Descrambler.

February 1984 SB-3 Type

701 Parts Pkg.....\$19.00
Includes all original parts.

702 PC Board.....7.95
Original 3X4 etched, drilled
and Silk-Screen pc board.

704 AC Adaptor.....7.95
12 to 18 Volt DC @ 200ma.

701, 702 & 704.....29.00
All three for special saving.

February 1987 Tri-Mode

301 Parts Pkg.....29.00
Includes all original parts.

302 PC Board.....7.95
Original 5X8 etched, drilled
and Silk-Screen pc board.

304 AC Adaptor.....7.95
12 to 18 Volt DC @ 200ma.

301, 302 & 304.....39.00
All three for special savings.

Tri-Mode Tutorial..7.95
26 pages of in-depth info.

May 1990 Universal

901 Parts Pkg.....\$49.00
Includes all parts.

902 PC Board.....9.95
Improved 4X7 etched, drilled
and Silk-Screened pc board.

904 AC Adaptor.....8.95
12 Volts AC @ 350ma.

901, 902 & 904.....59.00
All three for special savings.

Snooper Stopper...\$39.00

Prevent Descrambler detection with snooper stopper/data blocker and protect your privacy. Includes free article on Cable Snooping.

Macrovision Kit...\$29.00

Macrovision.....now you see it, now you don't with our macro-scrubber kit. Originally Published in *Radio-Electronics*.

70 Channel Cable TV Converter.....\$89.95

- * 6 Function Infra-Red remote.
- * Fine Tuning.
- * Memory & Recall.
- * Compatible with all External Descrambler.
- * Channel 3 & 4 switchable output.
- * STD, HRC & IRC compatible.

CALL TOLL FREE 1-800-332-3557

Outside USA Call 1-508-699-6935

Visa, MasterCard and COD.
Add \$4.00 S&H, \$6.50 Outside USA.
D & D Electronics, Inc. PO Box 3310, N. Attleboro, Ma. 02761

VISA

MC

CIRCLE 179 ON FREE INFORMATION CARD

CIE Gives You The Training You Need to Succeed... At Your Own Pace...& In Your Own Home!

Discover Your Career Potential In The
Fast-Growing Field Of High-Tech Electronics!

If you're anxious to get ahead...and build a *real* career...you owe it to yourself to find out about the Cleveland Institute of Electronics!

CIE can help you discover your career potential in the fast growing field of high-tech electronics. A career that will challenge and excite you every day...reward you with a powerful feeling of personal accomplishment...and deliver a level of financial security you may have only dreamed of before!

As the leading school in home-study electronics, CIE has helped over 150,000 students in the U.S.A. and over 70 foreign countries get started in this exciting field. To find out how CIE could be helping you...read on...then send for a CIE catalog TODAY!

A Growing Need For Trained Professionals!

The career opportunities shown here are only a few of the challenging, high-paying careers you can enjoy as an electronics technician.

You could be the "brains" behind the scenes of an exciting TV broadcast...trouble-shoot life-saving medical equipment...design exotic new aeronautics systems...CIE's job-oriented programs offer you the quickest possible path to the career of your dreams! And CIE also features military and union re-training, to build on what you already know.

Dozens Of Fascinating Careers To Choose From!

Even if you aren't sure which career is best for you, CIE can get you started with core lessons applicable to *all* areas of electronics. As you advance, CIE makes job opportunities available to you through the bimonthly school paper, *The Electron*.



Data Communications



Automotive Electronics



Avionics



Computer-Assisted Manufacturing



Consumer Electronics



Military Electronics

Personal Training From A Renowned Faculty.

Unlike the impersonal approach of large classroom study, CIE offers you one-on-one instructional help 6 days a week, toll-free. Each CIE lesson is authored by an independent specialist, backed by CIE instructors who work directly with you to answer your questions and provide technical assistance when you need it.

Practical Training... At Your Own Pace.

Through CIE, you can train for your new career while you keep your present job. Each course allows a generous completion time, and there are no limitations on how fast you can study. Should you already have some electronics experience, CIE offers several courses which start at the intermediate level.

"State-Of-The-Art" Facilities & Equipment.

In 1969, CIE pioneered the first electronics laboratory course, and in 1984, the first Microprocessor Laboratory. Today, no other home study school can match CIE's state-of-the-art equipment. And all your laboratory equipment is included in your tuition cost. There is no extra charge—it's yours to use while you study at home and on the job after you complete your course!

Earn Your Degree To Become A Professional In Electronics!

Every CIE course you take earns you credit towards the completion of your Associate in Applied Science Degree, so you can work towards your degree in stages. And CIE is the only school that awards you for fast study, which can save you thousands of dollars in obtaining the same electronics education found in four-year Bachelor's Degree programs!

Send For Your Catalog Today!



CIE World Headquarters

Cleveland Institute of Electronics, Inc.
1776 East 17th St., Cleveland, Ohio 44114

YES! Please send me your independent study catalog (For your convenience, CIE will have a representative contact you—*there is no obligation.*)

Print Name _____

Address _____ Apt # _____

City/State/Zip _____

Age _____ Area Code/Phone No. _____

Check box for G.I. Bill bulletin on educational benefits: Veteran Active Duty

Mail This Coupon Today!

AE05

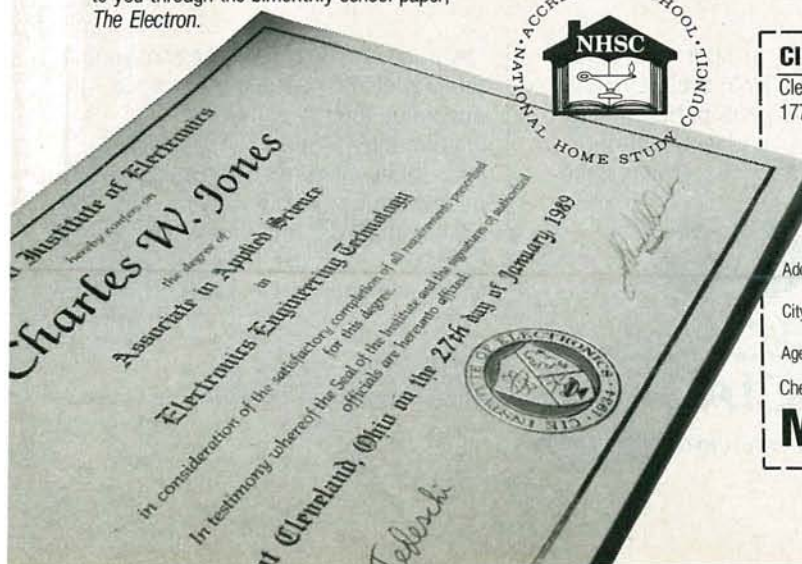

MARCH 1991

\$59.95 INCLUDES 10 GOOD REASONS WHY THIS MULTIMETER IS FOR YOU.



- 1** AUTO RANGING
- 2** FULL OVERLOAD PROTECTION
- 3** DIODE CHECK
- 4** CONTINUITY CHECK WITH ALARM
- 5** 'HANDS-FREE' MEASUREMENT
- 6** CURRENT UP TO 10 AMPS
- 7** MEMORY MODE FOR DEVIATION MEASUREMENT
- 8** 0.5% ACCURACY
- 9** COMPACT RUGGED CONSTRUCTION
- 10** 3 1/2 DIGIT LCD DISPLAY

Global's Model 735 Digital Multimeter provides a superb combination of high performance, low cost and extremely easy operation. Featuring a full complement of Autoranging measurement functions including DC Voltage, AC Voltage, DC Current, AC Current, Resistance, Diode Check, and Continuity check.

Advanced features such as Memory Mode and Data Hold are provided giving the Model 735 performance normally associated with meters costing twice the price. Don't let the

low price and compact size fool you, the Model 735 packs performance and value found in all Global instruments. Clearly, the Model 735 is the best value available in it's price category, and is suitable for school, hobbyist and professional users.

Order yours today!!

\$59.95!

A024



Call toll-free for details
1-800-572-1028



**GLOBAL[®]
SPECIALTIES**

Global Specialties
70 Fulton Terrace, New Haven, CT 06512
Telephone: (203) 624-3103. ©Interplex Electronics, 1990.

CIRCLE 178 ON FREE INFORMATION CARD

Build this video telephone

Build a two-way videophone and send and receive video pictures over standard phone lines to and from anywhere in the world!

CHARLES COLBY

EVER SINCE IT WAS DEMONSTRATED at the 1939 World's Fair, the picture phone was something placed at the top of many people's wish list. Unfortunately it remained out of reach of the average person—even those who could afford the expense often could not afford the physical space required for such a system. However, videophones were recently made available to consumers at affordable prices, thanks to a new IC that greatly reduces the cost and size of a videophone system. And, even though it was possible to build a videophone before the advent of this new chip (see **Radio-Electronics**, August 1982), it's never been easier than now.

This article presents a videophone, or videomodem, that transmits and receives still video frames over the phone line, in high-resolution (200×242 pixel) video with a six-bit (50-level) gray scale. It provides a substantially better picture than the low-resolution 96×96 pixel units with limited gray scale that you may have seen.

The project basically consists of the videophone base unit; you

can buy it as a bare board in kit form or as an assembled and tested unit. Among other components, the board contains one IC that does all of the dirty work. The base unit is connected to a small CCD camera module and Sony *Watchman*. However, the unit uses standard monochrome NTSC-type 1-volt p-p video for the input and output, so if you already have a standard video camera (or camcorder) and monitor, you can use them and save money.

To send or receive a video image, you do, of course, need two

complete units, or at least know somebody else who is building one. When you order the PC board from Colby Systems, you will receive a list of users that have Colby videophone units. That will give you contacts to help get your unit up and running and people who you can exchange pictures with. If you would like to have your name and phone number included on this

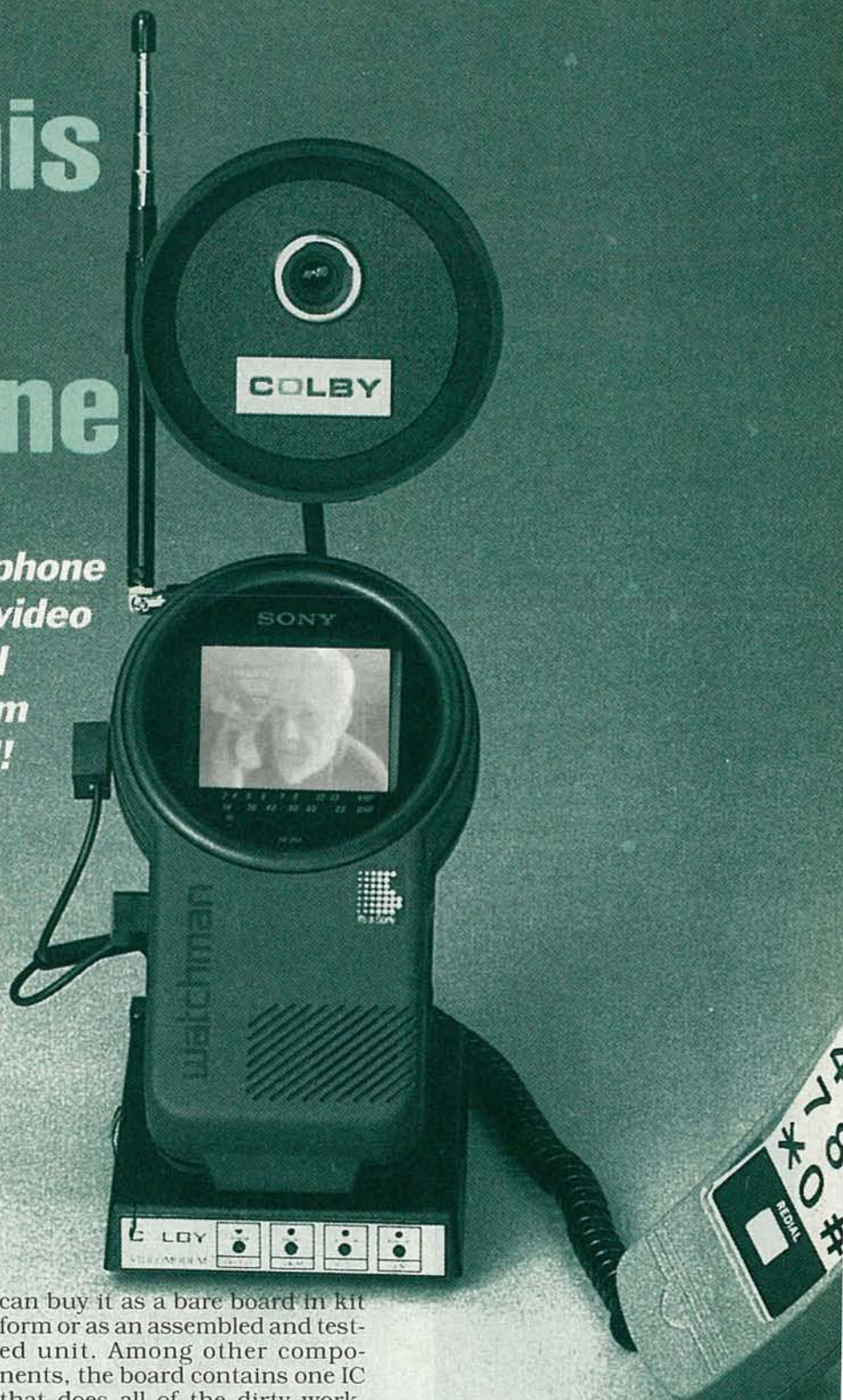

list, please let Colby Systems know about it.

Uses

The videophone has many potential uses other than simply showing off the kids to the grandparents. Such uses might be a commercial artist and page layout person collaborating on a catalog page layout, or perhaps a construction foreman showing a detail on location to an architect in his office half way around the world.

An automatic mode makes another interesting application possible: the videophone can be used to remotely monitor your house or business, or perhaps a volume gauge on an oil pumping station. By setting up a video camera to view an area, the videophone's automatic mode could be used to send a new video frame every 38 seconds over an ordinary phone line.

However, that scheme would work only if you had called another videophone and left the phone off the hook while you were away. That would be expen-



FIG. 1—THE VIDEOPHONE CONSISTS OF THREE SECTIONS: the CCD camera module at the top, the video monitor, and the base unit that contains the videophone circuitry.

sive to have a phone line in use 24 hours a day—but for certain monitoring situations, the cost

All resistors are 1/4-watt, 5%, unless otherwise noted.

- R1—510 ohms (×4) 8-pin SIP
- R2—390 ohms (×5) 10-pin SIP
- R3—10,000 ohms (×4) 8-pin SIP
- R4—4700 ohms (×5) 10-pin SIP
- R5—1000 ohms (×7) 8-pin SIP, pin 1 common
- R6—1000 ohms (×5) 10-pin SIP
- R7—1000 ohms (×3) 6-pin SIP
- R8—110,000 ohms (×3) 6-pin SIP
- R9—680 ohms
- R10, R19—6800 ohms
- R11—27 ohms
- R12—2000 ohms
- R13—3900 ohms
- R14—8200 ohms
- R15—15,000 ohms
- R16—27,000 ohms
- R17—4700 ohms
- R18—180 ohms
- R20—75 ohms

Capacitors

- C1, C4, C5, C15, C17, C20—470 μ F, 16 volts, radial electrolytic
- C2, C3, C9, C18—100 μ F, 16 volts, radial electrolytic
- C6, C10, C24—10 μ F, 35 volts, radial electrolytic
- C7, C12, C13, C14, C21, C22, C23—0.1 μ F, monolithic
- C8—0.1 μ F, 200 volts, polyester
- C11—0.05 μ F, ceramic
- C16—not used
- C19—4.7 μ F, radial electrolytic

Semiconductors

- IC1, IC2—7805 5-volt regulator
- IC3—MP7682 A-to-D converter
- IC4—LM324 quad op-amp
- IC5, IC6—MB81464-12 64K×4 DRAM
- IC7—PMC-VP video controller
- IC8—GAL16V8 custom A-to-D filter
- IC9—LM393 low-power voltage comparator
- DN1—1N914 (×8) diode network (contains D1, D3, D9—D13, D16)
- D2, D4, D5—1N4001 diode
- D6—D8, D14, D15—not used
- LED1—LED4—miniature red light-emitting diode

- Q1, Q2, Q5—2N2222 NPN transistor
- Q3, Q4—2N3906 PNP transistor

Other components

- FB1—FB9—ferrite bead over jumper wire
- J1—coaxial power jack
- J2, J6—RCA jack
- J3—miniature phone jack
- J4, J5—modular phone jack
- J7—subminiature phone jack
- J8, J9—3-pin header jumper block
- T1—600/600 ohm audio isolation transformer, 1500 volt rating
- XTAL1—3.57 MHz crystal
- S1—SPST switch
- S2—S5—momentary pushbutton
- RY1—SPST relay, 12-volt coil

Miscellaneous: four 3/8-inch LED stand-offs, PC board, 120 VAC to 12 VDC adapter, three 18-pin IC sockets, one

14-pin IC socket, one 20-pin IC socket, one 48-pin IC socket, one 8-pin IC socket, one 16-pin IC socket, jumper wire, project case, video camera, video monitor, coaxial interconnecting leads (for power and video between base unit and monitor and camera), solder, etc.

Note: The following items are available from Colby Systems Corporation, 2991 Alexis Drive, Palo Alto, California, 94304 (415) 941-9090, Fax (415) 949-1019. Send check or US postal money order. Checks take 2–3 weeks to clear. California residents add 7.25% sales tax. All prices FOB Palo Alto or Clovis, California. Shipping charges are UPS ground, continental US only, and insurance is included. Add \$5.00 handling fee to each order.

- Bare PC board (PCB-VP)—\$24.99 + \$3.50 S&H
 - PMC-VP video controller IC (PMC-U7)—\$49.99 + \$3.50 S&H
 - Kit of all other IC's including pre-programmed IC8 (Kit IC-8)—\$39.99 + \$3.50 S&H
 - Kit of all discrete components (resistors, capacitors, diodes, transistors, crystal, transformer, jacks, switches, LED's, relay) (kit-VPC)—\$49.99 + \$3.50 S&H
 - AC adapter (VP-AC)—\$12.99 + \$4.50 S&H
 - Kit of all of the above parts (everything to build one complete videophone base unit, except case) (Kit-unit)—\$169.99 + \$7.50 S&H
 - 240×320 line CCD camera module (XP-CCD-1)—\$299.99 + \$5.50 S&H
 - Sony 2.7-inch monitor (Sony-2)—\$129.99 + \$4.50 S&H
 - Videophone-to-monitor power & video cable (PVC-M)—\$9.95 + \$3.50 S&H
 - Videophone-to-camera power & video cable (PVC-C)—\$9.95 + \$3.50 S&H
 - All of the above items ordered at one time (Kit-complete)—\$599.99 + \$13.25 S&H
 - A VHS video tape showing step-by-step assembly and testing, including sample pictures—\$19.95 + \$4.75 S&H
 - An assembled and tested version of the videophone will be available as soon as FCC testing and registration are completed. Write Colby Systems for price list.
- The following items are available from Gettys Electronics, 22018 Frontier Road, Clovis, CA 93612 (209) 299-7828.
- Round video camera case (Cam-case-1)—\$29.99 + \$5.50 S&H
 - Videophone case with metal bottom and plastic top (VP-case-1)—\$34.99 + \$5.50 S&H.

might be acceptable. For in-house lines, it might be a convenient way to remotely monitor

something without running new wires.

Another way to do monitoring

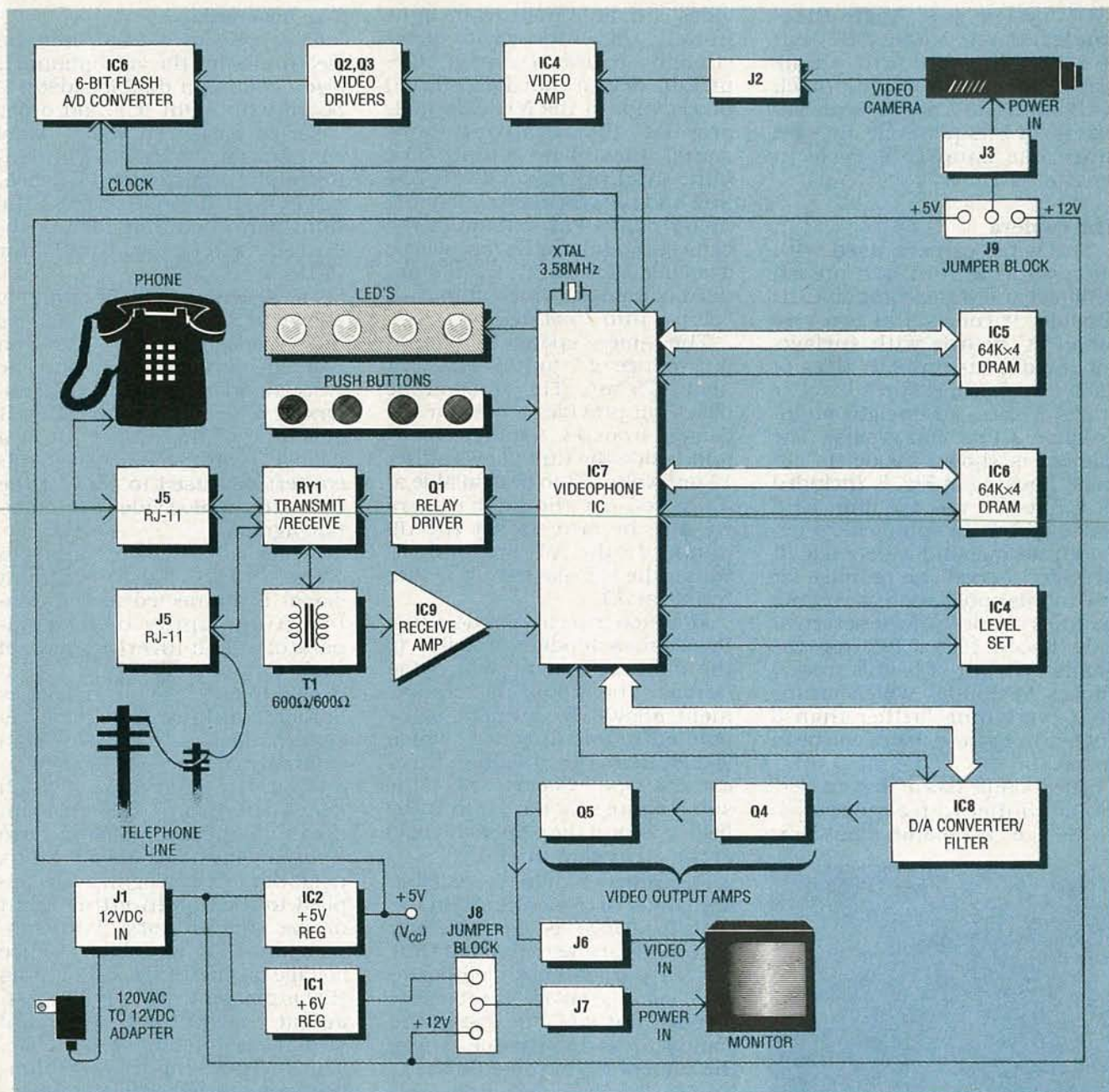

FIG. 2—VIDEO IS FED INTO J2; it is then amplified, digitized, and converted to a series of audio tones to be sent over standard telephone lines.

is to connect the output of the videophone in parallel with a phone answering machine with no message—or perhaps a short message to tell you which monitoring station you have reached. After the outgoing message, record 2 or 3 minutes of silence. (You must use the older type of machine that lets you control the end of the outgoing message.) Then you will be able to use the answering machine for both the announcement function and the off-hook timer, to allow the videophone to output one or more frames of video.

Overview

As shown in Fig. 1, the videophone consists of three main sections: the CCD camera module at the top, the video monitor, and the base unit that contains the videophone circuitry. Because the camera module is mounted on the TV's antenna, and because the antenna isn't needed when feeding the monitor with a direct video input, the camera can be easily pointed in any direction.

Take a look at the block diagram in Fig. 2. The video output of any standard video camera, camcorder, VCR, videodisc, etc.,

is fed into J2; it is then amplified, digitized, and converted to a series of audio tones in the range of 1700 to 3500 Hz. That frequency range is low enough to be sent over standard telephone lines, recorded on a low-cost audio cassette tape, or transmitted between two-way radios.

It takes 9 to 12 seconds to send or receive a still video picture, during which time both phones are silenced. The data being sent are pulse-width modulated with data rates of about 32 kilobits per second. The data transmission rate is about half that of the new

ISDN system (see **Radio-Electronics**, May and June 1989), but it works on standard phone lines. Each baud is one pixel, with up to 6 bits of gray scale per baud—12 bits per cycle are sent since one baud is $\frac{1}{2}$ cycle in length.

The camera

The video camera used with the prototype unit is a pre-assembled and tested Chinon CCD module; it consists of two very small PC boards with surface-mounted parts on both sides of each board; it measures $1 \times 1\frac{3}{16} \times 2\frac{3}{4}$ inches, and weighs an incredible 2.1 oz. (60 grams). The camera is shown inside its circular housing in Fig. 3. Included is a fixed-focus, 4.5 mm, F1.8 lens, which is somewhere between normal and wide angle. It provides a good compromise for use in this application; a person's face fills about $\frac{2}{3}$ of the screen at a distance of $1\frac{1}{2}$ to 2 feet from the camera. Depth of field is from 6 inches to infinity, which means that everything farther than 6 inches from the camera will be in focus.

The module has a built-in electronic shutter with a range of $\frac{1}{60}$ to $\frac{1}{15,000}$ of a second. That pro-

vides a usable picture in light from 2 LUX all the way to direct sunlight. It uses a $\frac{1}{3}$ -inch MOS pickup device that has 80,000 pixels and, in the NTSC format, provides 240 vertical by 230 horizontal lines of resolution. The horizontal frequency is 15.734 kHz and the vertical frequency is 59.94 Hz. (A PAL version of the camera module for Europe will be available.) The output is a standard composite video signal—1 volt p-p into 75 ohms.

The camera operates on an input voltage of 7 to 12 volts DC at about 75 mA. The videophone base unit provides power for the camera from J3. A jumper block (J9) inside the unit allows either 12 or 5 volts DC to be available at J3. If you use the same camera we did, be sure to set the J9 jumper to the A-B position (12 volts); the B-C position provides 5 volts at J3.

Mounted in a circular housing, the camera module attaches to the monitor's antenna with nylon clamps. The mounting arrangement allows the camera to be pointed in any direction, which is a lot more versatile than fixed-camera type systems where the subject must be moved into the field of view of the camera instead of the other way around.

The camera module is available from the source mentioned in the parts list. However, if you already have a video camera that puts out a 1-volt p-p standard composite video signal, you are free to use it instead, but you'll be losing the compactness and ease of aiming the camera when you do that.

The TV/monitor module

The TV monitor we used is an un-modified, off-the-shelf, Sony black-and-white *Watchman* TV (model FD-250). The unit has a composite-video input jack so it can directly accept the video from the videophone base unit. The picture is surprisingly sharp and clear, but that partially depends on the quality of the camera you use.

The monitor attaches to the top of the base unit with a bracket and a strip of velcro. The bracket attaches to the monitor's rear support foot. The monitor is available from the source mentioned in the parts list and, more than likely, at a store near you.

The base unit

The base unit contains the electronics for the videophone. It also contains a double-sided PC board with eight IC's and other assorted parts. The back panel contains an on/off switch and input and output jacks for video, power, and the phone line. The front panel contains four push-button switches and indicator LED's.

The schematic for the circuit is shown in Fig. 4; let's first discuss how a video image is sent from one videophone to another. The video signal from the camera enters J2 where it is coupled by C1 and R4-c to the input of IC3, a flash A/D converter. The flash A/D converter is used to convert the incoming analog video into a digital signal.

A block diagram of the flash A/D is shown in Fig. 5. The input signal is connected to the non-inverting inputs of 64 comparators. The inverting side of each input comparator is connected to one resistor in a series ladder configuration. The resistor ladder is connected to an external reference-voltage generator (IC4, Q3, and Q2), which keeps the input of each comparator in the chain referenced to a slightly higher voltage than its neighbor. An analog input is applied to the non-inverting input of the comparators. The comparators that have a reference voltage on their inverting inputs that is greater than the video voltage at that point in time will switch to a different output state. The outputs of the 64 comparators are fed into the 64 inputs of the latches which are enabled by every clock pulse at a rate of 3.58 MHz.

At this point the input signal has been converted a group of 64 on-off conditions. The 64 on-off levels are then encoded into a 6-bit byte which is output through a flip-flop and three-state buffer for each of the six bits. An analog input of 0 volts produces an output code of 0. An analog input of 1.5 volts produces an output code of 100,000 (with a V_{REF} of 3.2 volts).

The 6-bit digital output code of a number between 0 and 100,000 representing a video input level between 0 and 1.5 volts is then fed into pins 27–32 of IC7, the

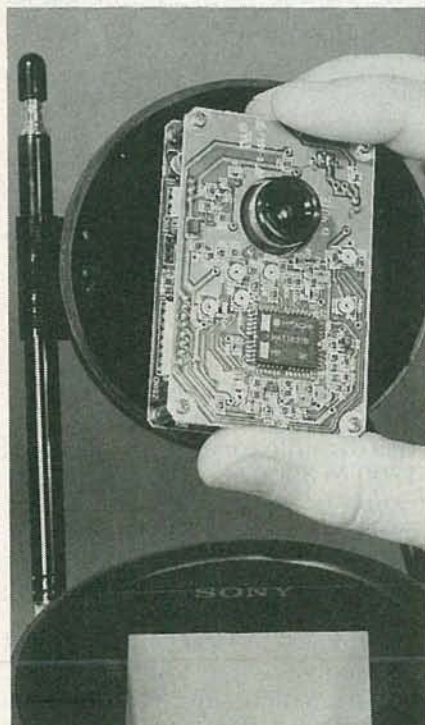

FIG. 3—THE CAMERA IS FIXED-FOCUS, with a 4.5 mm, F1.8 lens. The pre-assembled and tested unit consists of two very small PC boards with surface mounted parts, and weighs only 2.1 oz.

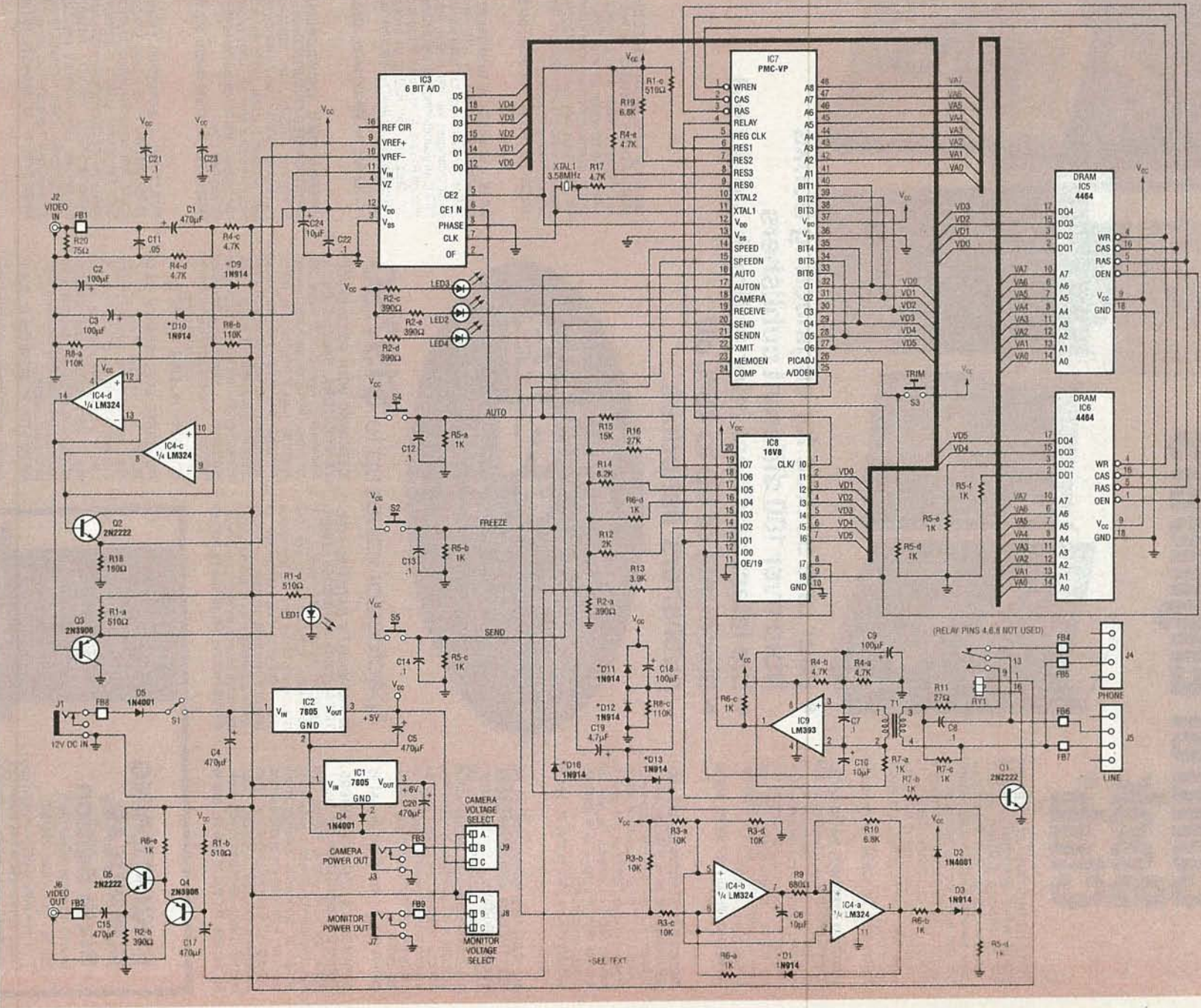

FIG. 4—SCHEMATIC FOR THE VIDEOPHONE CIRCUIT. The video signal enters J2 where it is coupled by C1 and R4-c to the input of IC3, a flash A/D converter.

videophone controller chip. Inside this 48-pin IC, the digital input is converted to a series of

audio tones in the 1200- to 3450-Hz range and fed out of pin 23 to the primary of transformer T1,

which isolates and couples the signal to the telephone line through relay RY1 and RJ-11 jack.

Join the Electronics and Control Engineers' Book Club®

TROUBLESHOOTING ELECTRONIC EQUIPMENT WITHOUT SERVICE DATA, Second Edition. By R.G. Middleton. 320 pp., illus. This indispensable new edition features all the information that made the first edition so successful, plus the latest developments in digital testing, phase checks, IC troubleshooting, and repair of VCRs, stereos, TVs, tape recorders, and much, much more.
585092-3 Pub. Pr., \$30.00 Club Pr., \$22.50

PRINTED CIRCUITS HANDBOOK, Third Edition. By C.F. Coombs, Jr. 960 pp., 556 illus. Here in one handy volume is all the information you need to design, manufacture, test, and repair printed wiring boards and assemblies. This new edition features ten all-new chapters, including three on SMT.
126/097 Pub. Pr., \$64.95 Club Pr., \$45.50

PRACTICAL ELECTRICAL WIRING, Fifteenth Ed. By H. P. Richter & W. C. Schwan. 672 pp., illus. The latest edition of the classic guide to electrical wiring. Updated to cover 1990 Code, this comprehensive reference explains the how and why of each operation—all without advanced mathematics.
523/932 Pub. Pr., \$32.95 Club Pr., \$24.95

MCGRAW-HILL ENCYCLOPEDIA OF ELECTRONICS AND COMPUTERS, Second Edition. S. Parker, Editor-in-Chief. 1,047 pp., 1,250 illus. Featuring 160 new and revised articles, this new edition treats the entire spectrum of applications, devices, systems, and theory in areas ranging from the flow of electricity to hardware, software, robotics, and IC fabrication.
454/99X Pub. Pr., \$79.50 Club Pr., \$54.95

COMMUNICATIONS RECEIVERS: Principles and Design. By Ulrich L. Rohde and T.T.N. Bucher. 608 pp., 402 illus. Everything you need to know if you design or work with communications receivers, from theory to practical design approaches. Coverage includes all types of receivers: shortwave, broadcast, radar, military, marine, aeronautical, and more.
535/701 Pub. Pr., \$64.95 Club Pr., \$44.50

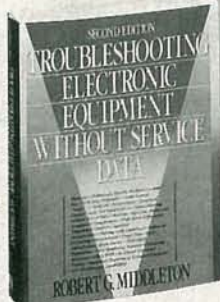

- your one source for engineering books from over 100 different publishers
- the latest and best information in your field
- discounts of up to 40% off publishers' list prices

New Members!
Take any one of these great professional books for only **\$289** as a premium with your first selection!

Spectacular values up to **\$197.90**

MOBILE CELLULAR TELECOMMUNICATIONS SYSTEMS. By W.C.Y. Lee. 442 pp., 215 illus. A to Z coverage of state-of-the-art cellular systems, from design to implementation and troubleshooting. Clearly explains spectrum efficiency, propagation models and prediction, interference treatment, and more.
370/303 Pub. Pr., \$62.95 Club Pr., \$44.50

EASY AutoCAD: A Tutorial Approach, Second Ed. By J. D. Hood. 296 pp., illus. Now you can teach yourself all the techniques you need to apply AutoCAD to all your drafting projects. Updated through Release 10, this best-selling tutorial takes you from booting up through three-dimensional drafting and advanced topics.
297/509 Pub. Pr., \$39.95 Club Pr., \$27.50

INTERNATIONAL ENCYCLOPEDIA OF INTEGRATED CIRCUITS. Edited by S. Gibilisco. 1,063 pp., illus. Instant access to over 1,000 ICs from the world over, with complete practical details on each circuit, including what it is, what it does, how it does it, and its relationship to other ICs and their uses.
585263-2 Pub. Pr., \$75.00 Club Pr., \$52.50

MCGRAW-HILL'S NATIONAL ELECTRICAL CODE HANDBOOK, Twentieth Ed. By J. F. McPartland & B. J. McPartland. 1,264 pp., 1,150 illus. The latest edition of this definitive sourcebook clearly and completely incorporates all new and reworked sections, including special requirements for conductor capacity, branch circuits, grounding, and more.
458/146 Pub. Pr., \$49.50 Club Pr., \$37.50

DESIGNING WITH FIELD-EFFECT TRANSISTORS, Second Ed. By Siliconix Inc., Revised by E. Oxner. 320 pp., illus. This on-the-job guide provides page after page of practical data, tables, examples, and design and specification strategies to help you capitalize on recent breakthroughs in MOSFET design. Coverage includes FET operating principles and procedures . . . step-by-step fabrication methods . . . how to bias FETs for desired performance . . . and much more.
575/371 Pub. Pr., \$39.95 Club Pr., \$29.95

PORTABLE ELECTRONICS DATA BOOK. By J. Douglas-Young. 360 pp., illus., softcover. A-to-Z coverage of all the essential facts, figures, and formulas you need in a format that's easy to use and easy to carry. Includes equations, algorithms, and BASIC programs in areas ranging from alternating current to waveguides and cavities.
585390-6 Pub. Pr., \$33.00 Club Pr., \$24.95

PRACTICAL ELECTRONIC TROUBLESHOOTING. By J. D. Lenk. 394 pp., illus. A clear, no-nonsense guide to identifying and correcting faults in industrial machinery, military equipment, and consumer products. Includes valuable pointers on using manuals and data sheets, localizing the problem, breakdowns in more than one circuit, and more.
585439-2 Pub. Pr., \$37.00 Club Pr., \$28.95

CABLE TELEVISION TECHNOLOGY AND OPERATIONS: HDTV and NTSC Systems. By E. R. Bartlett. 400 pp., illus. From practical troubleshooting to large-scale system upgrades, get step-by-step guidance on the design, manufacture, and maintenance of today's cable TV systems.
039/577 Pub. Pr., \$49.50 Club Pr., \$37.50

SURFACE-MOUNT TECHNOLOGY FOR PC BOARD DESIGN. By J.K. Holomon, Jr. 504 pp., illus., softcover. Get a real working understanding of SMT. This up-to-date guide provides a proven, step-by-step approach to SMT design as it thoroughly covers components, methods, and techniques for maximizing quality, reliability, and profitability.
585235-7 Pub. Pr., \$49.95 Club Pr., \$36.50

ENGINEERING FORMULAS, Sixth Edition
By Kurt Gieck and Reiner Gieck
568 pp., 4 x 6, illus., 234/558

This new edition of the classic engineers' pocket guide has been fully updated to include new material on differential equations, integral and vector calculus, electrical engineering, and more. Logically arranged and just the right size, **ENGINEERING FORMULAS** is better than ever . . . and it's yours **ABSOLUTELY FREE!**

Kurt Gieck
Reiner Gieck
Engineering Formulas
6th Edition

A \$25.95 Value—Yours ABSOLUTELY FREE when you join!

INDUSTRIAL ELECTRONICS, Third Ed. By J.T. Humphries and L.P. Sheets. 651 pp., illus. A clear, convenient guide to the components and systems used in modern industry. Included is an extensive collection of manufacturers' data sheets, along with many quick-access tables and charts. 585226-8 Pub. Pr., \$41.95 Club Pr., \$31.95

MORE C TOOLS FOR SCIENTISTS AND ENGINEERS. By L. Baker. 308 pp., illus. Now you can apply the C programming language to problems in statistics, graphics, mathematics, linear systems, and more. Coverage includes sparse systems, multivariate statistics, contour plotting, sorting . . . all presented in state-of-the-art algorithms. 033/587 Pub. Pr., \$29.95 Club Pr., \$22.95

DIGITAL FILTERS AND SIGNAL PROCESSING, Second Ed. By L.B. Jackson. 410 pp., illus. An acclaimed guide to signal processing theory, design methods, and implementation strategies. Using an intuitive approach, the author covers state-space representation, A/D and D/A conversion, the DFT, FFT, and much more. 585269-1 Pub. Pr., \$52.50 Club Pr. \$39.50

SWITCHGEAR AND CONTROL HANDBOOK, Second Ed. Edited by R. W. Smeaton. 1,056 pp., 789 illus. The only handbook that treats all aspects of switchgear control, including design, applications, safety, and maintenance. Updated to reflect the changes brought about by the use of computers, solid-state devices, and programmable controls. 584/494 Pub. Pr., \$85.00 Club Pr., \$59.95

ANTENNA APPLICATIONS REFERENCE GUIDE. Edited by R. C. Johnson and H. Jasik. 496 pp., 368 illus. and tables. Covers the major applications of antenna technology in all areas of communications and their design methods. Emphasizes important new applications such as earth station, satellite, seeker, aircraft, and microwave-relay antennas. 322/848 Pub. Pr., \$59.95 Club Pr., \$42.50

C: The Complete Reference, Second Ed. By H. Schildt. 823 pp., illus., softcover. This acclaimed reference is now updated to include the ANSI C standard and all new material on C++ programming. Now you'll have the answer to virtually any question on C at your fingertips. 881538-X Pub. Pr., \$28.95 Club Pr., \$21.95

AUDIO ENGINEERING HANDBOOK. Edited by K. B. Benson. 1056 pp., 722 illus. The ideal on-the-job reference for professionals who design, operate, and service audio equipment. It's a one-volume source of fundamental audio acoustics engineering information and practical how-to source book covering generation, transmission, storage, and reproduction of the audio signal. 047/774 Pub. Pr., \$86.95 Club Pr., \$59.95

Be sure to consider these important titles as well!

ASSEMBLY LANGUAGE PROGRAMMING FOR THE 80386. By J. N. Fernandez and R. Ashley. 205/752 Pub. Pr., \$24.95 Club Pr., \$18.95

LENK'S VIDEO HANDBOOK: Operation and Troubleshooting. By J. D. Lenk. 372/918 Pub. Pr., \$39.95 Club Pr., \$29.95

ESSENTIAL CIRCUITS REFERENCE GUIDE. By J. Markus & C. Weston. 404/623 Pub. Pr., \$59.95 Club Pr., \$47.50

THE PROGRAMMABLE LOGIC DEVICE HANDBOOK. By V. L. Burton. 585568-2 Pub. Pr., \$49.95 Club Pr., \$34.95

ENGINEERING FUNDAMENTALS FOR THE PROFESSIONAL ENGINEERS' EXAM, Third Ed. By L.M. Polentz. 503/931 Pub. Pr., \$39.50 Club Pr., \$27.95

DIGITAL BUS HANDBOOK. Edited by J. DiGiacomo. 169/233 Pub. Pr., \$64.50 Club Pr., \$48.50

COMPLETE GUIDE TO ACTIVE FILTER DESIGN, OP AMPS, AND PASSIVE COMPONENTS. By Z. H. Meiksin. 585454-6 Pub. Pr., \$35.00 Club Pr., \$27.50

PRINTED CIRCUITS DESIGN: Featuring Computer-Aided Technologies. By G. L. Ginsberg. 233/098 Pub. Pr., \$39.95 Club Pr., \$29.95

DIGITAL AND MICROPROCESSOR TECHNOLOGY, Second Ed. By P. J. O'Connor. 585184-9 Pub. Pr., \$42.00 Club Pr., \$33.50

ELECTROSTATIC DISCHARGE CONTROL: Principles and Practice. By O. J. McAteer. 448/388 Pub. Pr., \$59.50 Club Pr., \$44.50



Here's how the Club works to serve YOU:

- **IMPORTANT INFORMATION... WE MAKE IT EASY TO GET!**
In our rapidly changing world, those who perform best are those who are best informed. Designed exclusively for the practicing engineer, the Electronics and Control Engineers' Book Club provides you with information that is relevant, reliable, and specific enough to meet your needs. Each Club bulletin comes your way 14-16 times a year and offers you more than 30 books to choose from — the best and newest books from all publishers!
- **DEPENDABLE SERVICE... WE'RE HERE TO HELP!**
Whether you want information about a book or have a question about your membership, our qualified staff is here to help. Just call us toll-free or write to our Customer Service. We also make sure you get only the books you want. All you do is simply tell us your choice on the Reply Card and return it to us by the specified date. If you want the Main Selection, do nothing — it will be sent to you automatically. (A small shipping and handling charge is added to each shipment.)
- **CLUB CONVENIENCE... WE DO THE WORK!**
Beyond the benefit of timely information, Club membership offers many other benefits. For example, you get a wide choice of books that cannot be matched by any bookstore — anywhere. And all your books are conveniently delivered right to your door. You also get the luxury of 10 full days to decide whether you want the Main Selection. If you should ever receive a Main Selection you don't want because the Club bulletin came late, just return it for credit at our expense.
- **SUBSTANTIAL SAVINGS... AND A BONUS PROGRAM TOO!**
In keeping with our goal to provide you with the best information at the greatest possible savings, you will enjoy substantial discounts — up to 40%! — on every book you buy. Plus, you're automatically eligible for our Bonus Book Plan which allows you savings up to 70% on a wide selection of books.
- **EASY MEMBERSHIP TERMS... IT'S WORTHWHILE TO BELONG!**
Your only obligation is to purchase one more book — at a handsome discount — during the next 12 months, after which you enjoy the benefits of membership with no further obligation. Either you or the Club may cancel membership anytime thereafter.

MAIL THIS COUPON TODAY

McGraw-Hill Book Clubs
Electronics and Control Engineers'
Book Club®
 P.O. Box 582, Hightstown, NJ 08520-9959

Please enroll me as a member and send me the two books indicated, plus ENGINEERING FORMULAS, 6/e. I am to receive one book for just \$2.89, the other at the discounted member's price, plus local tax, shipping and handling charges. I agree to purchase a minimum of one additional book during my first year of membership as outlined under the Club plan described in this ad. I understand that a shipping and handling charge is added to all shipments.

Your FREE Book

234/558

Write Code No. of the \$2.89 selection here Write Code No. for the First selection here

Signature _____

Name _____

Address/Apt. # _____

City _____

State _____ Zip _____

This order subject to acceptance by McGraw-Hill. All prices subject to change without notice. Offer good only to new members. Foreign member acceptance subject to special conditions.

ECGA-044

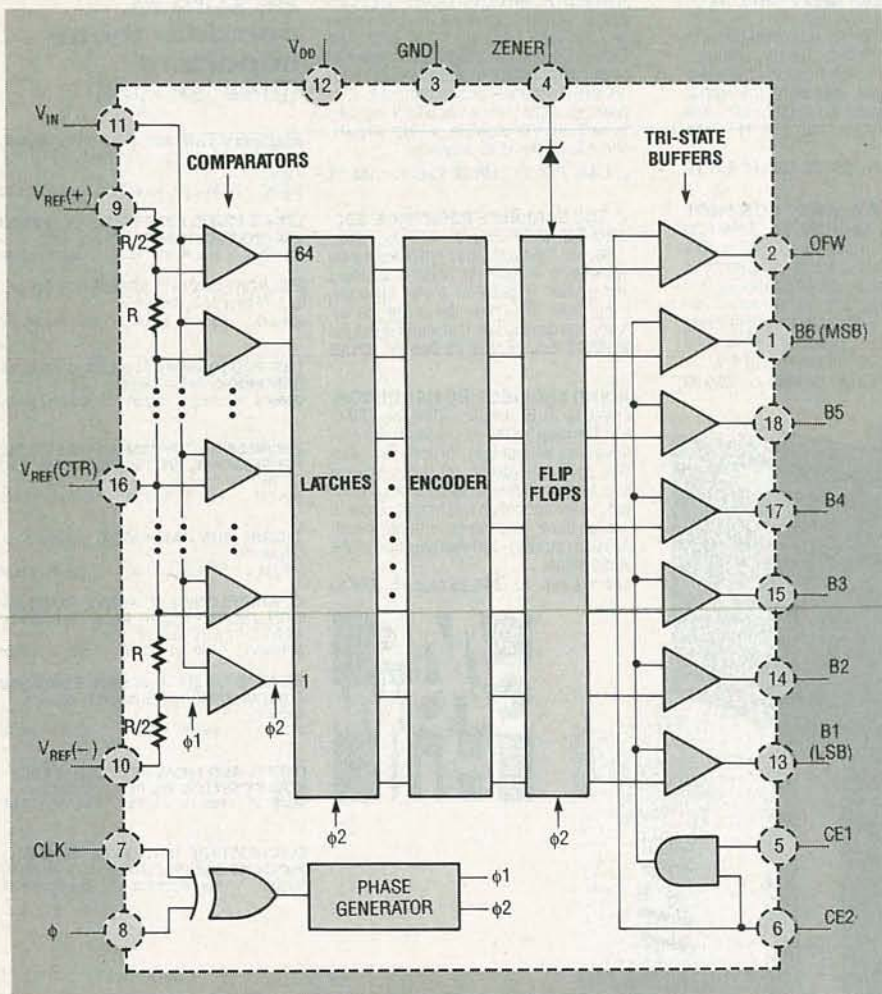

FIG. 5—THE FLASH A/D CONVERTER is used to convert the incoming analog video signal into a digital signal. The input signal is connected to the non-inverting inputs of 64 comparators.

J5. At the start of a transmission, there is a short 3442-Hz tone burst that triggers the receiving videophone to go into the receive mode.

Receiving an image

When a 3442-Hz tone is present at pin 24 of IC7, it automatically switches the system into the receive mode. The tones coming from the phone line at J5 (representing video information) are coupled by C8 to T1. The secondary of T1 is connected to the differential inputs of IC9, an LM393 op-amp, which amplifies the audio tones and presents them to pin 24 of IC7.

The video controller chip (IC7) then converts the audio tones into 6-bit digital words and stores the video frame in digital form in DRAM's IC5 and IC6. The digital data is then output to IC8, a proprietary Colby programmable logic array (PAL), which func-

tions as a D/A converter and filter. The PAL converts the digital signal back into composite video which is further amplified by Q4 and Q5 and then coupled by C15 to the video output jack, J6. The video format is standard NTSC (or PAL on special order), so it can be fed into any video tape recorder or video monitor.

The audio tones containing the video information (available at J5) can also be recorded on an ordinary audio cassette if desired. If you do that, you must attenuate the signal out of J5 if you want to run it into the recorder's microphone input. For playback, the signal out of the recorder must be within the videophone's input range of 250 mV to 5 volts p-p.

Power distribution

A 120 volt AC to 12 volt DC, 1-amp AC adapter (a 220-volt version is also available) provides

power for the videophone, and it is input at J1. The voltage passes through D1, a polarity protecting diode, to S1, the main power switch. From there, the 12 volts is applied to 7805 voltage regulators IC1 and IC2; IC2 supplies +5 volts to most of the circuitry, and IC1 puts out 5.7 volts because of D4 in its ground return path. Jumper blocks J8 and J9 are used to select the output voltage to power the camera and monitor.

If you use the Sony monitor, place jumper on J8 in the B-C position. That will supply 5.7 volts DC at J7; if you use a 12-volt monitor, place the jumper in the A-B position. Maximum current out of J7 is 450 mA at 5.7 volts or 650 mA at 12 volts. (That also depends on how much power you are drawing out of J3 for the camera power.)

If you use the CCD camera module mentioned in this article, set the jumper on J9 to the A-B position to provide +12 V to J3 for the camera (the B-C position provides 5 volts to J3). If you use different cameras or monitors, be careful to observe the power ratings of both the AC adapter (which is rated 12V at 1 amp, or 12 watts), IC1 and IC2 which, without a heatsink should not put out more than 55 mA each. The videophone base unit requires 12 volts at 150 mA, or 1.8 watts; the CCD camera requires 12 volts at 75 mA, or 0.9 watts; and the Sony monitor requires 6 volts at about 380 mA, or 2.3 watts; the three units total about 5 watts. Other camera/monitor combinations may require the use of separate AC adapters to supply power to them. Of course, when you use separate adapters, you would then lose the ability to turn all three units on and off with the one power switch on the rear of the videophone.

Next month

That's all we have room for this month. In the meantime, we have provided the list of parts you'll need, as well as places to get them. You might want to obtain everything you need right now, so that next month you'll be able to complete this project. We'll be going over all of the construction details, as well as the hookup and operation of the unit. R-E

TURN YOUR PC INTO A UNIVERSAL FREQUENCY COUNTER

***Build a frequency-counter board
that operates in a Windows
environment in your personal computer.***

JOEY GRASTY and BILL SCHULZ

LAST MONTH WE STARTED TALKING about the PC10's circuitry. So let's pick up where we left off. The pin description and equations for the PAL (IC4), mentioned last month, is shown in Listing 1.

Shown in Fig. 3 are two 74HCT374 eight-bit registers (IC9 and IC10) that control operation of the PC10. The registers are of the write-only type; they may not be read back. Register 1 (REG1) controls the source selection for inputs A and B of the OE10 and the prescale used for frequency measurements. Register 2 (REG2) selects the input source for the pulse-width measurement, the pulse-width polarity, and hysteresis and gain levels for the input amplifiers. See the PC10 register map (Table 2) for more details.

Input signals to the A and B inputs on the OE10 are selected using 74AC11151 eight-to-one multiplexers (IC16–IC18). The input-A multiplexer, IC16, controlled by ASEL2–ASEL0 in register 1, determines which input signal drives input A. The output of the multiplexer drives one input of relay RY3, which selects either the multiplexer out-

put or the output of the 50-ohm amplifier. That circuit is required because the 50-ohm amplifier generates signals that are higher in frequency than the multiplexer can pass. Relay RY3 is also controlled by ANSEL2–ANSEL0, decoded by IC23-a, the 74ALS12 NAND gate, which in turn drives Q3. Similarly, BSEL2–BSEL0 control which input signal drives input B with multiplexer IC17, but no relay is required.

An AD7528 (IC11) dual 8-bit multiplying digital-to-analog converter (DAC) is used to provide a threshold voltage for each high impedance amplifier. That type of DAC provides only a current output, so each of the two outputs is converted to a voltage with one section of IC12 (IC12-a and IC12-b), a TL074 quad operational amplifier. Two additional op-amps (IC12-c and IC12-d), configured as adders, convert the unipolar outputs of the first two op-amps to bipolar signals. The 2.5-volt reference voltage for each DAC is provided by IC13, and AD580 voltage reference.

The addition of an edge-detection circuit (Fig. 4) allows a pulse width to be measured. Two

74HCT74 D-type flip flops (IC19-a and -b) and two 74HC00 NAND gates (IC20-a and -b) form rising and falling edge detection circuits; IC20-a provides an active-low pulse, one timebase clock long, each time a rising edge is detected, and IC20-b provides a pulse for each falling edge. A 74HC157 quad two-input multiplexer (IC21) selects which edge detector goes to input C or D of the OE10. If a rising-edge pulse is sent to input C and a falling-edge pulse is sent to input D, positive-going pulse widths will be measured. The opposite selection measures negative-going pulse widths.

The PC10 provides a single 50-ohm input amplifier (see Fig. 5), typically used for input from RF circuits. The incoming signal is first amplified by IC25 and IC26, monolithic microwave integrated circuit (MMIC) 50-ohm amplifiers, each with a gain of 11 to 20

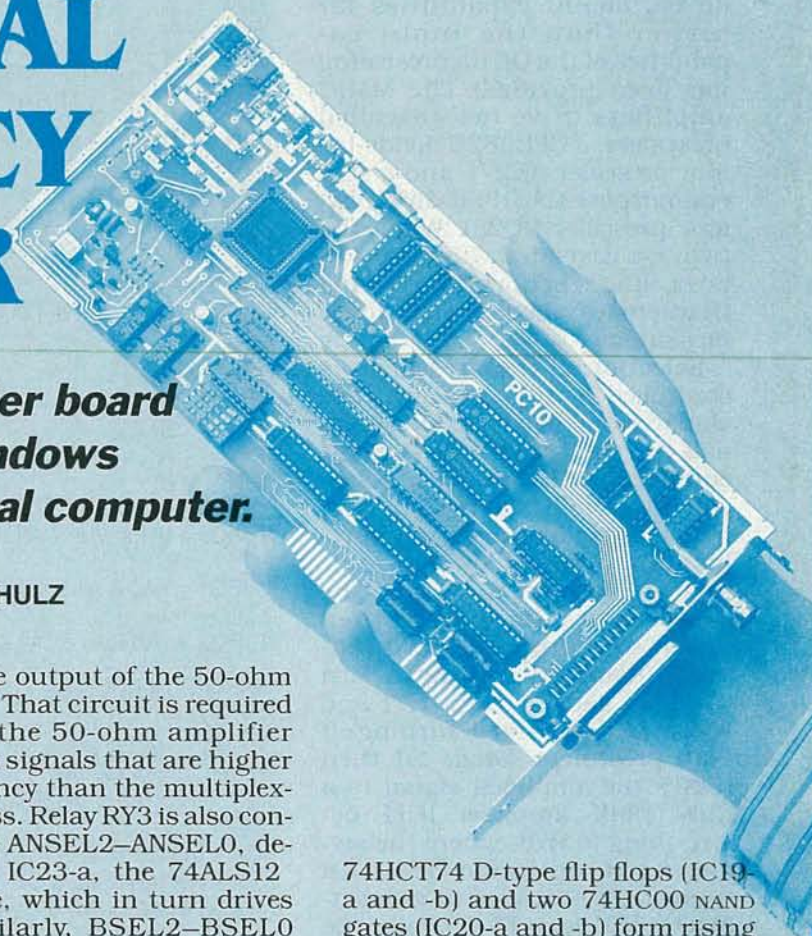

dB. Each amplifier is powered from +5 volts through a 75-ohm resistor, a 100- μ H inductor, and several decoupling capacitors. Those components supply power to each amplifier and prevent high-frequency signals from entering the power-supply rails.

In order to provide frequency-measurement capabilities far higher than the input capabilities of the OE10, prescaling has been provided. The MMIC amplifiers drive two cascaded prescalers: a UPB582C divide-by-four prescaler (IC27), and a general-purpose CA3199E divide-by-four prescaler (IC28). When the two are cascaded, divide-by-16 prescaling is performed, allowing frequencies above 3 GHz to be measured.

Selection of the prescalers is controlled by the PRE1 and PRE0 signals from register 1. Those signals drive an LM339 quad voltage comparator (IC24), with a 2.5-volt threshold set by R15 and R16. If direct frequency measurements are required, PRE1 and PRE0 are both set to logic 0. The comparators' inputs are then driven below the threshold voltage, causing Q1 and Q2 to turn off. That causes relays RY1 and RY2 to be deactivated, turning off both prescalers. Diode D1 then routes the amplified signal to a third MMIC amplifier, IC11, before going to RY3, where the signal is sent on to the OE10. An input-bias adjustment potentiometer R31 is used to center the output of the MMIC amplifier at approximately 1.5 volts for best performance.

If measurements prescaled by 4 are required, PRE1 is set to logic 0 and PRE0 set to logic 1. That causes comparator IC24-c to activate, turning on Q1 and RY1. That forces IC27 to begin prescaling the signal, deactivates D1, activates D2, and routes the output of prescaler IC27 to the MMIC amplifier. Conversely, if measurements prescaled by 16 are required, PRE1 must be set to logic 1 and PRE0 to logic 0. That turns on both relays, causing both prescalers to start. Diodes D1 and D2 are then deactivated, sending the output of the second prescaler IC28 to the MMIC amplifier. The PC10's bypass capacitors and unused logic gates are shown in Fig. 6.

LISTING 1

DEVICE	20V8;
TITLE	PC COUNTER BOARD SELECTION LOGIC;
NAME	Bill Schulz;
SIGNATURE	COUNTER;
PIN 1	= A0;
PIN 2	= A1;
PIN 3	= A2;
PIN 4	= A3;
PIN 5	= A4;
PIN 6	= A5;
PIN 7	= IOW;
PIN 8	= IOR;
PIN 9	= AEN;
PIN 10	= S6;
PIN 11	= S7;
PIN 13	= S8;
PIN 14	= S9;
PIN 17	= COMP;
PIN 18	= DAC;
PIN 19	= REG2;
PIN 20	= REG1;
PIN 21	= OE10;
PIN 22	= G;
PIN 16	= RT;
PIN 23	= RESET;

!DAC = !A1 & !A2 & A3 & A4 & !A5 & S6 & S7 & S8 & S9 & !AEN;

!REG1 = !A0 & A1 & !A2 & A3 & A4 & !A5 & S6 & S7 & S8 & S9 & !AEN & !IOW & IOR;

!REG2 = A0 & A1 & !A2 & A3 & A4 & !A5 & S6 & S7 & S8 & S9 & !AEN & !IOW & IOR;

!COMP = !A0 & !A1 & A2 & A3 & A4 & !A5 & S6 & S7 & S8 & S9 & !AEN & IOW & !IOR;

!OE10 = !A3 & !A5 & S6 & S7 & S8 & S9 & !AEN
 | !A4 & !A5 & S6 & S7 & S8 & S9 & !AEN
 | !A0 & !A1 & A2 & !A5 & S6 & S7 & S8 & S9 & !AEN;

!G = !A3 & !A5 & S6 & S7 & S8 & S9 & !AEN
 | !A4 & !A5 & S6 & S7 & S8 & S9 & !AEN
 | !A1 & !A2 & !A5 & S6 & S7 & S8 & S9 & !AEN
 | !A2 & !A5 & S6 & S7 & S8 & S9 & !AEN & !IOW & IOR
 | !A0 & !A1 & !A5 & S6 & S7 & S8 & S9 & !AEN & IOW & !IOR;

!RT = RESET
 | !A0 & A1 & A2 & A3 & A4 & !A5 & S6 & S7 & S8 & S9 & !AEN & !IOW & IOR;

AP10H amplifier board

Because the insides of personal computers are electrically noisy, no high-impedance amplifiers are provided on the PC10. Instead, two high-impedance amplifiers are provided on an optional external amplifier board, the AP10H. That board, shown in Fig. 7, contains two identical 100-MHz high-impedance amplifiers, each with input attenuation, a low-pass filter for measuring low-frequency signals, and a variable threshold-level adjust. We will therefore discuss only one of the amplifier circuits.

Starting from the input BNC

connector (J1), the input signal is terminated by R1 and R2 and C2 and C3. An attenuation of 20 dB is provided if RY1 is enabled. The signal is then sent through the input-protection circuits (D1-D4, R4, and R5) into the gate of an RF FET transistor Q1, which acts as an impedance converter, providing a low-impedance source to the remainder of the amplifier. The signal is then amplified by 20 dB by MMIC amplifier IC1. Relay RY2, when activated by Q3, low-pass filters the signal to provide noise-free measurements of low-frequency audio signals. Potentiometer R9 is

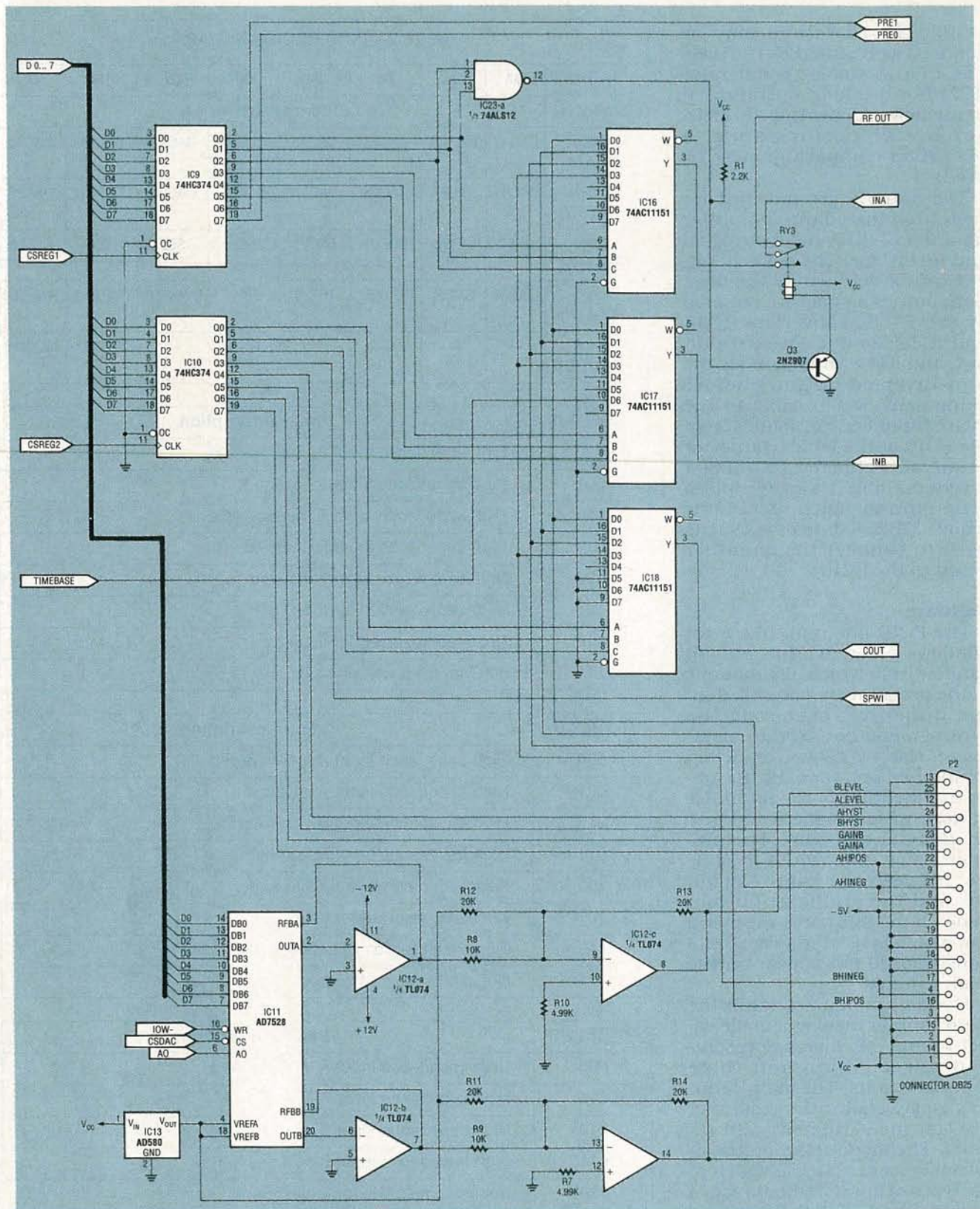

FIG. 3—TWO 74HC374 EIGHT-BIT REGISTERS (IC9 and IC10) control operation of the PC10.

adjusted so that the input to the variable threshold circuit formed around voltage-comparator IC2 will be 0 volts.

The variable threshold circuit allows the user to position the threshold to the best value to ensure accurate, noise-free mea-

surements. The circuit provides 50 mV of hysteresis to give immunity to noise. The hysteresis window is centered around the threshold voltage provided by the dual-threshold DAC's on the

PC10. The threshold may be changed as required by the user. The LT1016 voltage comparator (IC2) is capable of operating at frequencies greater than 50 MHz. For better performance, a MAX9689 comparator may be used.

Two outputs are provided for each high-impedance amplifier from the LT1016; the true signal and its inverse. The desired output can be selected by the user. Both output signals are buffered by two 74LS04 inverters (IC3-f and IC3-a for the inverted output, and IC3-e and IC3-b for the non-inverted output) before being sent over a cable to the PC10. Input control signals from the PC10 at the DB25 connector P1 are also buffered by 74LS04 inverters. Table 3 is a description of the pin assignments for P1, the female DB25 connector that is used to connect the amplifier board to the PC10.

Software

The PC10 program, like most Windows programs, has a main window from which all functions of the program are controlled. In the upper-left corner is the *control-menu box* used to move, resize, close windows, or switch to another program. In the upper-right corner is the *minimize button*, which reduces the program to its OEI icon. The program name is shown in the title bar between the control-menu box and the minimize button. Beneath the title bar is the menu bar, which is used to select functions that do not appear on the main window.

The main window contains the main counter display, a mode-select group, gate/average/resolution select group, and three control buttons. The main counter display shows the results of the last measurement and its units. The mode-select group allows the user to choose which of five types of measurements are to be performed. The gate/average/resolution box allows the user to determine the gate time (frequency measurements), number of measurements to average (period, time interval, and pulse width), or the resolution (ratio measurements). For frequency or period measurements, reciprocal

Address	D7	D6	D5	D4	D3	D2	D1	D0
00000-10111	OE10 Registers (see Table 1)							
11000 DACA (W)	DACA7	DACA6	DACA5	DACA4	DACA3	DACA2	DACA1	DACA0
11001 DACB (W)	DACB7	DACB6	DACB5	DACB4	DACB3	DACB2	DACB1	DACB0
11010 REG1 (W)	PRE0	PRE1	BSEL2	BSEL1	BSEL0	ASEL2	ASEL1	ASEL0
11011 REG2 (W)	GAINA	GAINB	BHYST	AHYST	SPWI	PWSEL2	PWSEL1	PWSEL0
11100 MCOMP (R)	—	—	—	—	—	—	BCNF	MCOMP

ASEL2-0	Input Description
000	High Impedance Input A, non-inverted
001	High Impedance Input A, inverted
010	High Impedance Input B, non-inverted
011	High Impedance Input B, inverted
100	Not used, reserved for future use
101	Not used, reserved for future use
110	Not used, reserved for future use
111	50-Ohm Input with prescale

BSEL2-0	Input Description
000	High Impedance Input A, non-inverted
001	High Impedance Input A, inverted
010	High Impedance Input B, non-inverted
011	High Impedance Input B, inverted
100	Not used, reserved for future use
101	Not used, reserved for future use
110	Timebase Oscillator (10.000 MHz)
111	Not used, reserved for future use

PWSEL2-0	Input Description
000	High Impedance Input A, non-inverted
001	High Impedance Input A, inverted
010	High Impedance Input B, non-inverted
011	High Impedance Input B, inverted
100	Not used, reserved for future use
101	Not used, reserved for future use
110	Not used, reserved for future use
111	Not used, reserved for future use

measurements may be selected by activating the reciprocal check box.

For frequency measurements, the gate group will be shown. The user can select four gate times,

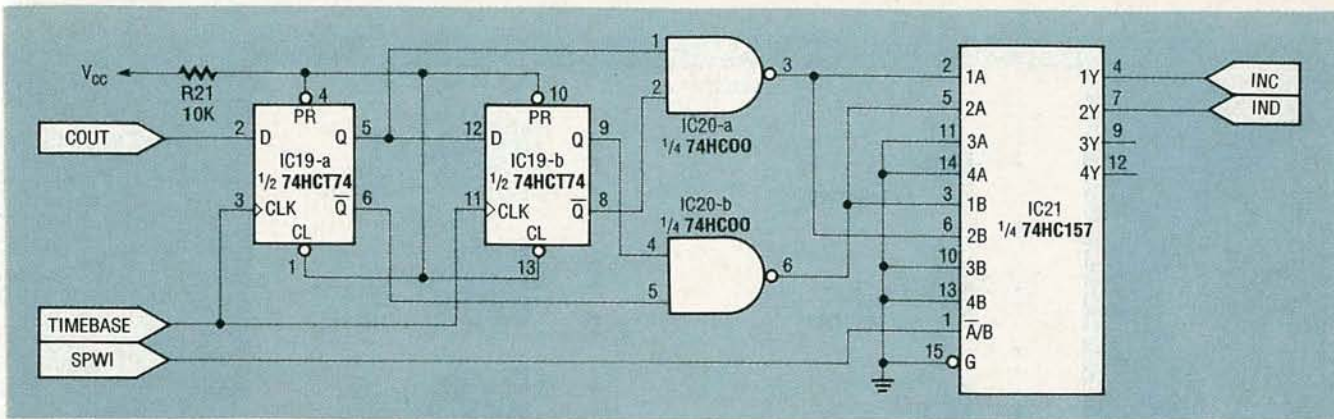

FIG. 4—AN EDGE-DETECTION CIRCUIT allows a pulse width to be measured.

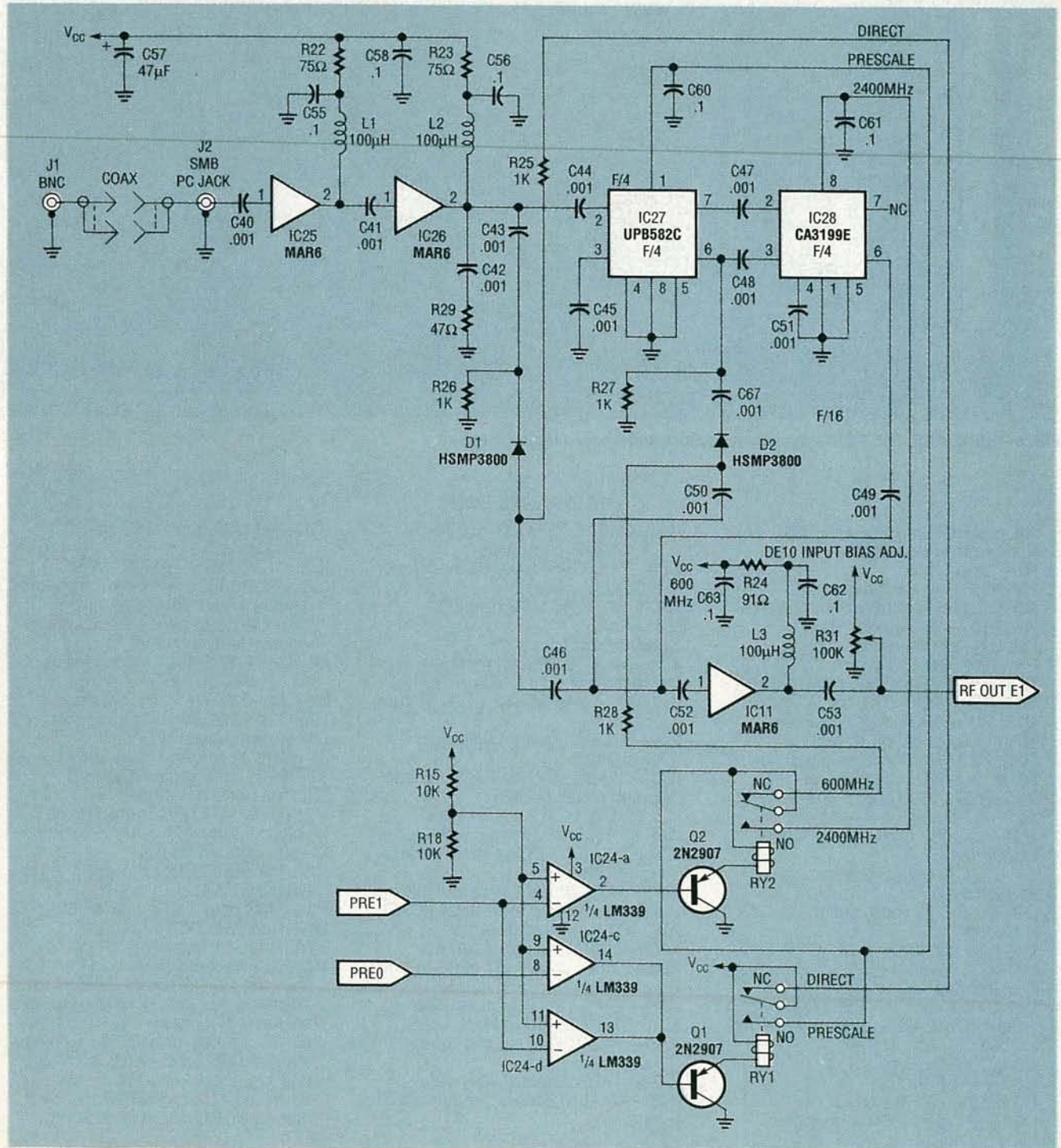

FIG. 5—THE PC10 PROVIDES a single 50-ohm input amplifier typically used for input from RF circuits.

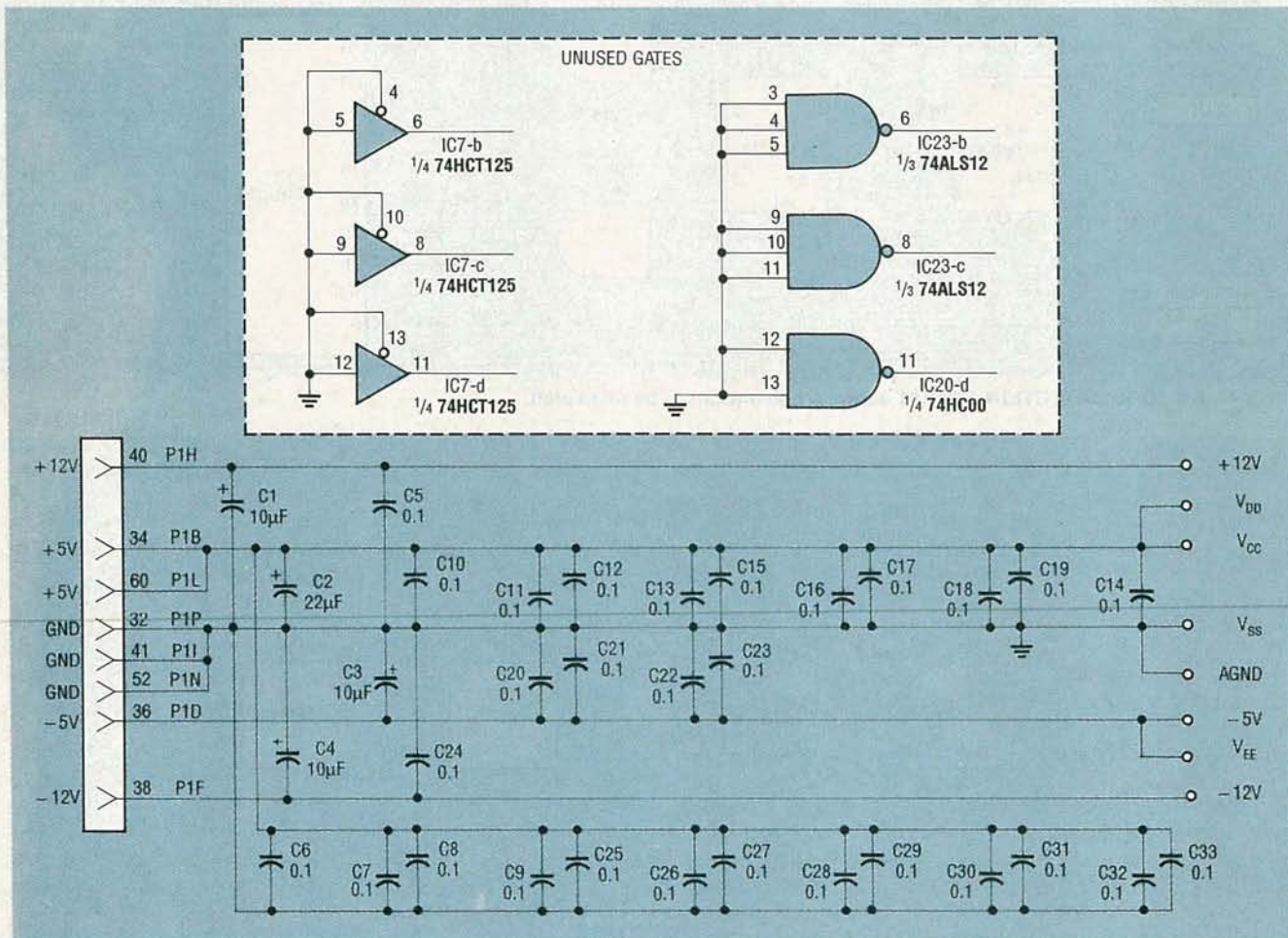

FIG. 6—HERE ARE THE PC10's bypass capacitors and unused logic gates.

PC10 PARTS LIST

All resistors are 1/4-watt, 5%, unless otherwise noted

- R1—2200 ohms
- R2, R30, R32—not used
- R3—R6, R21—10,000 ohms, 1/8 watt
- R7, R10—4990 ohms, 1%
- R8, R9—10,000 ohms, 1%
- R11—R14—20,000 ohms, 1%
- R15, R16, R21—10,000 ohms, 1/8 watt
- R17, R30—75,000 ohms, 1/8 watt
- R18, R20—1000 ohms, 1/8 watt
- R19—33,000 ohms, 1/8 watt
- R22, R23—75 ohms, chip resistor
- R24—91 ohms, chip resistor
- R25—R28—1000 ohms, chip resistor
- R29—47 ohms, chip resistor
- R31—100,000-ohm potentiometer

Capacitors

- C1, C3, C4—10 μ F, 25 volts, radial electrolytic
- C2—22 μ F, 25 volts, radial electrolytic
- C5—C7, C9—C12, C14, C16—C19, C24, C26—C33—0.1 μ F, 50 volts, monolithic
- C8, C13, C15, C20—C23, C25, C51, C54, C59, C64—C66, C68—not used
- C34, C36—330 pF, NPO
- C35—47 pF, NPO
- C37, C38—8.2 pF, NPO
- C39—2-7 pF NPO trimmer

- C40—C50, C52, C53, C67—0.001 μ F, 1206 chip capacitor
- C55, C56, C58, C60—C63—0.1 μ F, 1206 chip capacitor
- C57—47 μ F, 16 volts, radial electrolytic

Semiconductors

- IC1—74HCT245 octal tristate transceiver
- IC2, IC3—74HCT244 octal tristate buffer
- IC4—20L8 programmable array logic (PAL)
- IC5—OE10 application-specific integrated circuit (ASIC)
- IC6, IC8, IC14, IC15—not used
- IC7—74HCT125 tristate quad buffer
- IC9, IC10—74HC374 tristate octal D-type flip-flop
- IC11—AD7528 dual 8-bit multiplying digital-to-analog converter (DAC)
- IC12—TL074 quad op-amp
- IC13—AD580 voltage reference
- IC16—IC18—74AC11151 eight-to-one multiplexer
- IC19—74HCT74 D-type flip-flop
- IC20—74HC00 quad NAND gate
- IC21—74HC157 quad two-input multiplexer
- IC22—74LS86 quad XOR gate
- IC23—74ALS12 triple 3-input NAND gate

- IC24—LM339 quad voltage comparator
- IC25, IC26, IC29—MAR6 MMIC
- IC27—UPB582C high-performance divide-by-four prescaler
- IC28—CA3199E general-purpose divide-by-four prescaler
- D1, D2—HSMP3800 surface-mount pin diode
- Q1—Q3—2N2907 PNP transistor
- Q4, Q5—PN2369 NPN transistor

Other components

- J1—BNC bulkhead (R141-306)
- J2—SMB right-angle PC board connector (R114-665)
- RY1—RY3—SPDT DIP reed relay, 5-volt coil (form 1C)
- L1—L3—100 μ H choke
- P2—female DB25 connector (ITT DBU-25S-AA)
- P3—SMB plug, cable (R114-082)
- S1—4-position DIP switch
- XTAL1—10-MHz crystal

Miscellaneous: seven 14-pin IC sockets, four 16-pin IC sockets, six 20-pin IC sockets, one 24-pin IC socket (0.3-inches), one PLCC 44-pin IC socket, one G57 modified stamped PC bracket (Globe Mfg.), one lug (Zierick #334), 6-inch 50-ohm coaxial cable RG187 (0.1-inch diameter), PC board, solder, etc.

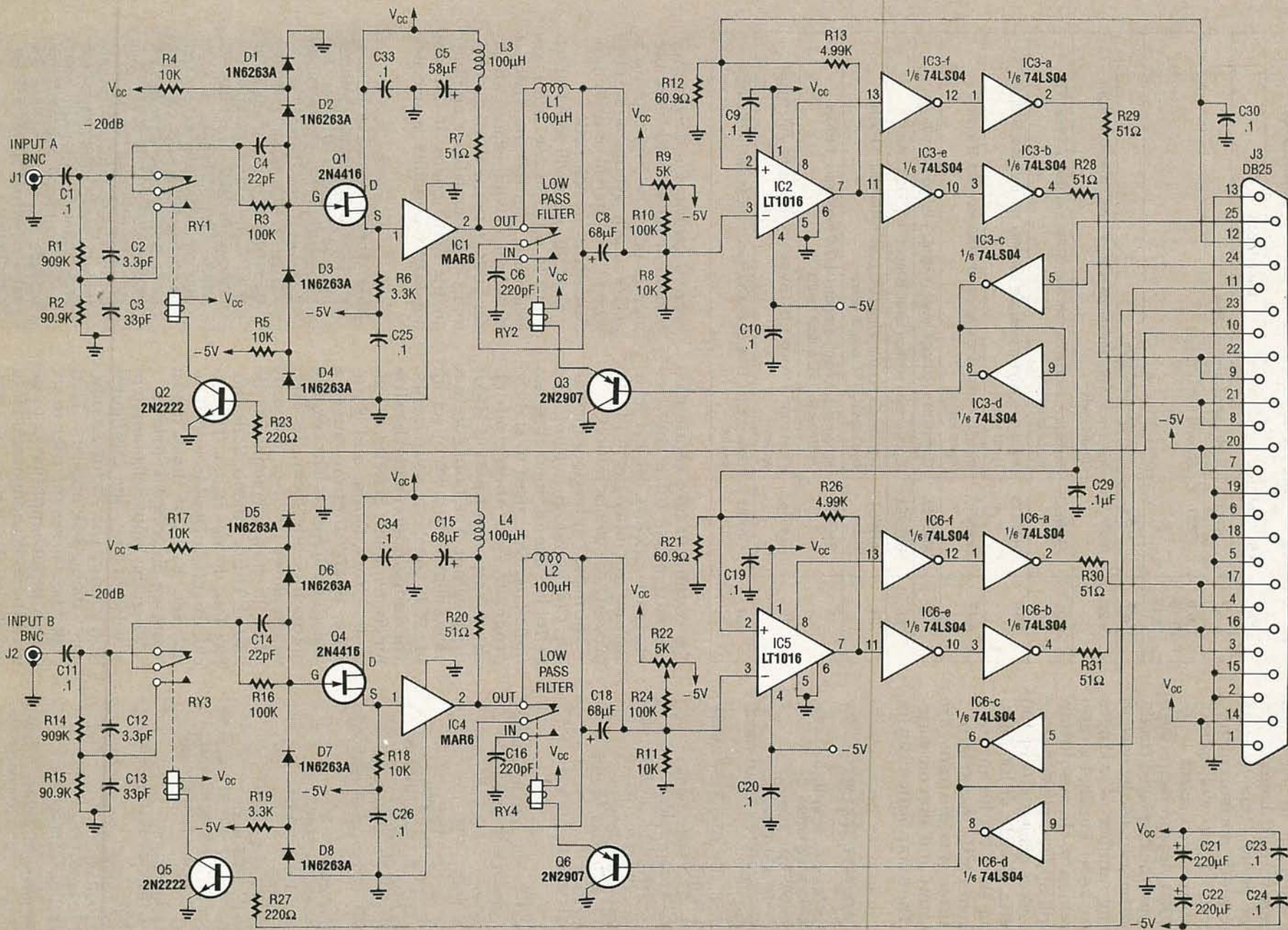

FIG. 7—THE INSIDES OF PERSONAL COMPUTERS are electrically noisy, so there are no high-impedance amplifiers provided on the PC10 board. Instead, two high-impedance amplifiers are provided on this AP10H optional external amplifier board. It contains two identical 100-MHz high-impedance amplifiers, each with input attenuation, a low-pass filter for measuring low-frequency signals, and a variable threshold-level adjust.

0.01, 0.1, 1.0, or 10.0 seconds, or use the scroll bar to select any gate time between 0.1 and 28 seconds. For period, time-interval, or pulse-width measurements, the average group will appear. The user can then select 1, 10, 100, or 1000 measurements averaged to give the displayed result. The scroll bar can also be used to select any number of averages from 10 to 2800. Finally, for ratio measurements, the resolution group will appear, allowing the user to select resolutions of 100 kHz, 1 MHz, 10 MHz, or 100 MHz, or use the scroll bar for any resolution from 1 MHz to 280 MHz.

The three pushbuttons are used to start and stop measurements. The START button causes

AP10H PARTS LIST

All resistors are 1/4-watt, 5%, unless otherwise noted

R1, R14—909,000 ohms, 1%
 R2, R15—90,900 ohms, 1%
 R3, R10, R16, R24—100,000 ohms, 1/8 watt
 R4, R5, R8, R11, R17, R18—10,000 ohms, 1/8 watt
 R6, R19—3300 ohms, 1/8 watt
 R7, R20—51 ohms, chip
 R9, R22—5000-ohm potentiometer
 R12, R21—60.9 ohms, 1%
 R13, R26—4990 ohms, 1%
 R23, R27—220 ohms, 1/8-watt
 R25—not used
 R28—R31—51 ohms, 1/8-watt

Capacitors

C1, C9—C11, C19, C20, C23—C26, C29, C30—0.1 μ F, 50 volts, monolithic
 C2, C12—3.3 pF, chip
 C3, C13—33 pF, chip
 C4, C14—22 pF, monolithic
 C5, C8, C15, C18— μ F, tantalum
 C6, C16—220 pF, chip
 C7, C17, C27, C28—not used
 C21, C22—220 μ F, axial electrolytic

Semiconductors

IC1, IC4—MAR6 MMIC
 IC2, IC5—LT1016 voltage comparator
 IC3, IC6—74LS04 inverter
 D1—D8—1N6263A diode
 Q1, Q4—2N4416 RF FET transistor
 Q2, Q5—2N2222 NPN transistor
 Q3, Q6—2N2907 PNP transistor

Other components

J1, J2—CP1094U BNC connector, modified
 RY1—RY4—SPDT DIP reed relay, 5-volt coil (form 1C)
 L1—L4—100 μ H choke
 J3—male DB25 connector

Miscellaneous: PC board, suitable enclosure, 6-foot 25-conductor straight-through cable, solder, etc.

TABLE 3—PC10 TO AP10H AMPLIFIER BOARD CONNECTOR

Pin	Pin Name	Description
1,14	VCC	+5V supply from PC Bus
2,5,6 13,15, 18,19	GND	Ground from PC Bus
7,20	-5V	-5V from PC Bus
9,22	AHIPOS	Input from high impedance amplifier, not inverted, A input, TTL input levels
8,21	AHINEG	Input from high impedance amplifier, inverted, A input, TTL input levels
3,16	BHIPOS	Input from high impedance amplifier, not inverted, B input, TTL input levels
4,17	BHINEG	Input from high impedance amplifier, inverted, B input, TTL input levels
12	ALEVEL	Comparison voltage level, A input, -2.5 to 2.5 volts
25	BLEVEL	Comparison voltage level, B input, -2.5 to 2.5 volts
24	AHYST	Hysteresis control, A input, 0 LOW hysteresis, 1 HIGH hysteresis, TTL output levels
11	BHYST	Hysteresis control, B input, 0 LOW hysteresis, 1 HIGH hysteresis, TTL output levels
10	GAINA	Gain control, A input, 0 LOW gain, 1 HIGH gain, TTL output levels
23	GAINB	Gain control, B input, 0 LOW gain, 1 HIGH gain, TTL output levels

the counter to take continuous measurements until the STOP button is clicked. Single measurements may be made by pressing the SINGLE button.

The menu bar has four menus: File, Configuration, Logging, and SetRadio. The File menu has two functions: Exit, used to end the program, and About, which shows some information about the program. The Configuration menu allows the user to set up the PC10 to take measurements. The Configuration menu has five functions: Input Selection, Calibrate, Units, Fonts, and Hardware. Each function causes a dialog box to appear. The Logging menu has one item, To File, which allows the user to specify what file measurements will be logged. The last menu, SetRadio, has four items: Radio, Threshold, Enable or Disable, and Manual Set. Each of those menu items are described as follows.

When the Input Selection item is selected from the Configuration menu, the Input Assignment dialog box appears. That dialog box allows the user to set which input amplifier is to be used and what configuration is to be selected. Two groups are available: the Input group and the Ref-

erence group. For frequency, period, or pulse-width measurements, only the Input group is active. Both groups are active when time-interval or ratio measurements are selected.

First, the user will select which input (A or B) to use. If A is selected, the user has the choice of either the low-impedance amplifier built-in to the PC10 or the A-input high-impedance amplifier on the AH10 board. If the low-impedance amplifier is selected,

Note: The following items are available from Optoelectronics Inc., 5821 N.E. 14th Ave., Ft. Lauderdale, FL 33334 (800) 327-5912, in Florida (305) 771-2050, FAX (305) 771-2052: Complete Kit of all parts to build the PC10, including software, \$299; OE10 ASIC, \$49; PC10 PC board, \$59; software, \$5; programmed PAL, \$19; assembled and tested PC10, \$339; complete kit of all parts to build the AP10H, \$179; AP10H PC board, \$39; machined and painted cabinet, \$49; 6-foot 25-conductor straight-through cable, \$20; assembled and tested AP10H, \$229. Send SASE for priced out parts list. Include 5% shipping and 6% sales tax when shipped to Florida address.

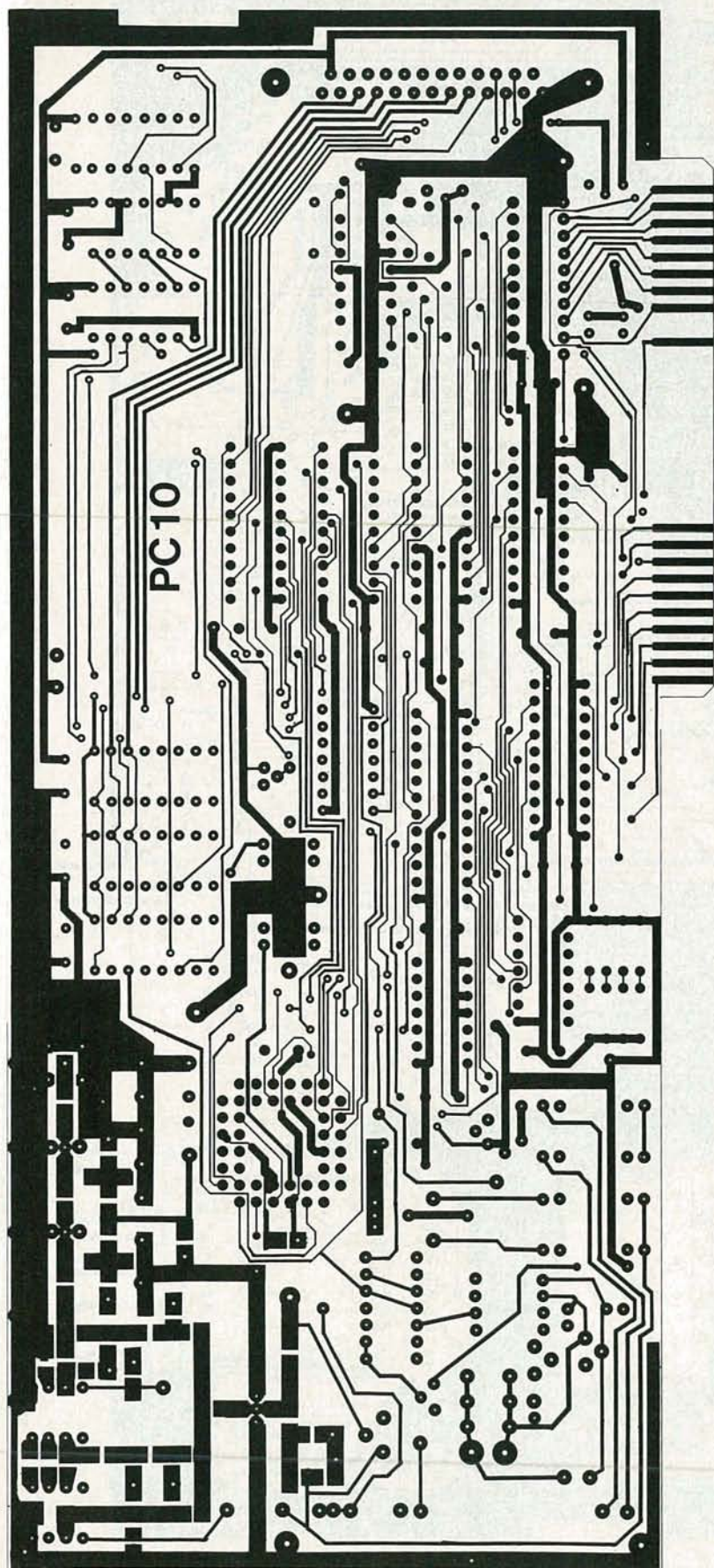

9 1/4 INCHES

FOIL PATTERN for the component side of the PC10 board.

the user can choose no prescale, prescale by 4 or prescale by 16. The remaining items are grayed, indicating that they may not be chosen. If the high-impedance amplifier is chosen, the user can choose to include low-pass filtering. Signal polarity may be set to positive or negative. Last, the voltage threshold may be changed to any value between -0.5 and $+2.5$ volts.

The Calibrate dialog box appears when the Configuration menu item "Calibrate" is chosen. That dialog box allows the user to calibrate in software the time-base of the PC10 from an external frequency source. Before selecting this item, the user must first set up the Input Assignments dialog for the proper input. The user then enters the reference frequency and hits the OK push-button. The dialog box will disappear and a dialog box giving the measured reference frequency will appear after about 25 seconds. The user can confirm that measurement by hitting the OK button. The reference frequency will then be stored in the WIN.INI file in the Counter section.

The Units dialog box, which appears when the Units item is selected from the Configuration menu, allows the unit of measurement to be selected. For frequency measurement, Hz, kHz, MHz, GHz, and RPM/CPM (revolutions or cycles per minute) may be chosen. For period, interval and pulse-width measurements, seconds, milliseconds, microseconds, or nanoseconds may be selected.

The Fonts dialog box appears whenever the Fonts item is selected from the Configuration menu. That dialog box allows the user to select the font and its size to match the user's video configuration. The selected font is then stored in the WIN.INI file in the Counter section.

The Hardware dialog box appears the first time the program is run, or whenever the Hardware item on the Configuration menu is selected. That allows the user to inform the Windows program what DIP switches are set on the PC10 board. The user checks boxes on the menu to match the setting on the PC10 board.

The Logging dialog box, which appears when the To File item is

selected on the Logging menu, informs the Windows program of the file chosen to log measurements. The filename of the logging file is entered into an edit box. The user can also select if time, date, and units information is to be stored with each measurement.

The Radio Select dialog box appears when the Radio item is selected from the SetRadio menu. That allows the user to select which radio the frequency measurement will be sent. One radio from a list of more than 10 radios may be chosen, and the choice will be saved in the WIN.INI file in the Counter section.

Whenever the Threshold item is selected from the SetRadio menu, the SetRadio Threshold dialog box appears. That allows the user to filter frequency measurements so that only valid measurements from strong signals are sent to the radio. The user selects how close successive measurements must be to each other, and how many consecutive measurements must appear before sending the measurement to the radio.

The Enable menu item on the SetRadio menu enables the PC10 to send frequency measurements meeting the requirements set in the SetRadio Threshold dialog box to the selected radio. If sending measurements is enabled, the menu item will change to Disable, allowing the user to stop sending measurements.

The ManualSet menu item on the SetRadio menu sends the last frequency measurement value directly to the selected radio. It bypasses the filtering performed by the SetRadio Threshold dialog box.

The program icon (also displayed on the ABOUT dialog box) is the Optoelectronics, Inc. logo. The software is available as mentioned in the sources box, and will also be posted on the RE-BBS (516 293-2283) as COUNTER.EXE.

Assembly

The PC10 mostly contains socketed IC's and leaded parts conventionally mounted. However, there are also some surface-mount components in the RF section. Figure 8 shows the parts-placement diagram for the PC10 board.

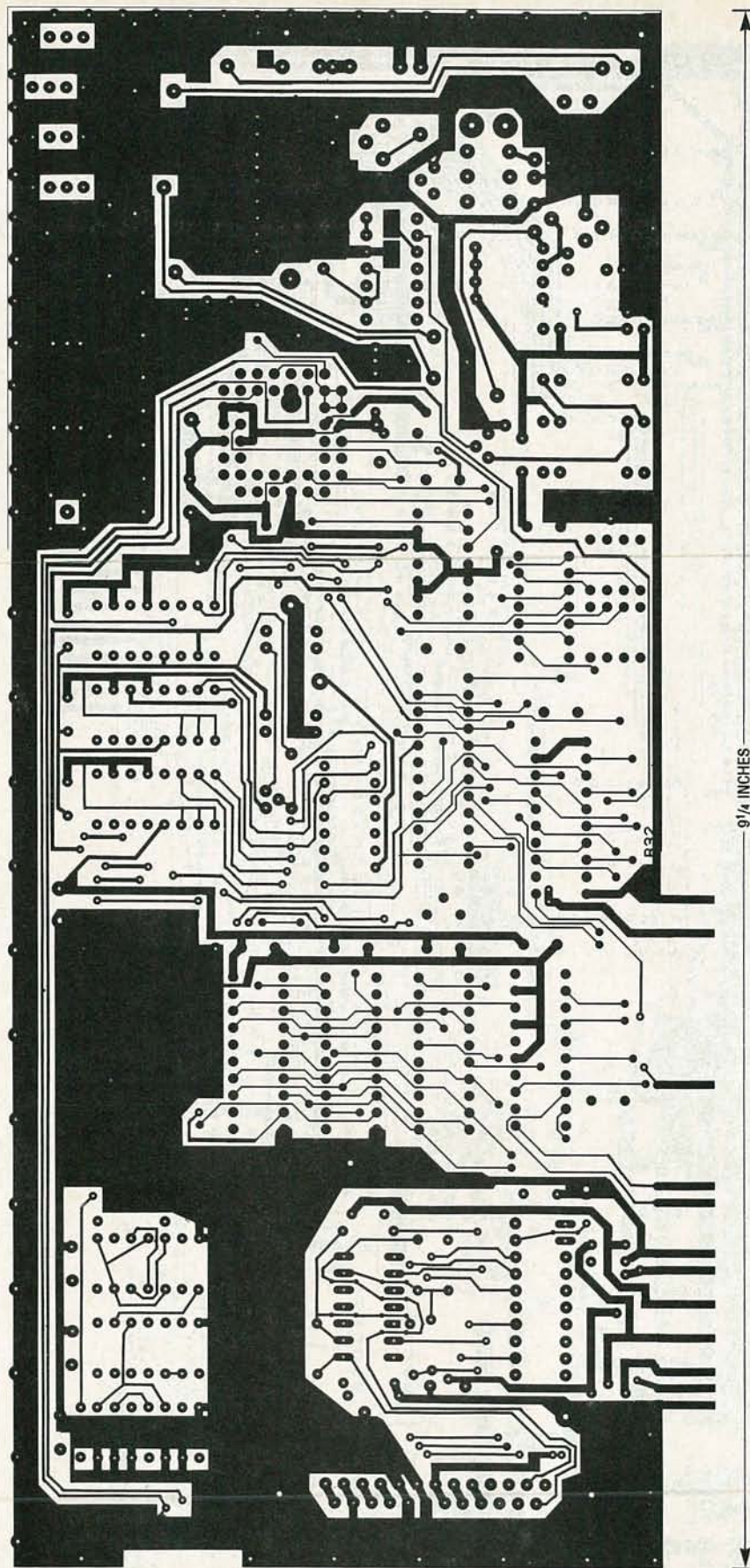

FOIL PATTERN for the solder side of the PC10 board.

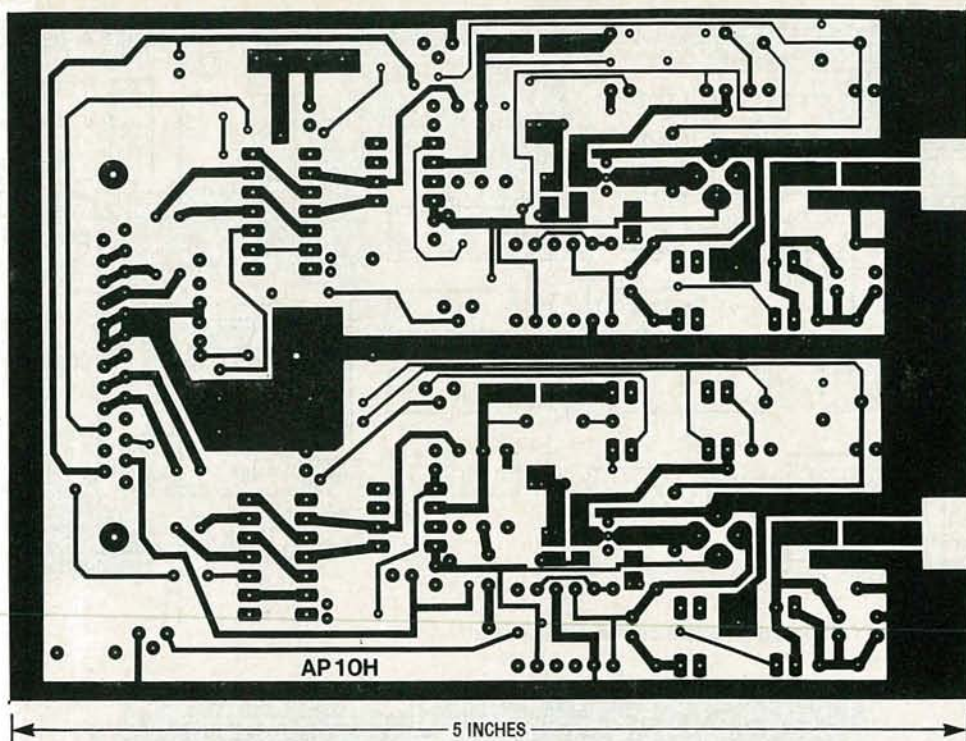

FOIL PATTERN for the component side of the AP10H board.

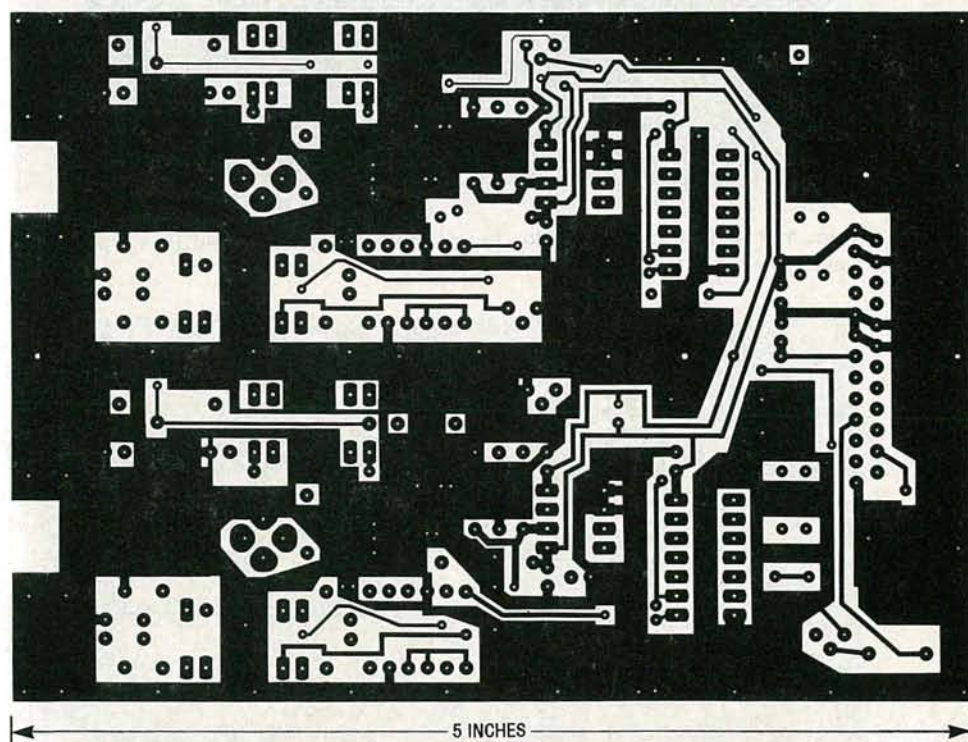

FOIL PATTERN for the solder side of the AP10H board.

You will notice that, in Fig. 8, certain parts and groups of parts are labeled G1 and G2. This project can be built for several different applications and, depending on the application, certain parts can be left off the board for significant cost savings.

To build a 10-MHz-to-2.4-GHz RF frequency counter, all G1 parts must be installed, and G2 parts can be omitted. In that case, the AP10H amplifier is not needed. To build a 10-Hz-to-100-MHz universal counter, all G2 parts must be installed, and G1

parts can be omitted; the AP10H is required. Otherwise, for a 10-Hz-to-2.4-GHz universal counter, all G1 and G2 parts must be installed and the AP10H is also required.

Also note points E1, E2, and E3 as indicated in Fig. 8. Normally, for the G0 version (all G1 and G2 parts installed), you must jumper point E1 to point E2 using a short piece of shielded coaxial cable. For the G1 version (G2 parts left out), jumper E1 to E3. For the G2 version (G1 parts left out), no jumper is required.

Install the surface-mount resistors and capacitors first while the PC board is open. If you haven't tried chasing a 1206 sized component all over the place with your soldering iron then here is your chance. While it does require some expertise, you will quickly learn the technique.

Melt a small amount of solder on one of the PC-board pads where the part is to go. Use a small pick to hold the part in place while heating the solder. Continue holding the part in place while the solder cools. After you are satisfied, solder the other end of the part to the PC board. Do not attempt to move or push against the part after one end has been soldered or you will stress the part and may damage it.

The PIN diodes have "DO" on top and look like surface-mount transistors. Solder them in place with the side of a single leg pointing to the top of the PC board.

The MMIC's must be installed with the input lead pointing toward the right (gold fingers down). The input lead is marked on the body (you may need a magnifier to see it). Trim the leads to fit on the PC lands between the capacitors. The two remaining leads are bent down to pass

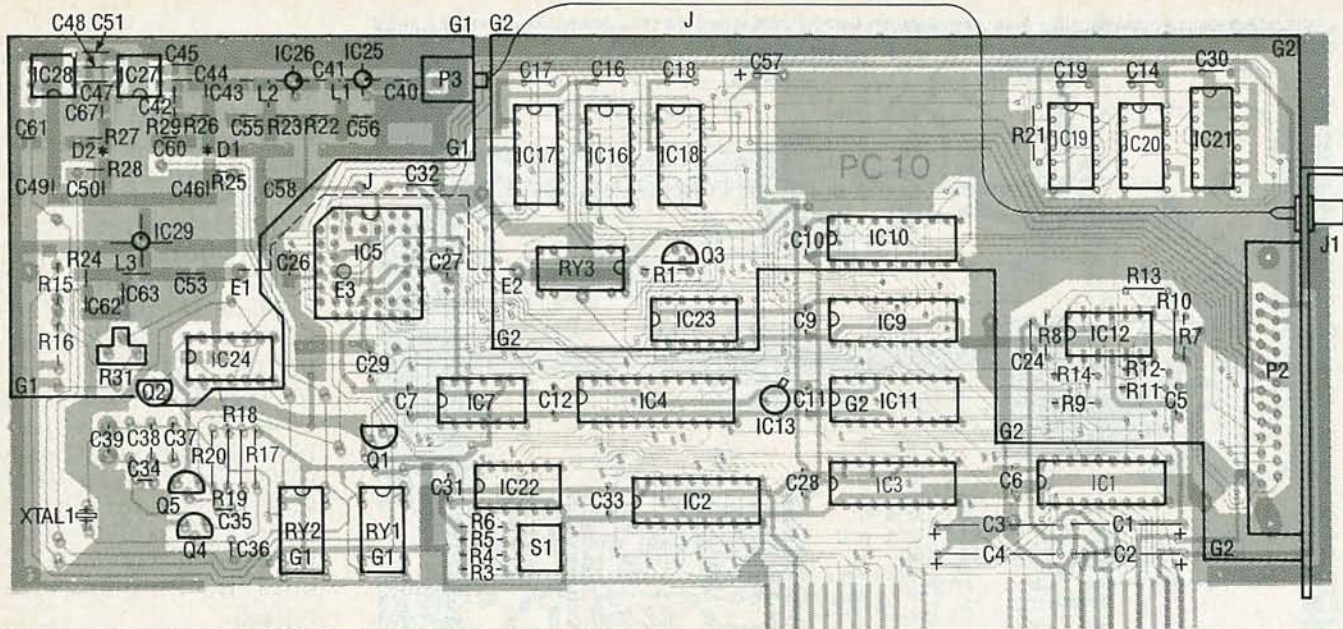

FIG. 8—PARTS-PLACEMENT DIAGRAM for the PC10 board. See text concerning special instructions for G1 and G2 parts.

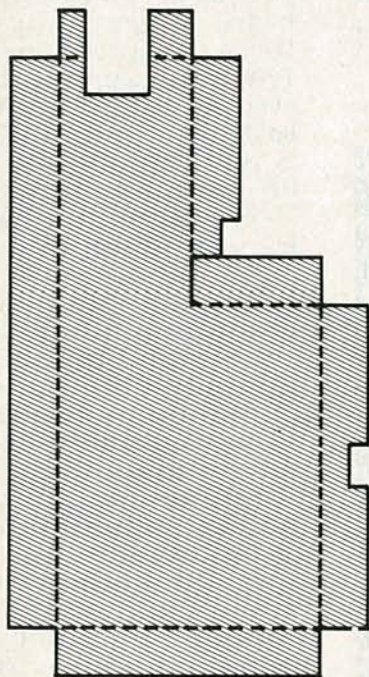

FIG. 9—HERE IS AN ACTUAL-SIZE template for a brass RF shield that goes over the surface-mount input section of the PC10 board.

through the PC board where they are soldered. Note that the body of the MMIC will fit in the hole drilled through the PC board. Solder the input and output leads first and then the two ground leads.

The three 100- μ H chokes are soldered directly to the PC foil where indicated. Solder the two 8-pin prescaler chips into the PC board where indicated for the best possible high-frequency per-

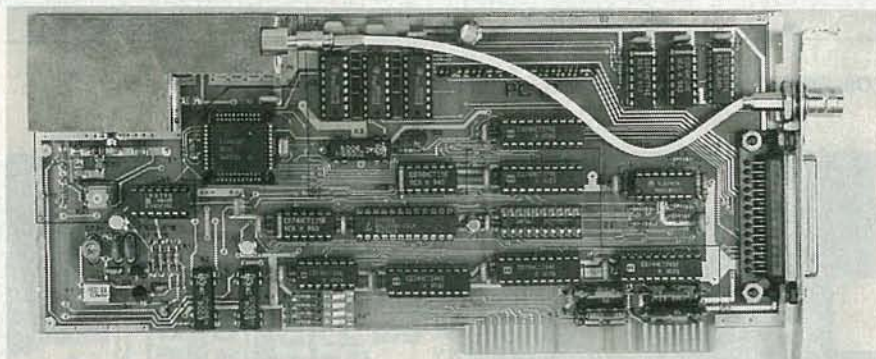

FIG. 10—THE FINISHED PC10 BOARD. Notice how the brass RF shield goes in place over the input section of the board.

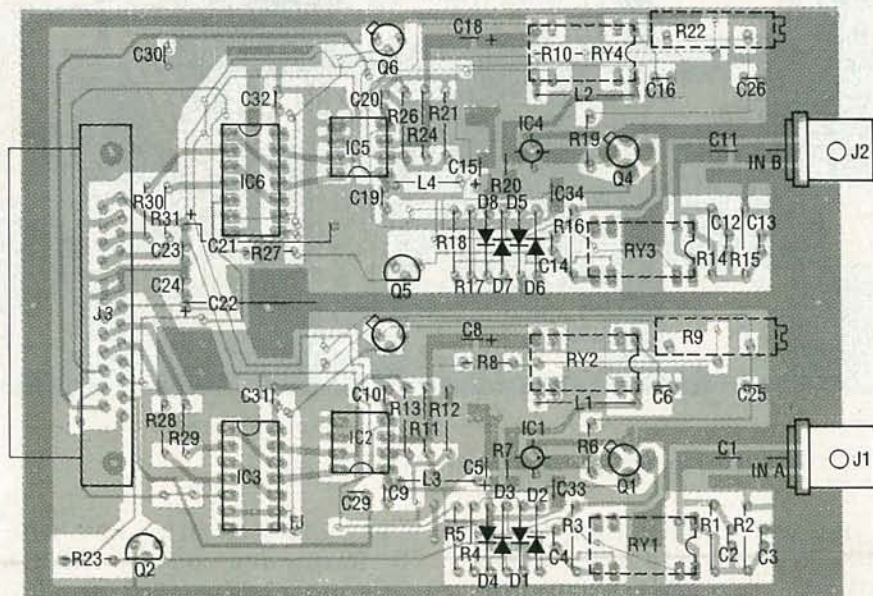

FIG. 11—PARTS-PLACEMENT DIAGRAM for the AP10H board.

formance. Do not socket the 74HC157 because it will interfere with the BNC input connector.

Place and solder the 44-pin PLCC socket with the truncated

continued on page 62

LAST MONTH WE DISCUSSED ALL OF the operating theory concerning the audio sweep/marker generator. Now let's build the unit.

Construction and checkout

There are two PC boards in this unit: the power-supply board, which includes the peak-hold circuit, and the main sweep/generator board. Etched and drilled PC boards are available from the source in the parts list. The prototype uses a Jameco enclosure type H2507, but any thermoplastic or metal enclosure with the proper openings for control shafts and jacks will serve the purpose. An internal view of the sweep/generator is shown in Fig. 10.

Assemble the power supply/peak-hold board according to the parts layout shown in Fig. 11 and mount near the rear of the enclosure. Three mounting holes in the board match the mounting bosses molded onto the enclosure's bottom half. Prior to mounting, solder the transformer leads and 6-inch leads to all the outputs. Those leads can be cut to length later. Mount the transformer about an inch away from the power-supply section, leaving room for a line cord and fuseholder to pass through the plastic rear panel. If a three-conductor line cord is used, connect the ground wire to a closed-loop connector and connect it to the transformer mounting screw.

The type of capacitor, C93, used in the peak-hold circuit is critical, and must be a low-leakage type. Only a polystyrene or a polypropylene dielectric capacitor, rated .0033 μF to .005 μF , should be used in this application. The prototype uses a .0047 μF capacitor. You should also use a type 2N4401 transistor for Q11. Substituting an equivalent component for that transistor will cause unusual almost-peak-hold effects. Play it safe and use only recommended components.

All IC's, except IC5, use DIP sockets. Solder all DIP sockets, resistors and capacitors to the

main PC board according to Fig. 12. The following instructions will prepare the board for connection of the display and six marker LED's.

Cut away that portion of the board where the word "CUT" indicates so that the display may be recessed. Cut precisely up to the thirteen foil fingers that must mate with the connections on the display.

Three foil fingers are reserved for hookup wire to be looped through two pads. Press those

three wires flat against their fingers and let them extend one-sixteenth inch beyond the board. Solder along the length of the fingers. Use the extending wire ends as indexing pins to mate with the holes in the display. Hold the display at a right angle to the board and form solder bridges between board and display to connect all fingers.

Hold the PC board with the display along the inside of the front panel to determine where the cut-out for the display should be. Mark points where each of the six LED's must insert through the panel to be soldered to the wide fingers along the board's edge.

Use low-current, high-efficiency LED's or the CMOS circuitry will not be able to light them. Drill holes for the LED's with a number 33 or $\frac{7}{64}$ -inch bit. Lay out the rest of the panel and cut all other necessary holes.

Make an "L"-shaped metal bracket to help hold the board in place before the LED's are inserted through the front panel and soldered in place. The letters L and S are etched on the board to indicate long and short leads from the LED's. The cathode is the short lead of the LED.

Attach the metal supporting bracket to the board with a 4-40 machine screw. A hole is provided between IC11 and IC12. Connect the other end of the bracket to the front panel and solder the LED's for additional support.

Add front-panel controls which are closest to the board first, and then complete the connections to the board. It is easier to bring the leads from the controls to the foil side rather than insert them through holes from the component side.

The 8 volts peak-to-peak SWEEP output from the sweep/generator may be too much for some scopes to adequately handle. If that is the case, a voltage divider may be needed. A voltage divider can be made by soldering resistors to the SWEEP jack terminal. Solder a 1K resistor from the positive ter-

AUDIO SWEEP/MARKER GENERATOR

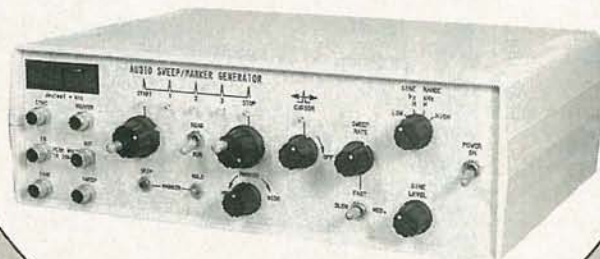

JOHN WANNAMAKER

Build this sweep/marker generator and discover the audio-range frequency response of your amplifier or filter design.

minimal to ground and a 4.7K resistor in series with the lead wire to the PC board.

A long jumper wire must be added to the board to make the connection between the counter input and one end of C16. Solder the leads from the power-supply board to the main board. Complete the connections to the ON/OFF switch and insert a 0.5-amp fuse. Don't forget to drill a hole in the top enclosure, directly above R9, so that a trimming tool can be inserted after the enclosure is assembled.

Now it's time to install the IC's on the main board. The IC's are inserted in DIP sockets, and certain waveforms are monitored at test points in a sequence of stages. That way all circuits and components are properly adjusted before proceeding to the next step. Check the power-supply voltages before any IC's are installed. The right most pin of each voltage regulator chip is the output. When checked with a scope, any ripple should be less than 1 millivolt. Make sure you unplug the power-supply cord before proceeding to each subsequent step.

Insert IC17, IC18, and IC19 in the counter area and turn the power on. The on-board LED near the crystal should blink dimly at either 1- or .1-second intervals depending on the position of the SINE RANGE switch. If it does not blink, turn off the power and interchange IC17 and IC18. Troubleshoot the IC by checking the voltage on the appropriate pins first. If an IC is installed backwards and power is applied, the IC may be damaged.

When the LED blinks properly, the frequency display should dimly indicate 0000. The decimal will probably not be visible in any position of the SINE RANGE switch.

Clip a jumper lead from either end of any 10-ohm resistor in the power supply to the side of R26 closest to potentiometer R28. Turn the power on. The readout should be 0060, ± 1 Hz, on the two lowest positions of the SINE RANGE switch. There may be an occasional erratic readout such as 0067. On the two higher positions of the switch, the readout should be 0006 or 0007.

Insert IC14 and IC15 and keep the jumper between the power

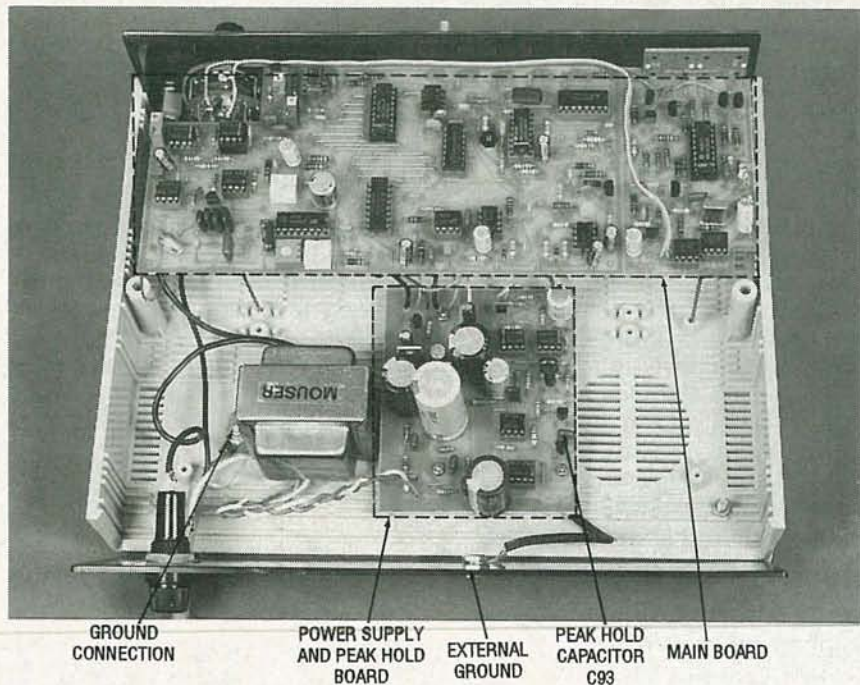

FIG. 10—INTERNAL VIEW OF MARKER/SWEEP GENERATOR.

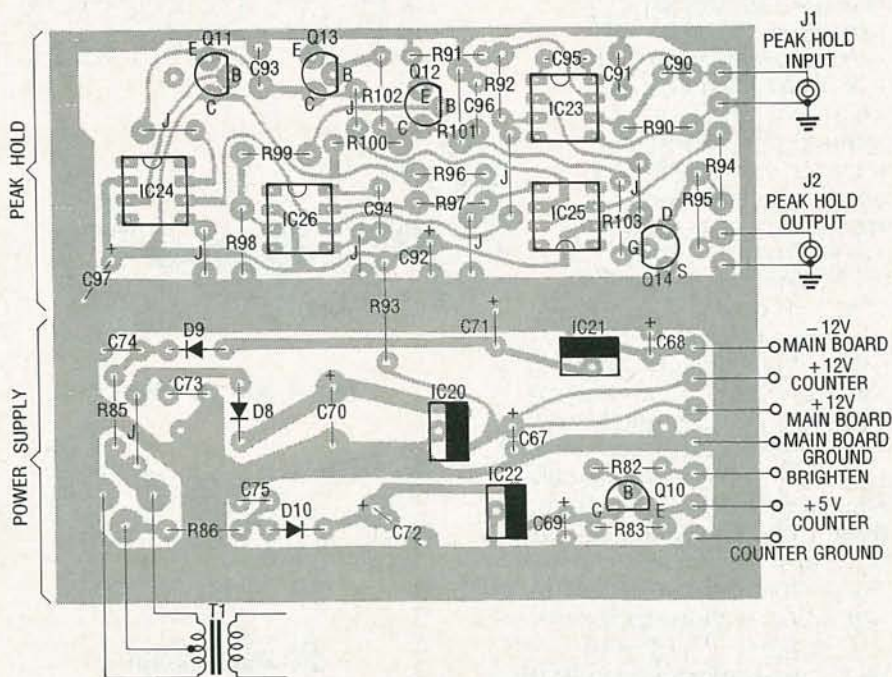

FIG. 11—PARTS PLACEMENT DIAGRAM OF THE PEAK-HOLD and power supply board.

supply and R26 in place. Turn the power on. Select the lowest position of the SINE RANGE switch, then select the READ mode. Short pin 2 of IC14 to ground with one quick momentary touch. After three seconds the display should brighten and be easy to read. Select either of the two highest positions of the SINE RANGE switch. The decimal should be visible between the two middle digits. Set the SWEEP RATE switch to slow before proceeding.

Insert IC1 into the PC board. Disconnect only that end of the jumper that goes to the 10-ohm resistor in the power supply and connect it to either end of R2 (R2 is jumped to R26). Select the lowest position of the SINE RANGE switch and turn the power on. The counter should display the frequency of the pulses generated by IC1. Sample the three positions of the SWEEP RATE toggle switch and vary the SWEEP RATE adjustment. You should see the

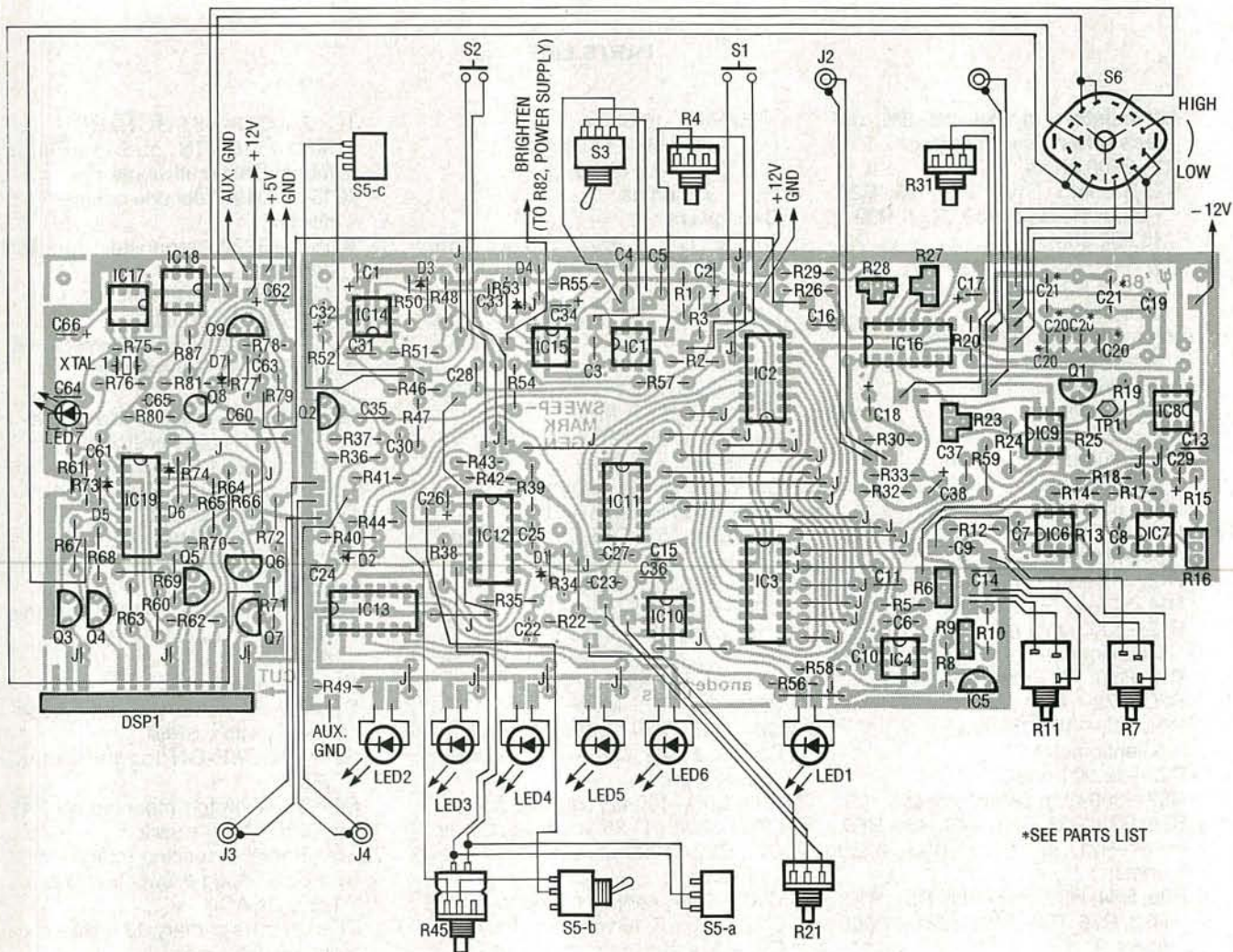
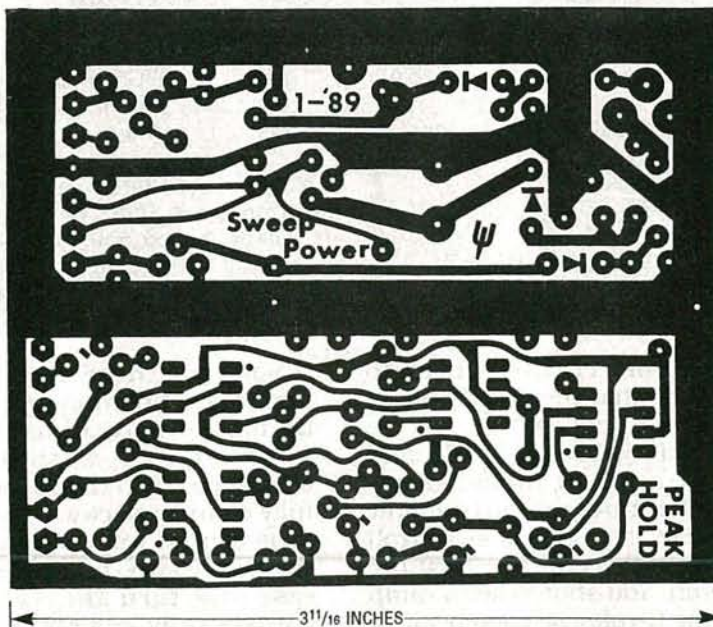

FIG. 12—PARTS PLACEMENT DIAGRAM OF THE MAIN BOARD.



THIS IS THE FOIL PATTERN for the power-supply and peak-hold PC board.

frequency vary from about 160 Hz to more than 80 kHz. Select a

high position of the SINE RANGE switch to read any value above

9999 Hz. There may be small frequency gaps where the three ranges do not overlap. If the jumper wire is connected to the side of R2 closest to the DIP socket for IC2, the HOLD button may be pressed and held to reset the count to 0000. If troubleshooting must be done, pulses varying from zero to +11 volts should be seen at the end of R2 nearest IC1. The checkout waveform is shown in Fig. 13-a.

Remove the jumper wire between R2 and R26. Insert IC2, IC3, and IC4. Select the FAST position of the SWEEP RATE switch (middle position) and set the SWEEP RATE adjustment to the middle position. Turn the power on. Adjust the scope for DC input, 1 volt per division, and either 20 or 50 milliseconds per division. You should observe a linear ramp varying from near 0 to about 4.5 volts at either end of R58, between IC3 and IC4. That waveform is shown in Fig. 13-b.

PARTS LIST

All resistors are ¼-watt, 5%, unless otherwise indicated.

R1—3900 ohms
 R2, R5, R15, R19, R24, R25, R26, R39, R41, R58, R59, R77, R99—10,000 ohms
 R3, R47—3300 ohms
 R4, R28, R31—50,000-ohm potentiometer
 R6—10,000-ohm multiturn potentiometer
 R7—2000-ohm 10-turn potentiometer
 R8—2200 ohms
 R9—2000-ohm multiturn potentiometer
 R10—6800 ohms
 R11—10,000-ohm 10-turn potentiometer
 R12, R13—1 megohm, 1%
 R14, R17—47,000 ohms, 1%
 R16—5000-ohm multiturn potentiometer
 R18, R80, R90—100,000 ohms
 R20, R79—1000 ohms
 R21, R23—10,000-ohm potentiometer
 R22—12,000 ohms
 R27—500-ohm potentiometer
 R29, R32, R33, R36, R49, R54, R56, R67—R71, R92, R102, R103—4700 ohms
 R30, R34, R38, R48, R50, R51, R53, R73, R76, R78, R81, R82—47,000 ohms
 R35, R40—68,000 ohms
 R37—15,000 ohms
 R42—1.5 megohms
 R43, R83, R87—150 ohms
 R44, R46, R91, R100, R101—1500 ohms
 R45—50,000-ohm potentiometer with SPST switch
 R52—270,000 ohms
 R55—4.7 megohms
 R60—R66, R94, R95—100 ohms
 R72—68 ohms
 R74—1 megohm
 R75—10 megohms

R85, R86—10 ohms
 R84, R87—R89—unused
 R93, R97—4.7 ohms
 R98—330 ohms
Capacitors
 C1, C2, C17, C26, C29, C32, C66, C68, C69—10 µF, 25 volts, electrolytic
 C3, C6, C7, C15, C30, C31, C36, C37, C65, C91, C94—0.001 µF, Mylar
 C5, C9, C11, C14, C23, C28, C33, C61—0.01 µF, Mylar
 C4, C13, C16, C25, C60, C73, C74, C75—0.1 µF, Mylar
 C8, C64—22 pF, ceramic disc
 C10—470 pF, ceramic disc
 C12, C39—C59, C76—C89—unused
 C18—100 µF, electrolytic
 C19—.0068 µF, Mylar
 C20—0.004 µF (four 0.001 µF 1% capacitors in parallel), Mylar
 C21—0.8 µF (0.33µF and 0.47µF wired in parallel), Mylar
 C22—0.033 µF, Mylar
 C24, C27, C35—0.005 µF, Mylar
 C34, C38, C62, C67—47 µF, 16 volts, electrolytic
 C63, C95—100 pF, ceramic disc
 C70—3300 µF, 25 volts, electrolytic
 C71, C72—1000 µF, 25 volts, electrolytic
 C90—10 µF nonpolar, electrolytic
 C92—470 µF, 16 volts, electrolytic
 C93—see text
 C95—47 pF, ceramic disc
 C96—0.05 µF, Mylar
 C97—2200 µF, electrolytic
Semiconductors
 IC1, IC14, IC15—XRL555 timer
 IC2—CD4040, 12-stage binary ripple counter
 IC3—DAC1222LCN D/A converter
 IC4, IC6, IC7, IC8, IC9, IC23—IC25—CA3140E op-amp
 IC5—LM336Z 2.5-volt reference diode
 IC10, IC26—CA3130E op-amp
 IC11—CD4068 8-input NAND gate

IC12—CD4538BCN/BCP or MM14538BCN dual-precision monostable multivibrator
 IC13—CD4017 decade counter/divider
 IC16—XR2206 monolithic function generator
 IC17, IC18—RDD104 timebase
 IC19—74C926 counter
 IC20—7812 12-volt positive regulator
 IC21—7912 12-volt negative regulator
 IC22—7805, 5-volt positive regulator
 Q1—Q13—2N4401 transistor
 Q14—2N2219 transistor or VN0300M MOSFET (see text)
 D1—D7—1N914 diode
 D8, D9, D10—1N4001 diode
 DSP1—NSB3881, 4-digit, 7-segment LED display
 LED1-7—LN28CAL(US) Panasonic high-efficiency light emitting diodes

Other components

S1, S2—momentary contact push-button switch, SPST
 S3—ON-OFF-ON toggle switch, SPDT
 S4—SPST switch mounted on R45
 S5—3PDT toggle switch
 S6—3-pole, 4-position rotary switch
 S7—SPST toggle switch, 1.0 amp, 125 volts AC
 T1—120 volts primary, 12.6 volts secondary, 0.6 amps
 J1—J6—RCA chassis mount phono jacks
 XTAL1—5-MHz crystal
 F1—0.5-amp fuse
Miscellaneous: Fuseholder, 3-conductor 18 AWG line cord, Jameco enclosure type H2507, DIP sockets and hardware.

Note: A set of 2 PC boards is available from John Wannamaker, Route 4, Box 550, Orangeburg, S.C. 29115: \$43.00, postage paid, S.C. residents add 5% sales tax.

The falling edge of the ramp may appear to have 6 to 10 short steps as it descends. The SWEEP RATE adjustment should vary the ramp's duration from about 40 milliseconds to 280 milliseconds. If there is a problem with the ramp's amplitude or duration, check pins 4 through 15 of IC3. You should observe a 12-volt square wave at each pin. Start at pin 15 and work in descending order to pin 3 and note that the square wave duration doubles at each pin. Proceed only when the

ramp is correct, then check to make sure that the middle pin of IC5 is +2.5 volts DC.

Insert IC5, IC6, IC7, IC8 and IC9 into the board. Adjust the on-board trimmer potentiometer R23 (the SWEEP BALANCE control) to the middle position. Turn the power on. You should see a ramp of about 8-volts peak-to-peak at the SWEEP output jack, J1. That waveform is shown in Fig. 13-c. Now adjust R23 for a true AC ramp with an equal positive and negative distribution.

Some of these next adjustments are preliminary, and will be more finely adjusted later. Look at TP1 with the oscilloscope. Turn the START control fully counter clockwise, with the STOP control fully clockwise. Set the SWEEP RATE toggle switch to FAST and turn the SWEEP RATE control fully clockwise for the fastest sweep possible. Preset the on-board multiturn potentiometers R6, R9, and R16 fully clockwise. Turn the power on and adjust R16 clockwise until a

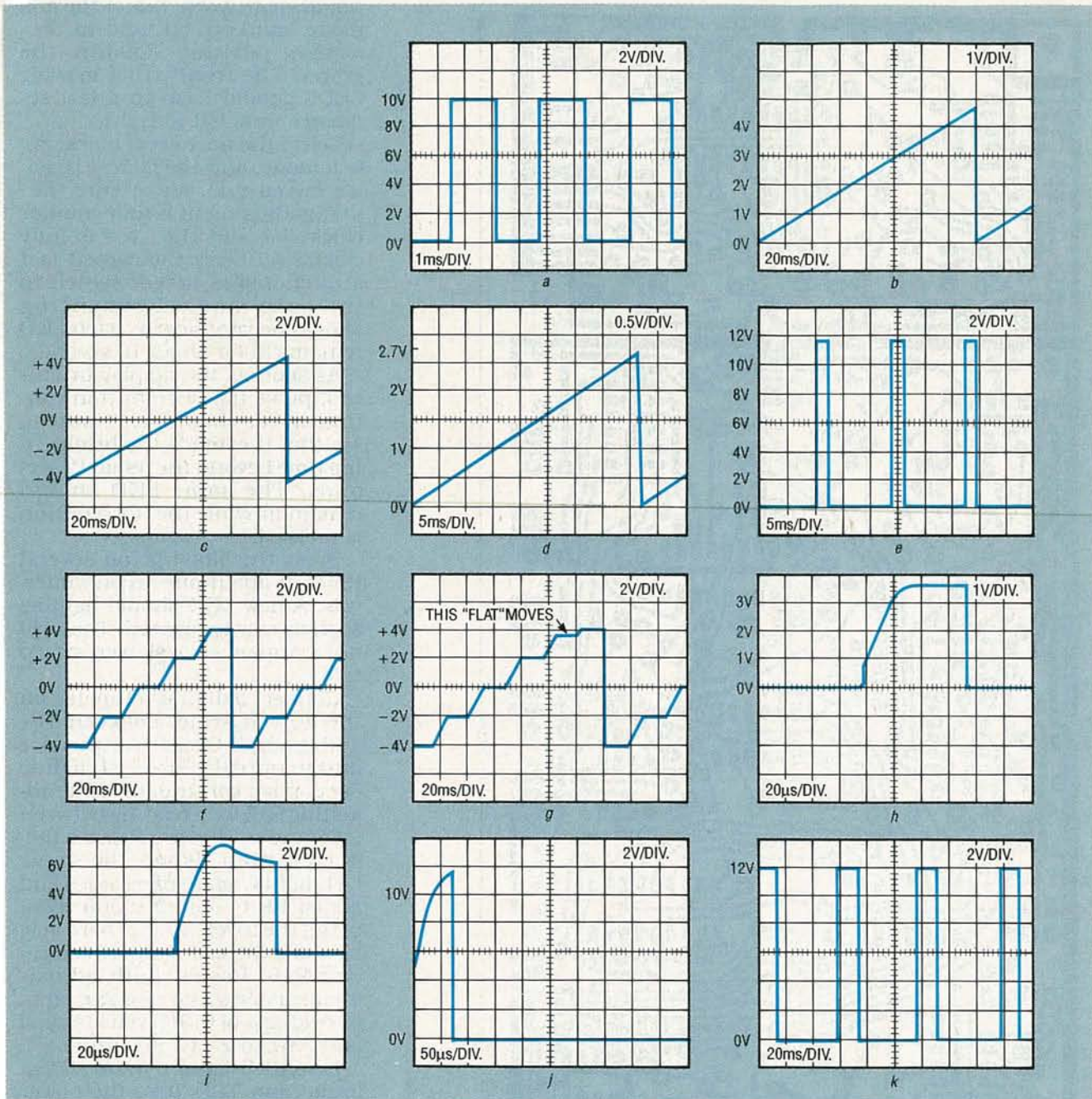

FIG. 13—CHECKOUT WAVEFORMS: (a) shows pulses at the end of R2 closest to IC2, SWEEP RATE ON LOW and adjusted to mid-range; (b) shows a ramp at either end of R58, SWEEP RATE ON FAST and adjusted to mid-range; (c) shows an AC ramp at jack J1, SWEEP RATE ON FAST and adjusted to mid-range; (d) shows a saw-tooth ramp, at TP1, adjusted for 0 to 2.7 volts, SWEEP RATE ON FAST and adjusted fully clockwise; (e) shows a ramp at pin 13 of IC11 adjusted to fill the CRT; (f) shows a sweep with marker flats at J1, SWEEP RATE ON FAST and adjusted fully clockwise; (g) shows a sweep with markers and cursor at J1, SWEEP RATE ON FAST and adjusted fully clockwise; (h) shows the peak-hold output at 6.3 kHz; (i) shows the peak-hold output overdriven at 6.3 kHz; (j) shows the sync pulse at J3, SWEEP RATE ON FAST and adjusted for mid-range and (k) shows markers at J4, synchronize the scope with SYNC, J3, SWEEP RATE ON FAST and adjusted to mid-range.

ramp-like waveform appears. Continue adjusting R16 until the positive peak is no more than +2.70 volts, as shown in the Fig. 13-d waveform. The positive peak may be flattened. The lower portion of the ramp may become flattened as the adjustment is made.

Adjust R9 clockwise until any flattened lower portion of the ramp disappears and the bottom has a sharp sawtooth-like transition at the 0-volt line. Adjust R6 clockwise until any flattened upper portion of the waveform disappears and the top has a sharp sawtooth transition. Adjust the

SWEEP RATE so that one ramp spans the entire CRT graticule from left to right with the scope adjusted for 5 milliseconds per division in preparation for the next step.

Insert IC11 and turn the power on. A positive 12 volts should be present at pin 13 of IC11 with four spike-like pulses that fall to zero during each ramp cycle. That waveform is shown in Fig. 13-e. The scope may show five such pulses, as one will be the first spike of a new cycle.

Insert IC12 and IC13. Make sure you use a 4538 IC with a BCN or BCP suffix, as others are

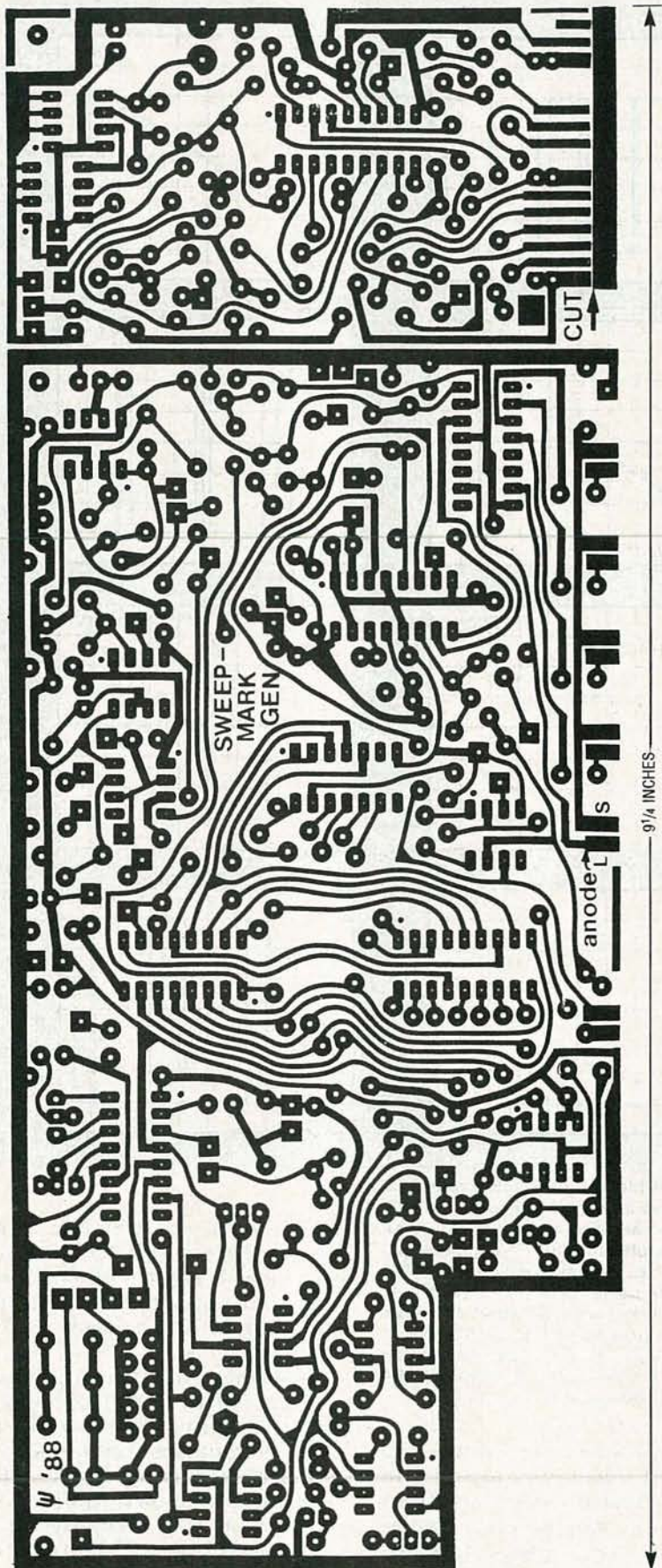

THIS IS THE FOIL PATTERN for the main PC board.

not likely to work. Select the RUN mode, markers on, and in the NARROW position. Restore the power. The front-panel marker LED's should flash in a fast sequence from left to right.

Select the narrowest markers, RUN mode, and the fastest possible sweep rate. Make sure the START adjustment is fully counter clockwise and the STOP is fully clockwise. Once the correct fast sequencing is noted, switch to the READ mode. Sequencing should be very slow as each LED remains lit for about 15 seconds.

As soon as the display brightens, press the HOLD button continually for about one minute to see that it extends the brightening time beyond the usual 12 seconds. The same LED should remain lit while the HOLD button is pressed.

Press the SKIP button several times at about one second intervals. A new LED should light as soon as SKIP is pressed. That will not happen at a slower sweep rate.

Connect a digital voltmeter, on the 20-volt scale, between TP1 and ground. Cycle with the SKIP button until the STOP LED lights. Press HOLD continually while adjusting R16 for a reading between 2.67 and 2.71 volts. Release the HOLD button. When the START LED lights, again press HOLD and adjust R9 to obtain 0.006 volts, using the 2-volt scale. There may be some interaction between R9 and R16. Repeat both adjustments as necessary for the proper readings of 0.006 volts (START) and 2.67 to 2.71 volts (STOP).

Insert IC16 and remove all test leads from TP1. Turn the power on. Make sure the START adjustment is fully counter clockwise and the STOP is fully clockwise. Select the frequency readout position in the middle range of SINE RANGE. Select the FAST SWEEP RATE. Cycle for the START LED to light and press the HOLD button. Retrim R9 for a frequency readout between 0030 and 0035. Release the HOLD button. Resistor R9 may need adjustment from time to time, due to frequency drift.

Select the kilohertz readout position in the middle range of SINE RANGE. Cycle until the STOP LED lights. Press the HOLD button. If the readout is between 20.10 and

OPERATING INSTRUCTIONS

1. Plug the marker/sweep generator in and turn the power on. Allow one half to one full hour of warm-up time in the RUN mode to minimize frequency drift.

2. Select the FAST position of the SWEEP RATE switch, and select the READ mode.

3. Select the proper frequency range with the SINE RANGE switch. The low range is from 3 Hz to 1 kHz. Both medium positions (M) cover the same range of 35 Hz to 20 kHz. The frequency display will be in Hz or kHz depending on which (M) position is selected. The high frequency range is 3 kHz to 100 kHz.

4. Wait until the unit automatically cycles so that the start LED is lit, or manually cycle by pressing the SKIP button.

5. When the START LED lights and the frequency readout brightens, press the HOLD button continuously while adjusting the START frequency. When the START frequency control is fully counter clockwise, with the middle (M) Hz range selected, the frequency readout should be between 0030 and 0035 Hz. If it is not, adjust potentiometer R9 through the hole in the top of the enclosure. Now, adjust the START frequency as desired.

6. Manually cycle the LED's with the SKIP button until the STOP LED is lit. When the frequency readout brightens, press HOLD and adjust to the desired STOP frequency.

7. The START and STOP frequencies interact somewhat. Repeat both adjustments once, adjusting the START first and STOP last.

8. Connect the SWEEP output of the generator to the X input of the scope. Connect the SINE output of the generator to the Y input of the scope. Turn the SINE level down counter clockwise. Select the FAST SWEEP RATE, RUN mode and NARROW MARKERS. The CURSOR should be fully clockwise.

9. Adjust the scope for X-Y operation. A horizontal line with five equally spaced dots, or bright spots, should be seen. Adjust the scope's X gain and positioning so that the line-ends, with bright spots at each end, exactly match the left and right CRT graticule lines.

10. Adjust the SINE LEVEL control for the desired peak-to-peak output voltage de-

21.20, no adjustment is necessary. If the readout is only off slightly, adjust R6 and R16 just a little. Recheck to see that the low end still has a frequency reading of 0030 to 0035 Hz. Three potentiometers, R6, R9, and R16, all interact, and if a little adjustment cannot correct for proper readouts, all the steps after inserting IC6-IC9 may have to be repeated. If the .04 μF timing capacitor, C20 (four .01 μF 's in

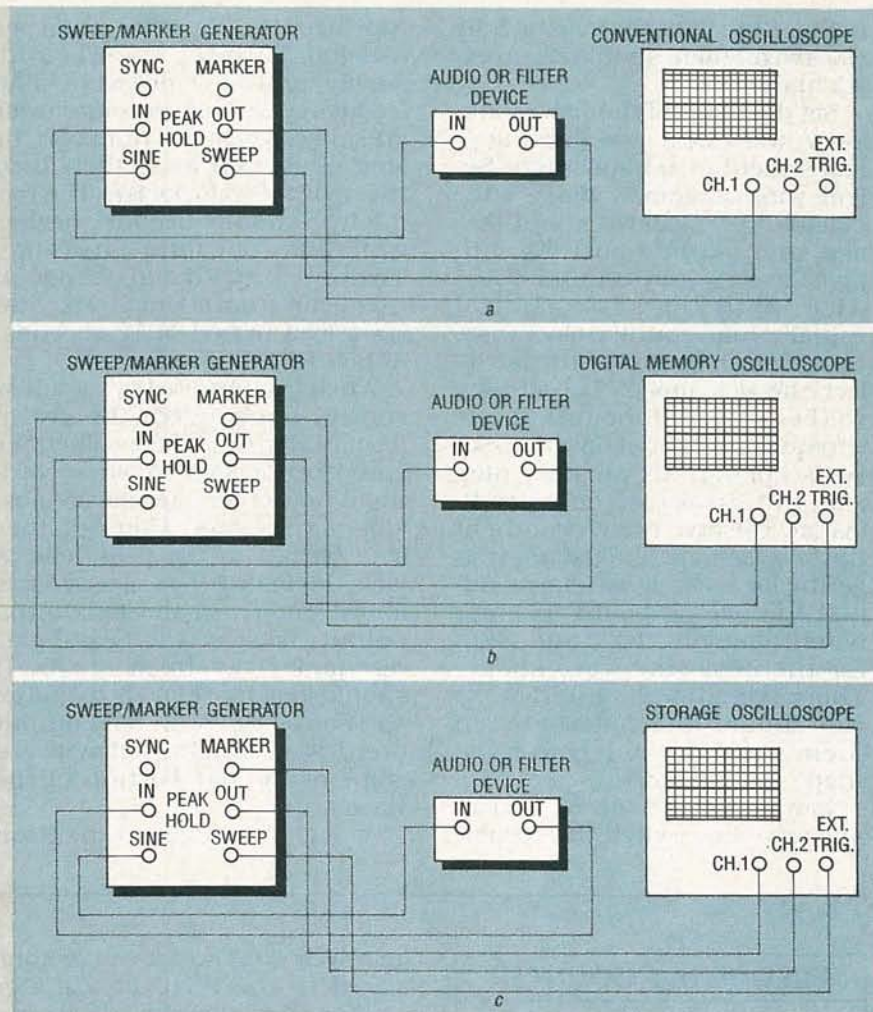

THESE ARE SWEEP/GENERATOR CONNECTIONS for a conventional, digital-memory or a storage scope.

sired. A MEDIUM OR SLOW position of the SWEEP RATE control may be more convenient to use when adjusting the amplitude.

11. Disconnect the cable from the SINE jack and connect it to the peak-hold OUT (the peak-hold OUT connects to the scope's Y input.)

12. Connect the SINE output of the generator to the input of the device to be tested. Connect the device's output into the peak-hold IN of the generator.

13. Adjust the SWEEP RATE, switch, and control for the desired sweep rate.

14. Adjust the scope's volts/division control (Y input) as required.

15. The scope's brightness should be turned down for a satisfactory contour-line display of the response curve. The peak-hold will not operate properly with an input signal of more than 3.75 volts peak-to-peak. Inputs of 0.2 volts to 3.75 volts work best.

parallel), is not within 1 percent, you may have to find your own adjustment values, or settle for a slightly different range span.

The low and high ranges of the SINE RANGE have no separate adjustment; only the timing capacitors C19 and C21 can change their ranges. Extra space is provided on the PC board for paralleling capacitors in order to find a proper range more easily.

Insert IC10, a CA3130E, and

turn the power on. Select the RUN mode with a fast sweep, MARKER on NARROW and CURSOR turned fully clockwise. With the scope on DC input, observe the SWEEP waveform at J1. A ramp waveform interrupted with five flats, or markers, should be seen as in Fig. 13-f. Adjust the CURSOR control slowly counter clockwise and observe an additional flat moving smoothly among the others. That waveform is shown

in Fig. 13-g. With the CURSOR fully clockwise, there should be no extra marker.

Set the range of the SINE RANGE, SLOW SWEEP RATE, and SWEEP RATE adjustment at mid-position. Select WIDE MARKERS, place the CURSOR fully clockwise, and the SINE LEVEL at mid-position. Adjust the STOP fully counter clockwise. With the START control initially fully counter clockwise, turn it clockwise three turns. Select the RUN mode. The display will be dim, but it should indicate a frequency of about 6500 Hz. Set the scope for 0.5 volts per division and 20 microseconds per division. Observe the waveform at the SINE jack, J2, and adjust triggering for a steady waveform. Adjust the two on-board trimmer potentiometers, R27 and R28, for the best sine-wave shape. Those adjustments interact, so you should alternate between them until a good sine-wave shape is achieved.

Now, remain triggered on the sine wave but switch the scope's

time base to 0.2 milliseconds per division. Turn the START control slowly counter clockwise. The frequency should become lower and may drop to less than 1 Hz, or stop oscillation altogether. Turn the STOP fully clockwise. The frequency should become higher while the STOP control is turning. The waveform should change in frequency from about 30 Hz to 20 Hz over a period of 12 seconds. Adjust R16 if necessary.

When the SWEEP RATE switch or control is changed, the sweep from 30 Hz to 20 kHz will either speed up or slow down accordingly. Adjust for the slowest possible SWEEP RATE. Connect the SINE output to the peak-hold in jack, J6. Reduce the SINE LEVEL to about one-third the maximum output. Look at the peak-hold OUT jack, waveform at J5. It should look like Fig. 13-h. Figure 13-i shows the peak-hold output overdriven, causing a downward slope of the flat portion of the waveform.

A +11-volt synchronization

pulse should be seen at the SYNC jack, J3, as shown in Fig. 13-j. The pulse will have an RC time constant-like rise and a fast fall, with a duration of about 70 microseconds. Use the fastest possible SWEEP RATE. Set the scope for 2 volts per division, 50 microseconds per division, and use (+) slope triggering.

To observe the output at the MARKER jack, J4, select the RUN mode, SWEEP RATE switch set to FAST, SWEEP RATE adjustment to mid-position and the markers set on and NARROW. Synchronize the scope with the output of the SYNC jack, J3. Adjust the scope's triggering for external input, (-) slope triggering, and use a 20 millisecond per division sweep rate. Four markers, consisting of positive pulses, should be seen with a peak value of 12 volts, and a duration of about 15 milliseconds each. That waveform is shown in Fig. 13-k. The MARKER control should increase the pulsewidth. That completes the checkout. **R-E**

FREQUENCY COUNTER

continued from page 54

corner facing the RF section. Place and solder the remaining IC sockets and all other components. Bolt the bracket to the DB25 connector using #4 hardware. Mount the BNC-cable assembly to the bracket with the solder lug soldered to the back of the PC board. After checking all solder connections, place the IC's in their sockets.

Figure 9 shows an actual-size template for a brass RF shield that goes over the surface-mount portion of the PC10 board. The material should be 0.005-inch brass shim stock. Simply cut out the template (or photocopy it), and tape it on top of the brass stock. Cut along the solid lines using shears, and score along the dotted lines with an exacto knife. Bend down on the score lines and solder the shield in place over the surface-mount section of the board as shown in Fig. 10. Check the operation of the RF amplifiers before installing the brass shield. The AP10H amplifier board is

relatively easy to assemble compared to the PC10 board. The only surface-mount parts are two MMIC amplifiers that are installed as before. Figure 11 shows the parts-placement diagram for the AP10H board. The completed board must be installed in a suitable enclosure. Figure 12 shows the completed unit.

Alignment and calibration

Mechanical adjustment of the 10-MHz timebase is provided by trimmer C9. One of the unique features of the PC10 is the software calibration which is available when the program is running. It is really not necessary

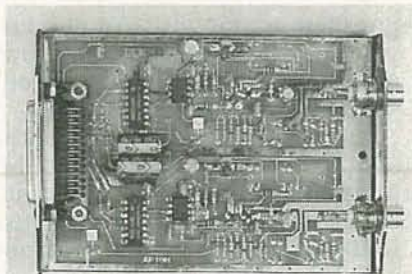

FIG. 12—THE FINISHED AP10H BOARD. The enclosure is available from the source mentioned in the parts list.

to adjust C9 unless you have a desire to. Resistor R31 is the input-bias adjustment which can be set to the 4:00 position.

The two bias adjustment trimmers in the AP10H amplifier should be set for maximum sensitivity when counting a low-level signal. They can be initially set for mid-range.

Installation

The PC10 will work in any computer that has Windows 3.0 installed, and it requires one three-quarter length expansion slot.

Copy the supplied software to your Hard Disk (you may wish to create a PC10 directory). While in Windows, select the Program Manager and click options under Windows Setup, Options, and Set Up Applications. Follow the instructions to locate and set up the program COUNTER.EXE as a Windows application. To run the PC10 counter, simply select the Counter.exe logo using the mouse and give it a double click.

The actual counter input sensitivity will vary somewhat depending upon the host computer. Grounding, shielding and placement influence performance. **R-E**

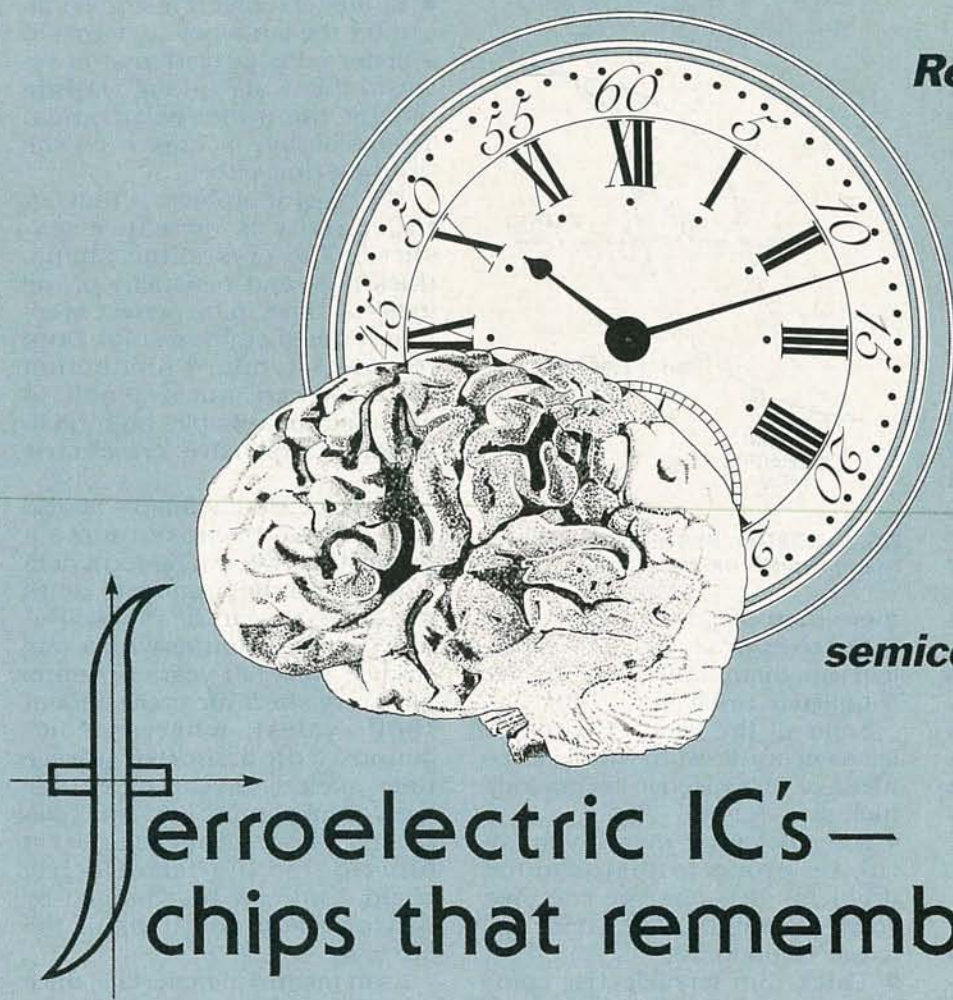

**Recent breakthroughs
in ferroelectronics
technology promise
nearly "ideal"
nonvolatile
semiconductor memories.**

TJ BYERS

Ferroelectric IC's — chips that remember

WHAT HAPPENS TO VOLATILE ELECTRONIC information when the lights go out? Usually it vanishes into thin air, never to be found again. But an old technology with new advancements may make lost data a thing of the past.

Ferroelectric technology has long tantalized circuit designers by promising an easy and inexpensive way of preserving data. Although it's been a long time coming, nonvolatile semiconductor memory using ferroelectric materials that store binary information can now be made for only pennies more than an equivalent dynamic RAM IC and considerably less than an equivalent static RAM IC.

Two leading manufacturers in the ferroelectric field, National Semiconductor and Ramtron

Corp., have developed several ferroelectric semiconductor devices that retain their memory for up to a year without the aid of an external or internal auxiliary power source. Moreover, the devices are exact replacements for popular TTL and CMOS logic IC's, which means that no circuit design changes are required. It's a simple matter of out with the old chip and in with the new.

Ferroelectric devices are considered to be nearly "ideal" because of such characteristics as:

- Total immunity to power failure.
- Resistance to radiation.
- Symmetrical read and write cycles.
- Low power consumption.
- Most operate from a single +5 volt power supply.

We will take a look at how fer-

roelectric technology has overcome its traditional problems to become a viable solution to battery-free, nonvolatile semiconductor memory.

How ferroelectrics work

Ferroelectric technology is based on the fact that different insulating materials have different dielectric characteristics. Most of us think of a dielectric material as the stuff used in capacitors, such as polycarbonate film or mica, where the electric field, or flux density between the plates of the capacitor is a linear function of the applied voltage.

Certain materials, however, exhibit nonlinear dielectric characteristics, and a few of those leave a residual polarization under the influence of an externally applied electric field. The latter are classi-

fied as ferroelectric materials. If the electric field is reversed, spontaneous polarization in the opposite direction occurs. Ferroelectric materials, therefore have two stable polarization states, which can be designed into a "bistable capacitor" with two distinct voltage thresholds.

What sets ferroelectric compounds apart from other dielectrics is a hysteresis function, or magnetic "memory," that is also characteristic of magnetic devices, such as those used in a coil or a transformer. The name ferroelectric is somewhat of a misnomer because those compounds are in no way connected with iron-based materials. The term ferroelectric was derived from their analogy to the hysteresis function of magnetic devices, which can be used to store information.

Figure 1 shows the hysteresis loop of a typical ferroelectric dielectric material. That curve is generated by placing a ferroelectric substance between two metal plates and applying a voltage. Notice that as the voltage across the material increases, a threshold point is reached where the permittivity of the dielectric suddenly changes.

Once the ferroelectric dielectric density threshold has been exceeded, a residual polarization charge remains in the dielectric even after the source voltage is removed. It is that residual polarization effect that makes the ferroelectric material effective as a data storage device because the only way to change its state is to apply a reverse voltage across the ferroelectric material of sufficient strength to reverse the polarity of the ferroelectric charge.

Because no external electric field is needed for the ferroelectric material to remain polarized in either state, a true nonvolatile digital memory capacitor can be designed for storing logical "1's" and "0's," according to the polarization state of the material. The stored information can be written to or read from a ferroelectric cell by applying an electric field greater than the threshold (coercive) field to each memory element.

Although the process seems simple enough in theory, it took

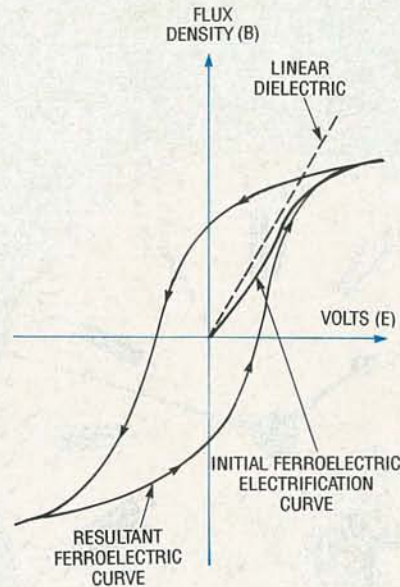

FIG. 1—NORMAL HYSTERESIS loop of a typical ferroelectric material.

more than 30 years to make ferroelectrics practical. The problems are many, and not all are yet completely resolved.

Some of the frustrating problems encountered in the development of ferroelectric technology include:

- A ferroelectric memory array can be prone to disturbance problems because the coercive voltage is not well defined for different compounds.
- Thick film ferroelectric compounds used in earlier designs required coercive voltages ranging from tens to hundreds of volts, which was far in excess of the +5 volt DC supply used in modern day microelectronics. Also, their slow switching speed made thick film ferroelectrics impractical for high-speed read/write memories (<100 ns).
- Many ferroelectric materials exhibit the phenomenon of fatigue, in which the residual po-

larization reduces as the total number of polarization reversals increases.

• Some ferroelectric materials exhibit the tendency to return to a preferred polarization after reversal following a long waiting time at the initial polarization. That reaction is known as the "waiting time effect".

The biggest problem is that ferroelectricity is structure-sensitive. The crystalline shape, thickness, and resistivity of the material have to be perfect every time for predictable results. Until recently, standard production methods were not available to manufacture reliable, high-quality and inexpensive ferroelectric IC's.

Ferroelectric chemistry is also very critical because there's a trade-off between long-term data storage and the number of times the dielectric can be cycled. Ferroelectric compounds with a long storage time (10 years or more) have very short life cycles (about 1000 cycles), whereas compounds with a shorter storage time, such as a year, have a life span that approaches a trillion cycles. Those properties are a function of the ferroelectric blend, and can be changed by varying the proportions of the mixture.

As in magnetic materials, once a ferroelectric material reaches a certain temperature, its residual polarization cannot be maintained, and thus its ferroelectric effects are lost. The temperature above which ferroelectric effects disappear is known as the Curie temperature. Upon cooling, the ferroelectric effect returns, but the data is lost forever. Unfortunately, most ferroelectric materials have a Curie temperature that's below the boiling point of

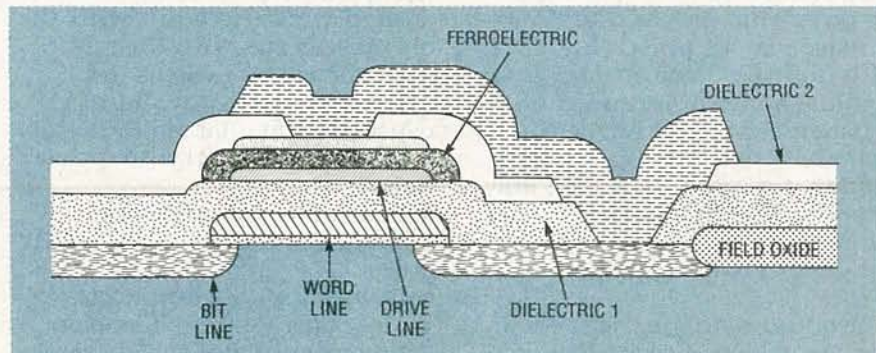

FIG. 2—INTERNAL STRUCTURE of a ferroelectric memory cell.

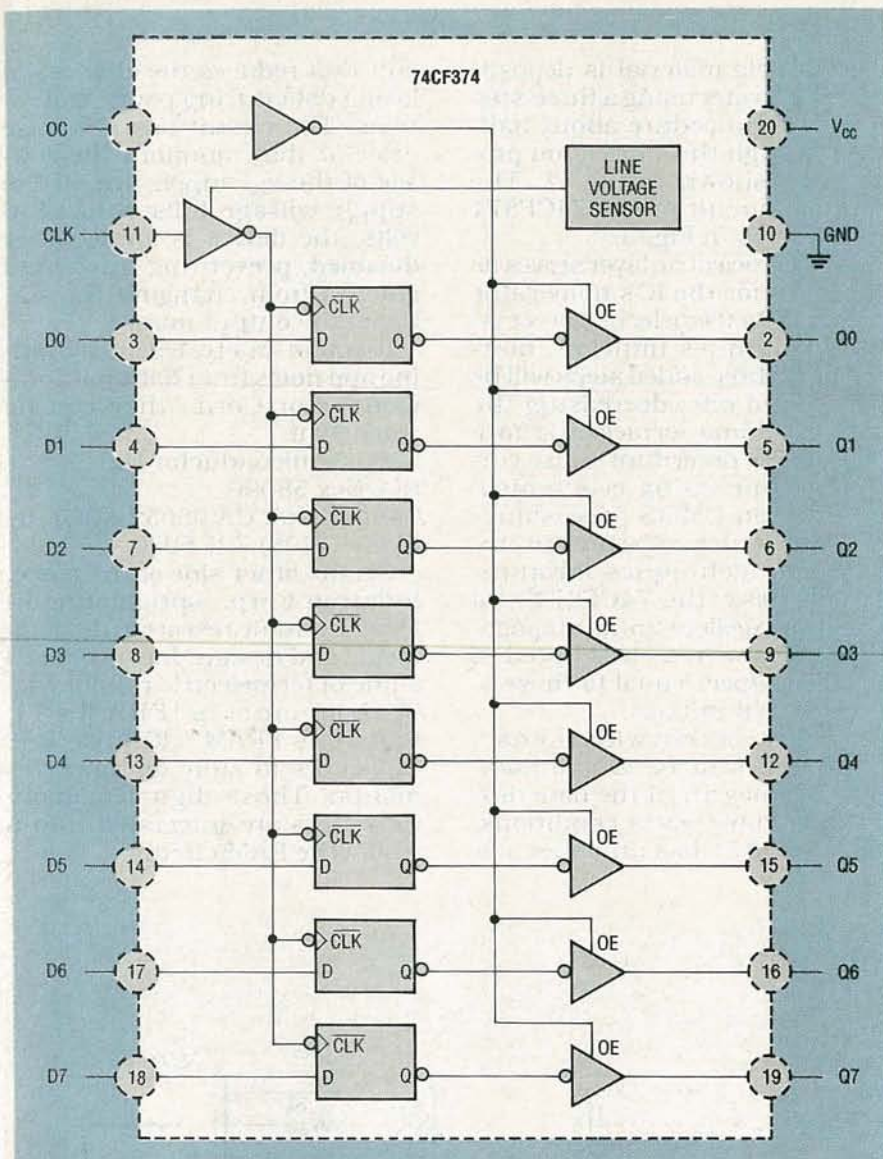

FIG. 3—LOGIC DIAGRAM of the 74CF374 IC.

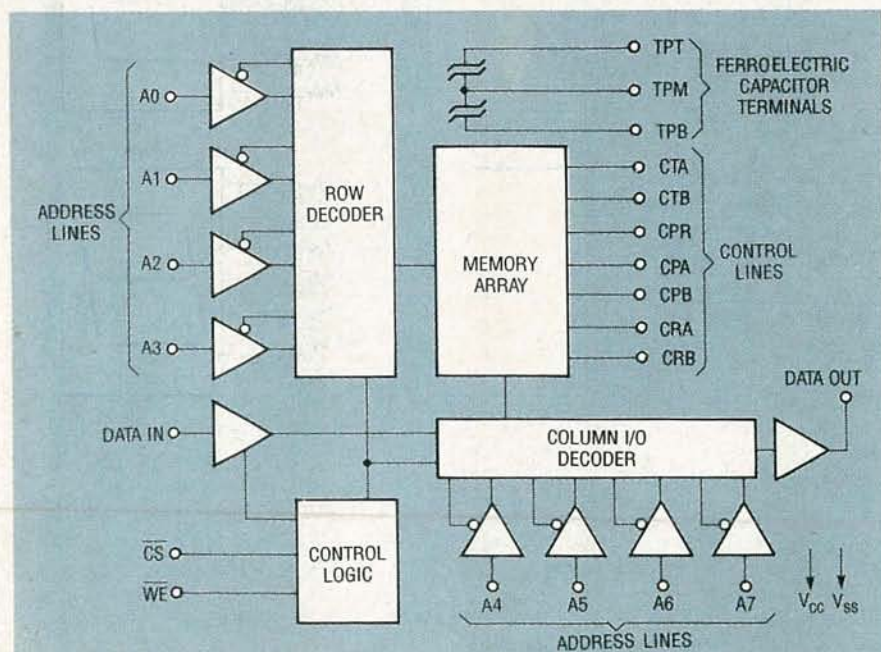

FIG. 4—FRAM's™ USE A FOUR TRANSISTOR SRAM based cell with PZT capacitors to "shadow" the RAM, thereby eliminating the traditional problem of fatigue.

water (100°C) and many require cryogenic cooling.

While there are over a hundred different types of ferroelectric materials, most are unsuitable for general use because of one or more of the reasons mentioned above. The most practical ferroelectric compounds contain lead and/or titanium because they're easily fabricated and have Curie temperatures of over 200°C.

Finally, it's ferroelectric

The first devices to roll off the National Semiconductor ferroelectric assembly line are ferroelectric versions of the 74LS374 IC, an octal D-type flip-flop with tri-state outputs. More complex devices, including a 2K static RAM IC, are working their way through National's research and development labs, and should surface soon.

The 74LS374 contains eight D-type flip-flops that behave like memory latches. The output of the flip-flops is controlled by the clock. A rising clock pulse transfers the data on the input lines to the output lines, where it remains fixed until changed by another clock pulse. The non-transparent nature of the flip-flops make this IC useful as a buffer latch in counter displays and bidirectional bus interfaces. But when the power is lost, so is the data.

In the ferroelectric version of the 74LS374, designated the 74CF374, a ferroelectric capacitor is added to the flip-flop. In normal operation, the flip-flop output follows the input with each occurrence of the clock pulse, charging and discharging the ferroelectric capacitor as the logic level changes. When the power is removed, the ferroelectric capacitor remains in the last state of operation. When power is applied to the IC, the ferroelectric cell forces the flip-flop into the last recorded state, thus preserving the data. The 74CF374's ferroelectric cells can retain data for up to a year, and the one-year clock begins again each time the data in the cells is updated through normal IC operation.

The ferroelectric material used in the fabrication of the 74CF374 is based on a perovskite crys-

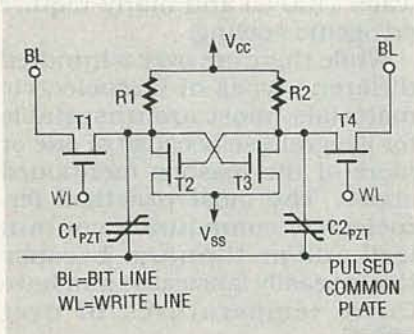

FIG. 5—A BLOCK DIAGRAM OF THE FMx 801. This device operates with equal read and write cycle times of 100 nanoseconds and is TTL and CMOS compatible at all inputs and outputs.

talline structure with a Curie temperature of about 420°C (788°F), and is a derivative of lead zirconate-titanate (PZT). Unlike previous nonvolatile alternatives, such as EEPROM's, the 74CF374 is fabricated using a process that is virtually identical to that used for standard CMOS logic and memory parts. The only deviation is that a layer of insulating

ferroelectric material is deposited on the wafer using a three-step masking procedure about half-way through the fabrication process, as shown in Fig. 2. The internal circuit of the 74CF374 IC is shown in Fig. 3.

The ferroelectric layer serves as the basis for the IC's nonvolatile memory. As ferroelectric processing techniques improve, however, the three added steps will be reduced to one, decreasing the cost of adding ferroelectric to a device. The procedure is also currently done using economical 2.0-micron CMOS processing, but that's also expected to improve as techniques advance. Nonetheless, the 74CF374 still displays excellent 25-ns propagation times with a clock speed of 30 MHz—specs equal to those of the device it mimics.

A major concern with any data protection scheme is maintaining the integrity of the data during uncertain power conditions. The 74CF374 has an added cir-

cuit that reduces the chances of losing data during power transitions. The circuit has a voltage detector that monitors the voltage of the V_{cc} supply line. If the supply voltage falls below 3.6 volts, the device is immediately disabled, preventing unwanted glitches from changing the status of the output lines.

If you're interested in obtaining app notes from National Semiconductor Corp., they can be reached at:

2900 Semiconductor Dr.

P.O. Box 58090

Santa Clara, CA 95052-8090

Phone: (408) 721-5000

On the other side of the fence, Ramtron Corp., specializing in ferroelectric research, development, and design, has produced a line of ferroelectric random access memories (FRAM's™). Ramtron's FRAM™ IC's use PZT capacitors to store digital information. Those digital memory capacitors are integrated into a read/write RAM circuit.

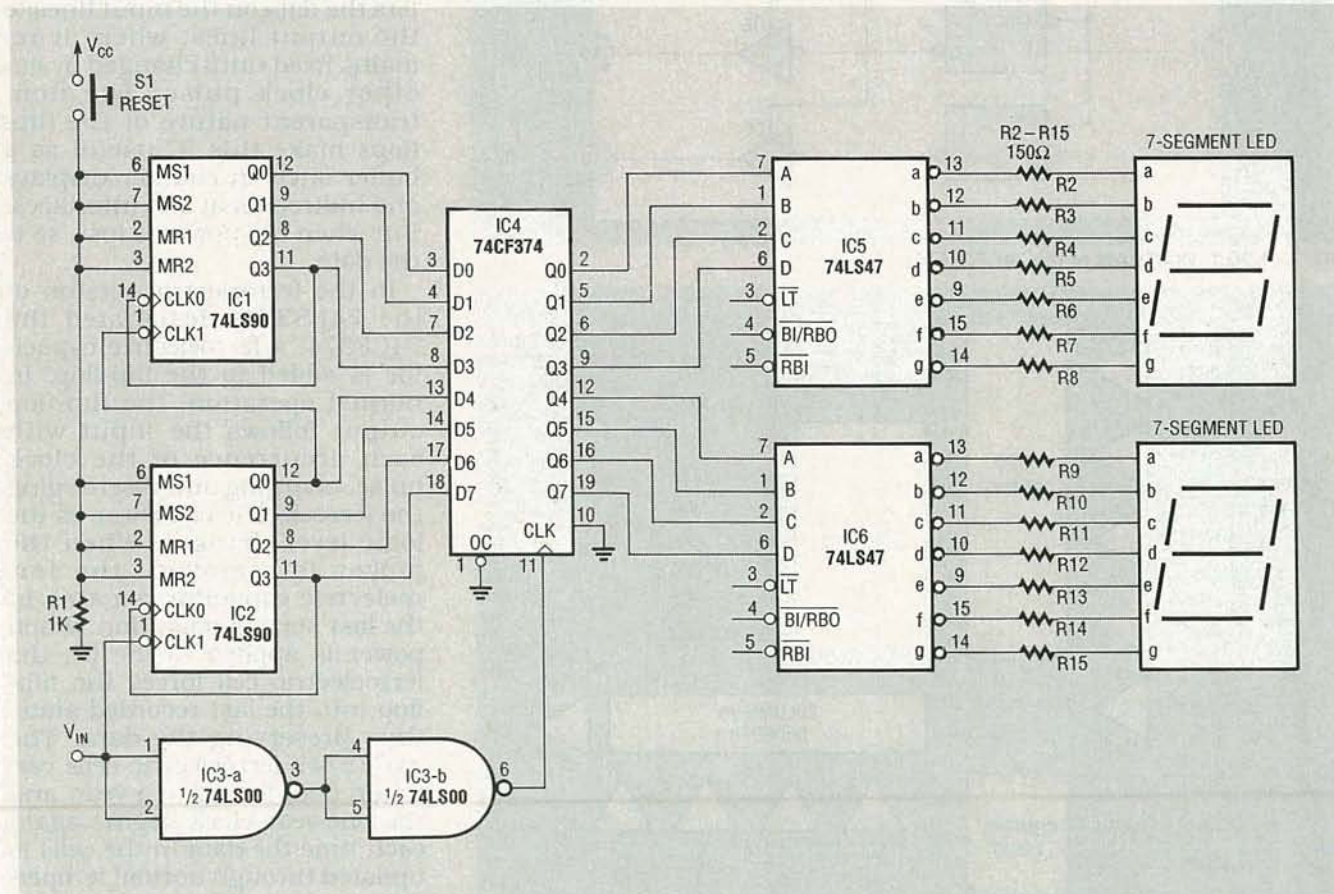

FIG. 6—THIS TWO-DIGIT event counter totalizes 5-volt input pulses, with a duration of 15 nanoseconds or longer. The advantage of this circuit is that it doesn't have to be continuously powered. If power is turned off, and then restored, the number of the last count will be displayed on the readout, similar to a mechanical counter.

Figure 4 shows a "shadow" RAM cell which uses four transistor SRAM cells interconnected with two PZT capacitors. That circuit is unique because C1 and C2 are activated to store data only when power is lost, and restores data when power is regained. Compared to EEPROM's, Ramtron's shadow RAM architecture can store data without power for 10 years, has the capability of $>10^9$ store/recall cycles, and has a life expectancy of $>11,000$ years at one power loss per hour.

Ramtron's demonstration IC, the FMx 801, is a 256×1 bit non-volatile SRAM. Nonvolatility is accomplished by storing complementary polarization states on pairs of PZT capacitors in each SRAM cell. Those polarization states are retained when power is removed from the device, preserving the information. Information is recovered after power-up by reading those states from the ferroelectric portion of the shadow RAM cell.

A block diagram of the FMx 801 is shown in Fig. 5. The FMx 801 is packaged in a 24 pin DIP. Fourteen of the 24 pins are used to operate the IC as a conventional SRAM. Three of the remaining 10 pins connect to separate ferroelectric devices to distinguish between individual PZT capacitors. The remaining seven pins are used with SRAM pins to achieve nonvolatility by store and recall timing sequences. Two of the seven ferroelectric pins, CRA and CRB, provide power and ground, respectively, to the SRAM cell during the read/write and store operations. The remaining five pins, CTA, CTB, CPA, CPB, and CPRE are control signals that connect or isolate the shadow portion of RAM (ferroelectric portion) to the static RAM cell. The timing parameters and voltage levels of the seven ferroelectric pins are critical for data retention.

For more information on Ramtron's ferroelectric IC's, you can contact them at:
1873 Austin Bluffs Pkwy.
Colorado Springs, CO 80918
Phone: (719) 594-4455

Although FRAM's™ focus on dedicated memory applications, ferroelectric technology can also be applied to logic devices, micro-

EXPERIMENTING WITH FERROELECTRICITY

Ferroelectric technology is not new, but its recent advancements are. Production of the futuristic 74CF374 IC began only last year, and National Semiconductor is wisely taking a cautious approach to marketing these ferroelectric devices. The 74CF374 is now available on a limited basis, and you can become acquainted with this new technology by using the IC in a practical application, such as an event counter.

Presently there is no solid-state equivalent for the venerable solenoid-driven mechanical counter simply because the battery-powered backup circuits needed to keep the semiconductors constantly powered up are too complex and costly in comparison. By using ferroelectrics, however, we can make the solid-state event counter a reality.

The circuit shown in Fig. 6 is a two-digit event counter that totalizes 5-volt input pulses that have a duration of 15 nanoseconds or longer. The two 74LS90 IC's are binary-coded decimal (BCD) decade counters that are the heart of the circuit. Their outputs connect to the inputs of the 74CF374 ferroelectric chip. When pin 11 of the 74CF374 IC goes high, the count from the decade counters is transferred to the IC's output lines, which in turn are decoded by the two 74LS47 IC's for display. The two 74LS00 gates delay the pulse going to the 74CF374's clock pin so that the decade counter outputs have time to stabilize before they are sampled.

The beauty of this circuit is that it doesn't have to be powered up all the time. In fact, when the counter is not in use, you can switch the power off. During the power-off period, the ferroelectric cells inside the 74CF374 remember the number of the last count. When power is restored, the last count will be displayed on the readout just like any mechanical counter. The reset button clears the counter to zero. Although this circuit uses TTL parts, you can use their CMOS equivalents with the 74CF374.

processors, application-specific integrated circuits (ASIC's), and enhancements for linear circuits. Let's look at some other markets in which ferroelectric devices can be used and where they may replace other components.

The future of ferroelectrics

In the short term, ferroelectric devices should find applications in programmable logic IC's, replacing EPROM's, and DIP switches. Mechanical controllers, such as event counters and utility meters, automotive elec-

tronics, robotics, instrumentation, satellites, communication systems, and programmable appliances are other prime sources for ferroelectric foray.

Provided that ferroelectric manufacturing techniques keep pace with burgeoning PC speeds, you'll see more use of ferroelectric memory devices and less use of battery-backed shadow RAM caches. It's even conceivable that all logic IC's may eventually be replaced with ferroelectric counterparts.

Military applications will find ferroelectric devices particularly attractive because of their radiation hardness. In situations where a rad-hardened CMOS memory array would fail, a ferroelectric array could come through unscathed.

Ultimately, ferroelectrics may replace magnetic tapes and drives as the primary source of data storage—something both bubble memory and CD drives have tried but failed to do because of such things as cost and technology limitations.

R-E

Be an FCC LICENSED ELECTRONIC TECHNICIAN!



Earn up to \$30 an hour and more!

Learn at home in spare time. No previous experience needed!

No costly school. No commuting to class. The Original Home-Study course prepares you for the "FCC Commercial Radiotelephone License." This valuable license is your professional "ticket" to thousands of exciting jobs in Communications, Radio-TV, Microwave, Maritime, Radar, Avionics and more...even start your own business! You don't need a college degree to qualify, but you do need an FCC License.

No Need to Quit Your Job or Go To School
This proven course is easy, fast and low cost! **GUARANTEED PASS**—You get your FCC License or money refunded. **Send for FREE facts now. MAIL COUPON TODAY!**

COMMAND PRODUCTIONS
FCC LICENSE TRAINING, Dept. 90
P.O. Box 2824, San Francisco, CA 94126
Please rush FREE details immediately!

NAME _____
ADDRESS _____
CITY _____ STATE _____ ZIP _____

MARCH 1991



SEMICONDUCTOR MEMORIES

An overview of today's revolutionary memory technology—and a peek at tomorrow's.

STEPHEN J. BIGELOW

STORAGE AND RETRIEVAL OF DIGITAL information has sparked an exciting revolution in computers and consumer electronics. You find semiconductor memories in nearly all "intelligent" electronic systems, including car radios, televisions, VCR's, compact-disc players, and computers. Without the on-going advances in memory technology, the high-tech revolution would rapidly grind to a halt.

In this article, we will examine several important concepts behind semiconductor memory devices, including basic technologies, memory organization and configuration, design considerations, and applications.

Memory types

Semiconductor memory devices can be classified in one of two ways: permanent or temporary. Although basic operating principles of both are similar, each plays a different role, and each has unique advantages and disadvantages. We will discuss both types in detail.

As the name suggests, information in *permanent memory* is retained at all times, even after removal of system power. Permanent memory is also called *non-volatile* and *read-only* memory. Permanent memory is most often used to store fixed program in-

structions or numerical constants that do not change during the life of a product. For example, personal computers use permanent memory to hold the basic input/output system (BIOS) that initializes the computer and provides it with a core of low-level functions. There are four basic types of permanent memory: ROM, PROM, EPROM, and EEPROM. Let's discuss each type.

ROM

The read only memory (ROM) is the oldest and most straightforward type of permanent semiconductor memory. The information that's programmed into a ROM is specified by the buyer, but the ROM itself must be built by the manufacturer.

A ROM is relatively inflexible—after it's been programmed, it can never be altered. If the information in a ROM must change, a whole new device must be manufactured and substituted for the old ROM, and that is an expensive, time-consuming process. Hence the ROM is economically feasible only when used in great volumes for thoroughly debugged applications.

One advantage of the ROM is its ruggedness. Since the program is an actual physical part of the device itself, it can withstand

relatively large amounts of electrical and physical abuse, yet still maintain its contents. The automobile industry uses ROM's extensively in on-board computers.

PROM

The programmable read only memory (PROM) offers a tremendous advantage over the ROM in that it can be programmed by the end user, who is then less dependent on manufacturers' lead times. A PROM can be "burned," or programmed, only once because it cannot be erased.

The term *burn* comes from the method used to program a PROM. A factory-fresh PROM consists of a matrix of fusible links. An intact link produces a binary 0 at the selected location; a burned (open-circuit) link produces a binary 1, as shown in Fig. 1. (We'll discuss how to get at a particular location in a PROM later in this article.)

To burn a PROM, a special piece of equipment called a PROM burner generates high-energy pulses which destroy the desired links to match the contents of a user data file.

PROM's are slightly more expensive than ROM's on a per-unit basis, but their flexibility often justifies higher cost. Many PROM's are available through retail electronics outlets.

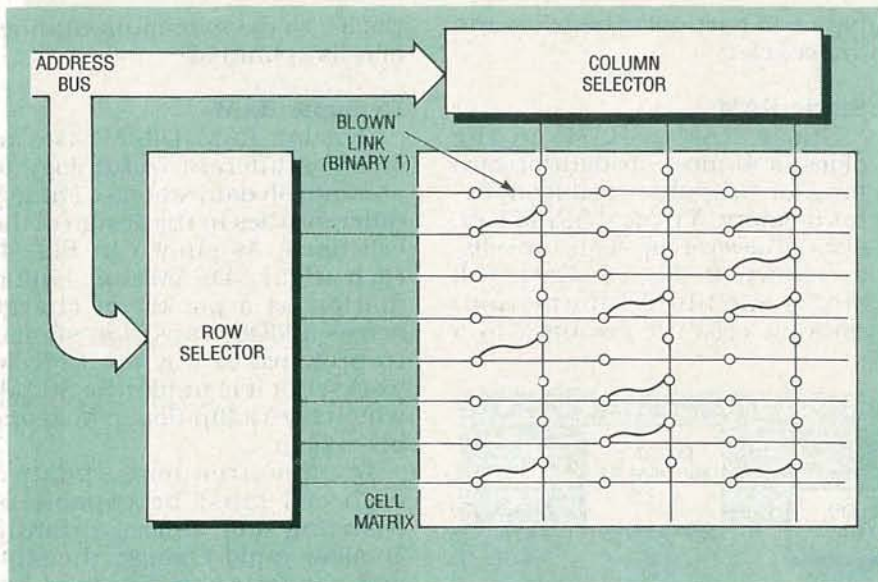

FIG. 1—A PROM BEFORE PROGRAMMING consists of a matrix of fused links joining each row-column intersection. Programming blows desired links.

EPROM

The erasable programmable read-only memory (EPROM) overcomes one of the main disadvantages of the PROM: its inability to be reused. After a link has been burned, it can never be restored. By contrast, typical EPROM's can be reliably burned and erased thousands of times.

The PROM is built around traditional bipolar transistor technology, which uses both a great deal of power and occupies a lot of space. The EPROM, on the other hand, uses newer metal-oxide semiconductor (MOS) technology, which requires little current and occupies little space. In an EPROM, information is stored as small packets of charge buried deep within the substrate of the IC, as shown in Fig. 2.

An EPROM is programmed much like a PROM. A special EPROM programmer selects an address in the device, places the desired binary information on the data lines, and then pulses the EPROM's PROGRAM pin. That pulse is what locks the bit pattern into the substrate of the chip.

To erase an EPROM, it's necessary to remove the charges in the IC's substrate. That's accomplished by exposing the circuit (the die itself) to short-wavelength ultraviolet (UV) light for a prescribed period of time. The excitation created by the UV light allows stored charge to dissipate, so the IC gradually returns to its

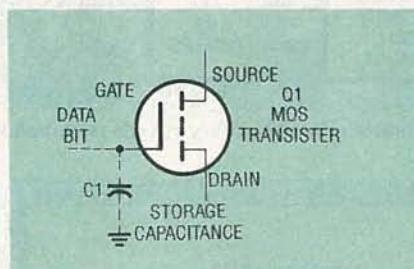

FIG. 2—IN AN EPROM, CAPACITANCE across the gate-drain junction of a MOS transistor provides storage.

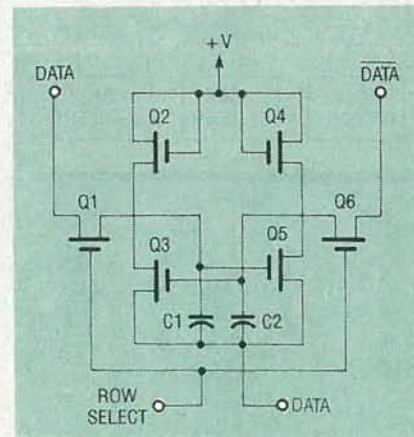

FIG. 3—A FLIP-FLOP is the basic unit of storage in static RAM devices.

pre-programmed state. The UV light is introduced into the EPROM through a transparent quartz window in the top of the IC package.

Use caution when working with EPROM's. Even though it takes about 20 minutes of exposure to a concentrated UV light source to erase an EPROM, some common sources of light, such as

sunlight, fluorescent light and "black-light", may contain enough UV to trigger random charge dissipation and introduce errors in the device. So be sure to cover the quartz window with a piece of opaque material.

EPROM's cost more than PROM's, but cost-per-bit is actually lower because MOS technology allows the designer to squeeze several times more information in the same amount of space. One disadvantage of the EPROM is that it must be physically removed from the system to be erased and re-programmed.

EEPROM's

The electrically erasable programmable read only memory (EEPROM) is similar to the EPROM, but overcomes its main disadvantage: the inability to program it in-circuit. That feature offers exciting possibilities in applications where software must adapt to changes in the operating environment.

The EEPROM is no panacea, however. It's slower than other types of memory, and it requires a relatively long time to update the altered data. As a result, EEPROM's are best suited for holding information that changes infrequently. Information that changes often is best left to the work of temporary memory, the other broad class of semiconductor memory.

Temporary memory

Information held in a temporary semiconductor memory device can be altered and updated frequently, but will be maintained only as long as power is supplied to the device. If power fails, memory contents will be lost. That type of memory is usually referred to as *volatile* memory. It is also known as random access memory (RAM). The name refers to the fact that any location may be accessed as quickly as any other. By contrast, in a sequential device like a tape drive, access speed depends on the location of the desired information. However, random locations in ROM's, PROM's, EPROM's, and EEPROM's can be accessed with equal speed. Nonetheless, when people speak of RAM, they almost invariably are referring to temporary memory.

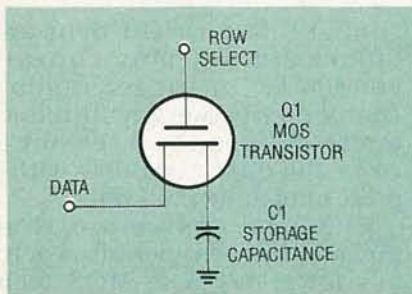

FIG. 4—CAPACITANCE is the basic unit of storage in the DRAM.

type has particular benefits and drawbacks.

Static RAM

Static RAM (SRAM) is the oldest and most straightforward form of temporary semiconductor memory. A typical SRAM consists of several flip-flops, or cells, as shown in Fig. 3. Each cell stores one bit of information; multiple cells are arranged in a

the IC, so the maximum number of cells is limited.

Dynamic RAM

Dynamic RAM (DRAM) uses an entirely different technology to accomplish data storage. The key difference lies in the design of the cell itself. As shown in Fig. 4, each cell in a DRAM stores information as a packet of charge across a MOS transistor, similar in principle to way the EPROM works, but it is unlike the SRAM, which uses a flip-flop to hold one bit of data.

To allow frequent updates, each cell must be capable of changing state almost instantly. To allow rapid change, the storage capacitance must be extremely low, so low in fact that it cannot sustain its charge for more than a few milliseconds. Therefore each DRAM location must be *refreshed* about every two milliseconds. If a cell is not refreshed, it will simply lose its data. However, refresh cannot happen by itself; external circuitry is required, as well as additional circuitry within the DRAM itself. Fig. 5 shows a block diagram of the internal structure of a DRAM. The added complexity and cost of refresh circuitry is the main disadvantage of DRAM.

On the other hand, DRAM offers several distinct advantages over SRAM. Storage capacity is much greater. Common DRAM's provide one megabit (2^{20}) of storage, and four-megabit IC's are just over the horizon. In addition, 16-megabit memories are being developed, and 64-megabit DRAM's are on the drawing board.

Power is another consideration. DRAM's require less current to operate; there are far fewer components per cell to dissipate power. The power savings can be substantial in applications that need a great deal of memory. DRAM's also have a standby mode that essentially disables all functions except refresh. In standby mode, a DRAM requires just a few milliwatts of power to maintain its information. In some cases, the low power requirement makes battery backup practical. SRAM's also have a standby mode, but they typically need more than 100 milliwatts of power. Now let's examine some of

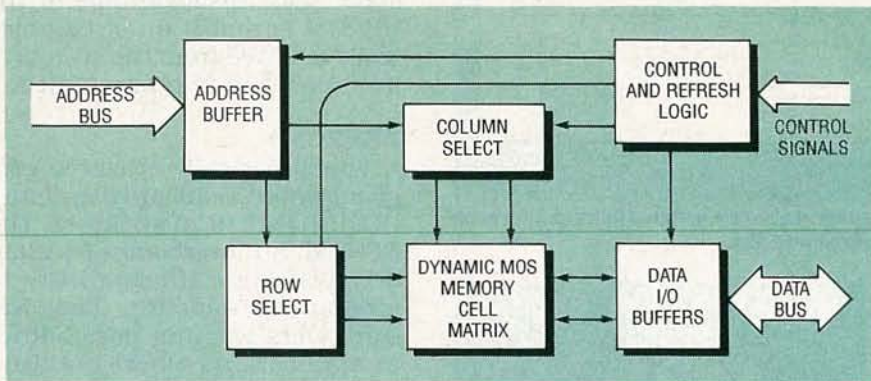

FIG. 5—INTERNAL DRAM STRUCTURE. The control/refresh circuitry increases complexity but drastically increases storage capacity.

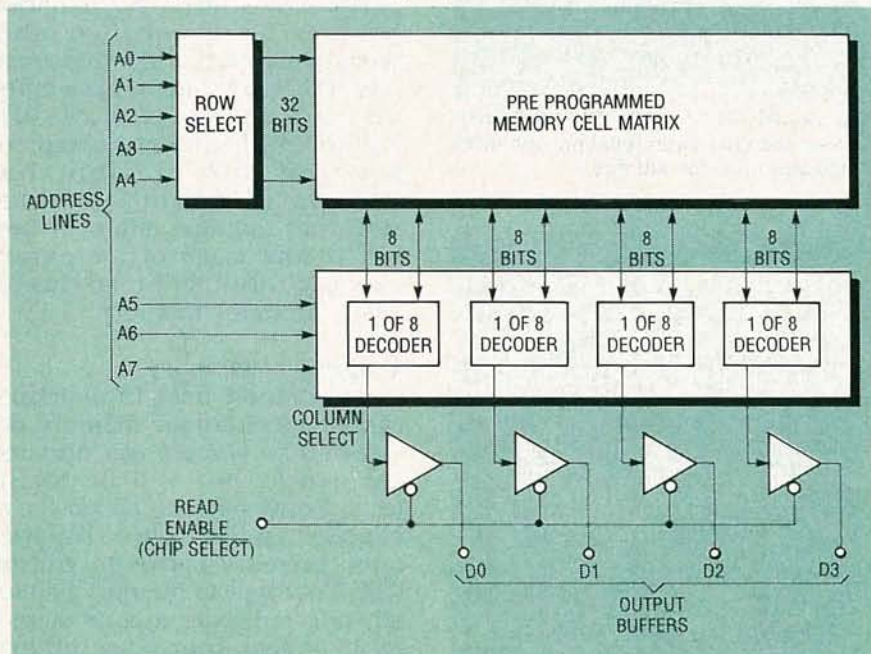

FIG. 6—A BASIC ROM consists of row- and column-select circuitry, the memory array, and three-state output buffers.

Most electronic processing systems require at least some RAM. The amount that's required depends on the application. A simple system, such as a programmable digital thermostat, may require only a few bytes of RAM. But a computer may require millions of bytes of RAM.

There are two basic types of RAM: static and dynamic. Each

two-dimensional array. To access a particular cell, row and column addresses must be set up, and then several control signals must be pulsed.

Since data is always available from the flip-flop matrix, the SRAM tends to be a fast device. Its primary disadvantage is limited capacity. Each flip-flop occupies a relatively large area on

the technologies used to fabricate semiconductor memory devices.

Fabrication technologies

Every semiconductor memory chip houses sophisticated, sensitive microcircuitry. Each minute component must be integrated deep into the substrate of the chip (or die), which itself rests within a hermetically sealed case of plastic or ceramic. The process of *circuit integration* involves a complex combination of optical and chemical processes to form a working IC. Memory devices manufactured today are typically made using either bipolar or MOS fabrication technologies. In addition, a new hybrid of the two technologies, called Bi-MOS, has begun to appear. Although the actual manufacturing processes of these kinds of devices are too involved to cover here, we can review the characteristics and uses of those technologies.

Bipolar technology

The bipolar transistor (with emitter, base, and collector) was the first component successfully integrated into a semiconductor wafer in the form of the TTL IC. Many simple logic functions could thus be synthesized easily and efficiently. The resulting low cost and high availability made TTL a mainstay of digital logic design through the 60's and early 70's. Even to this day, TTL remains a cornerstone of basic logic design. When memories were needed, TTL was the obvious choice.

Although there are several SRAM chips in the TTL family (notably the 74S200 and 74S201), TTL suffers from several major drawbacks that severely restrict the capacity of bipolar SRAM. First, bipolar logic requires a relatively large area on the chip for each logic gate. Many gates are needed to build a SRAM, so space is depleted rapidly. In addition, bipolar logic requires significant operating current per gate. Since current ultimately translates into heat, the number of cells is limited even further. Size and power restraints usually limit the number of bipolar memory cells to fewer than 1000 bits.

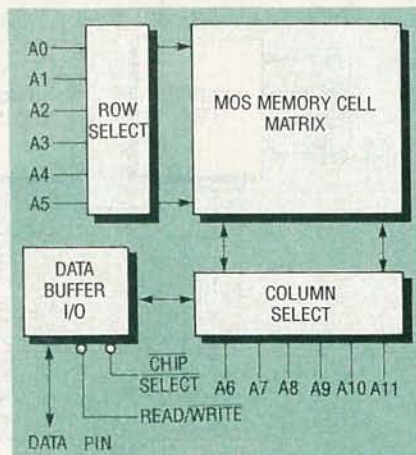

FIG. 7—THE BASIC SRAM is more complicated than a ROM because of the addition of a READ/WRITE line.

MOS technology

The development of MOS technology is largely responsible for the incredible advances in high-tech electronics since the late 1970's. The materials and chemicals used in MOS fabrication are different from those used for bipolar fabrication, but the process is fundamentally the same. The most familiar MOS family is complementary MOS (CMOS), but there are many variations, including PMOS, NMOS, VMOS, DMOS, and HMOS.

CMOS, NMOS, and HMOS devices are the most widespread variations of MOS technology in use today. CMOS has been used extensively in memories, and to produce a family of devices that is functionally similar to the TTL family. CMOS dissipates far less power than TTL and can run on a much wider range of supply voltage (3–15 volts DC). N-channel MOS (NMOS) technology is used to produce memories that are fast, dissipate little power, and can fit many components on a chip. Although early devices required several supply voltages, modern NMOS IC's operate from a single 5-volt supply. High-performance MOS (HMOS) is an NMOS variation that's used in modern high-speed low-power microprocessors.

In spite of their obvious advantages, all MOS devices suffer from one key weakness: they're extremely sensitive to static electricity. There are important precautions that should be taken. Be sure to follow manufacturers' guidelines for handling MOS devices.

Memory operations

To the external world, the organization of a semiconductor memory device appears as a sequence of locations. Each location may have 1, 4, 8, or some other number of bits, but regardless of the number of bits per location, each location has a unique address. The number of unique addresses depends on the number of address lines. If there are 8 address lines, then there are 2^8 or 256 addresses. Although externally a semiconductor device appears to have a sequential organization, internally the cells are arranged in a square.

The relationship between the number of physical cells (bits) and the number of logical locations (addresses) depends on the number of bits per address. For example, a memory IC could have 1 megabit of cells arranged as 1×1 megabit, as $4 \times 256K$, or even as $8 \times 128K$. Internal decoding circuitry varies depending on how the organization is to appear externally.

For example, Fig. 6 represents a simple ROM. The format of the ROM is 256 addresses with four bits per address. The memory array is a 32×32 square, giving 256 addresses. And for 256 addresses the chip requires eight address lines ($2^8 = 256$) to identify each location uniquely. The lower five address lines (A0–A4) select one of 32 possible rows ($2^5 = 32$). The upper three (A5–A7) select one of eight columns ($2^3 = 8$). There are four 1-of-8 decoders, so four columns (one from each group of eight) will be active for each selection.

After a valid address is presented to the address lines, the data bits at the intersections of the selected row and columns will be sent through the respective 1-of-8 decoders to several three-state buffers. If the READ ENABLE signal is brought low, the data present at the buffers will be delivered to the ROM's output. But when READ ENABLE is high, the high impedance of the three-state buffer will simply disconnect the ROM's outputs from the circuit.

SRAM's, along with PROM's, EPROM's, and EEPROM's, are more sophisticated. Figure 7 shows a simple SRAM organized

as 4096×1 . Addressing is similar to the ROM in the previous example but, in this case, there are 12 address lines that provide 2^{12} or 4096 (4K) addresses. One bit of data is available at each address location.

A READ/WRITE control signal determines whether data will be read from or written to the IC. If R/W is logic 1, data will be read from the cell. If R/W is logic 0, data will be written to the cell.

To read a bit of data, a valid address must be supplied, R/W must be high, and the $CHIP\ SEL$ input must be low. To write a bit of data, the same conditions apply except that R/W must be low. The timing relationships between the signals at various pins can be critical, depending on the circuit.

Timing considerations

Today's generation of RAM IC's has been designed to operate at high speeds, so timing characteristics for address, data, and control lines are important. There are several important parameters that we will discuss.

Access time specifies how long it takes after addressing a specific location before valid data appears at the IC's output. A slow memory device may have an access time of as much as 450 nanoseconds, while a fast device might access data in as little as 25 nanoseconds. Common memory devices today have access times of about 100–150 ns. As a rule of thumb, the faster a memory device is, the more expensive it will be.

Settle time specifies the amount of time that must pass after setting up the address, data, and $CHIP\ SELECT$ signals, before the R/W may be pulsed low to write data into the IC.

In addition, the *WRITE* pulse must be held low for a minimum amount of time to ensure that the data is accepted into memory. That is the duration of the *write pulse*. The address, data, and enable signals must be held steady for a minimum time after the write pulse; that period is called the *hold time*.

Those timing parameters apply to SRAM's; DRAM's have even more intricate timing requirements. Although the basic principles of reading and writing are

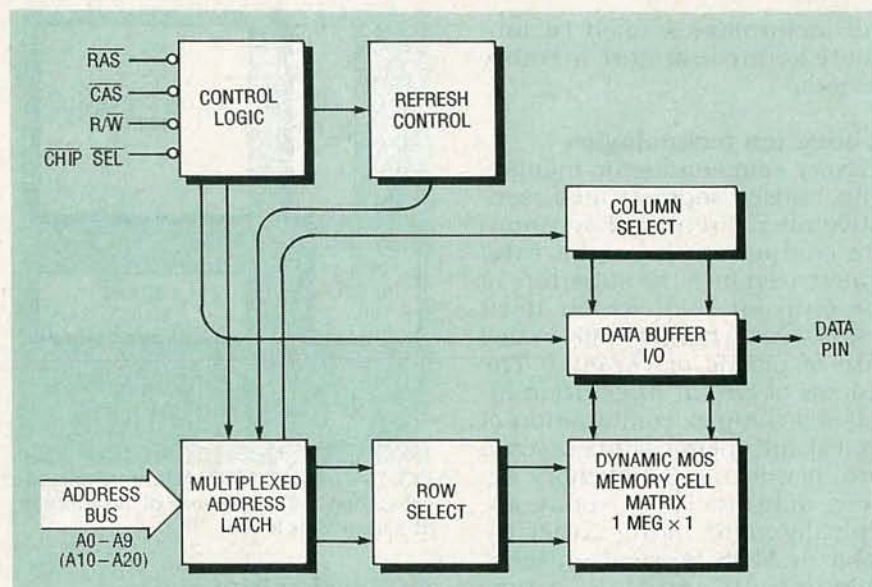

FIG. 8—DRAM KEEPS PIN COUNT LOW by multiplexing address lines on half the expected number of pins. CAS and RAS signals strobe low- and high-order address lines into the IC as necessary.

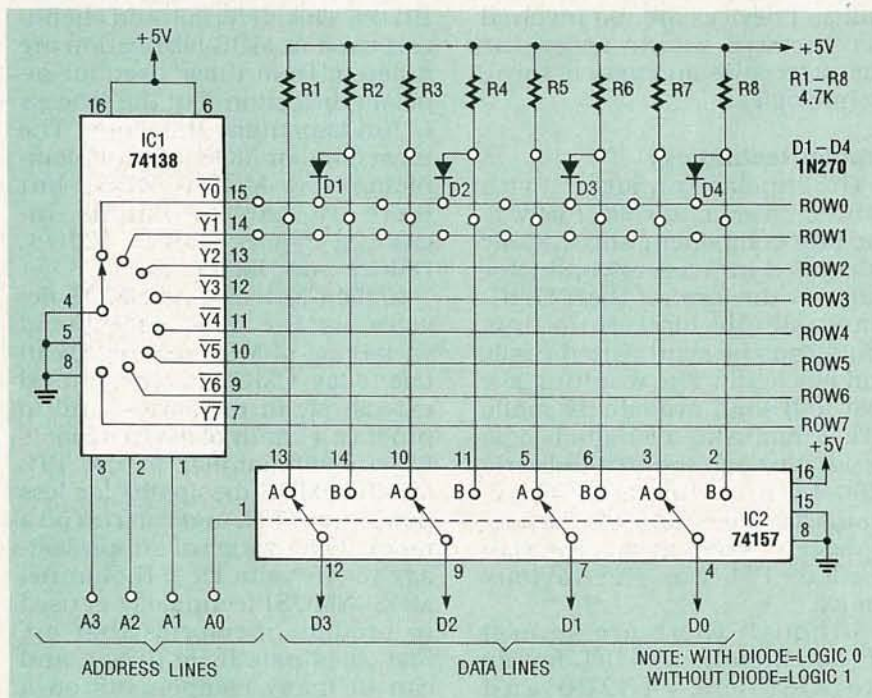

FIG. 9—BUILD AN EPROM EMULATOR from two TTL IC's, eight resistors, and a number of germanium diodes. Place a diode across each row-column intersection that is to be a logical 0.

similar to those for the SRAM, there are some extra features and parameters that must also be considered.

The first involves memory addressing. As discussed earlier, DRAM's can provide millions of bits on one device. For example, addressing 1 megabit (2^{20}) would require 20 address lines. It's possible to build an IC with 20 or more pins, but to save space and reduce pin count, several address

lines are *multiplexed* on a single pin.

Figure 8 shows the block diagram of a 1-megabit \times 1-bit DRAM. Note that only ten address lines enter the IC, so you might think that you could access only 2^{10} (1024) locations. In fact the 20-bit address is broken up into two parts, each of which is supplied separately. The lower ten bits select the desired row in the memory array, and the upper ten

bits select the desired column. The row-address lines are strobed into the IC by pulsing the row address strobe (RAS) input, and the column-address lines by pulsing the column address strobe (CAS) input. External circuitry must ensure that the proper set of address lines is applied to the IC before pulsing a strobe input.

After the IC receives the full address, CHIP SELECT and R/W may be set up, as with an SRAM, to read or write data. The access, setup, and hold times apply to DRAM's as well.

Refresh

As mentioned earlier, DRAM's require periodic refreshing, otherwise their stored charge will dissipate. There are several ways of refreshing a DRAM system, all of which use the RAS and CAS inputs. The simplest method is called *RAS-only refresh*. It involves holding CAS high, which in turn holds the output in a high-impedance, or disconnected, state. The refresh circuitry then selects each row in turn, pulsing RAS low for each row as it is addressed. It does not matter whether all rows are refreshed in one sustained burst, or one row between, for example, read or write operations. As long as a cell is refreshed in time, its data will remain intact.

Hidden refresh is a variation on RAS-only refresh in which CAS is held at logic 0 (for example, valid data is maintained on the output) while rows are selected and refreshed. Depending on system timing, CAS may be held low for several microseconds, during which several rows may be refreshed.

There are other variations, but all refresh circuits add a fair amount of complexity to a circuit. Fortunately, however, there are refresh-controller IC's for many different DRAM sizes and configurations. Those IC's reduce cost, increase reliability, and decrease required PC board space.

EPROM emulator

You can easily assemble your own hand-made "EPROM" using two common TTL IC's and several Germanium diodes. Figure 9 shows the schematic for a 16×4 memory circuit. It's loosely called

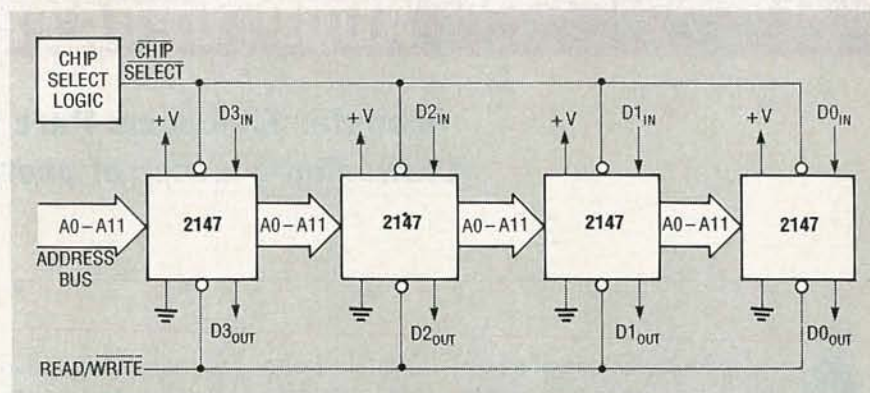

FIG. 10—BLOCK DIAGRAM OF A $4K \times 4$ static RAM array—parallel memory IC's increase bus capacity.

an EPROM because it can be re-programmed at any time by rearranging the diodes in the matrix. Although the circuit is unsuitable for high-performance or microprocessor-based applications, it can be used to supply pre-programmed bit patterns to discrete logic circuits. It also provides an excellent demonstration of basic memory operation.

There are eight rows and eight columns, yielding 64 bits of memory. Two demultiplexers allow access to a particular memory cell. One demultiplexer decodes the row and one decodes the columns. A 74138 1-of-8 decoder selects the row, and a 74157 quad two-input multiplexer selects the columns. Address lines A1-A3 drive the 74138 to select which one of eight rows will be pulled to ground. The columns are arranged in pairs; address line A0 determines which member of a pair is connected to the output.

The 1N270 diodes determine the bit pattern in the circuit. Germanium diodes are used because of their low forward voltage drop (0.3 volts); silicon diodes have a higher voltage drop and will not work with TTL IC's.

Every column is pulled high via a pull-up resistor. If a diode is absent when a particular row is selected, the column will provide a 5-volt output. However, if a diode is in place, it will be forward biased via the pull-up resistor, through the 74138, and then to ground. The corresponding output thus becomes a logical 0.

For example, if address 0000 is selected, 74138 output y_0 (row 0) is connected to ground, and all 74157 inputs are connected to the B position. Because there are

diodes connected to each the B inputs in row 0, the output would be 0000. If the address was 0001, row 0 remains selected, but the 74157 inputs are switched to the A position. The A cells have no diodes, so all outputs would be high (1111).

Parallel memory

Semiconductor memories (both temporary and permanent) can be placed in parallel to increase the number of data bits available per address, as shown in Fig. 10. The circuit is built from several 2147 SRAM's (4096×1). By connecting the address and control lines in parallel, the same address in all IC's will be selected simultaneously. The data bits, of course, are kept separate. You could just as easily place 8, 16, or 32 IC's in parallel to create $4K \times 8$, $4K \times 16$, or $4K \times 32$ memory blocks.

Conclusion

Memory is an integral part of the high-tech revolution. Even the most basic processing circuit would be useless without some sort of memory to store variable data.

As you can see from our comparison of the many different permanent memory devices, there are distinct advantages and limitations to each type. What you choose depends on your individual needs—the ROM is inflexible but rugged, while the PROM can be programmed by the user, but only once because it can't be erased. The EPROM can be programmed and erased over and over again but uses a lot of power and space, while the EEPROM can be programmed while in circuit, but is slow.

R-E

Transfer Functions Part II: Answering a letter of protest

LARRY KLEIN

As someone who doesn't even like to fish, I seem to spend an awful lot of time opening cans of worms. My most recent foray into decanting annelids was my discussion of transfer-functions and Bob Carver's misadventures with *Stereophile* magazine. In a letter to this magazine, *Stereophile* editor John Atkinson took exception to several of my remarks. (See this month's *Letters* column.)

I questioned Bob Carver on some of the disputed facts of the case. It is a "case" because *Stereophile* originally sued Carver for unauthorized reprinting of a *negative* review of one of his amplifiers—along with several laudatory reviews of the same amplifier. Carver's idea was to invalidate *Stereophile's* negative evaluation by contrasting it with several other very positive reviews from other publications. When *Stereophile* sued Carver, he countersued, claiming, in effect, that for several years *Stereophile* had continuously and unfairly disparaged him and his amplifier products.

Since I had not been involved in the chain of events and my knowledge of what occurred was based on a few conversations with Bob Carver and an incomplete collection of *Stereophile*, Atkinson's letter led me to wonder if I had gone factually astray in some areas. I faxed a copy of Atkinson's letter to Carver asking for his comments. At the major points where Atkinson "corrected" me, Carver commented that Atkinson's versions of the events were "simply not true." Who to believe?

The straight facts

One of the things that I didn't learn in kindergarten is that people—in all honesty—tend to remember and/or interpret events in a way that fits into their preexisting world view. So when I'm forced to choose between alternate views of an event, I tend to sup-

port the one that makes objective sense to me and whose advocate has the same way of looking at the world as I do.

I've known John Atkinson since the days when he worked for the British publication *Hi-Fi News*. I watched the publication under his direction abandon rationality and take its readers on an audio "Magical Mystery Tour," frequently promoting products and technologies that lacked any rational technical basis. An example: *HFN* unashamedly promoted a metal brick "Flux Dumper" that purported to improve the sound of an amplifier when simply placed upon the amplifier's metal cage. For me this casts doubt on their overall good sense and seriousness.

When Atkinson came to

Stereophile, his approach dovetailed neatly with that of its publisher. So although he can talk a good scientific line, his editorial approach and product evaluations at *Stereophile* reflect a basically mystical approach to the world of audio.

I won't say that I haven't had disagreements with Bob Carver. But our arguments have involved his use of technically inappropriate names for his usually innovative circuits, his sensitive ego, and his sometimes self-defeating promotional efforts. Nevertheless, I've always been terribly impressed by Carver's design genius and technical rationality. For those reasons, I tend to accept Carver's point of view rather than Atkinson's in regard to the facts in question. Some of the truth of the

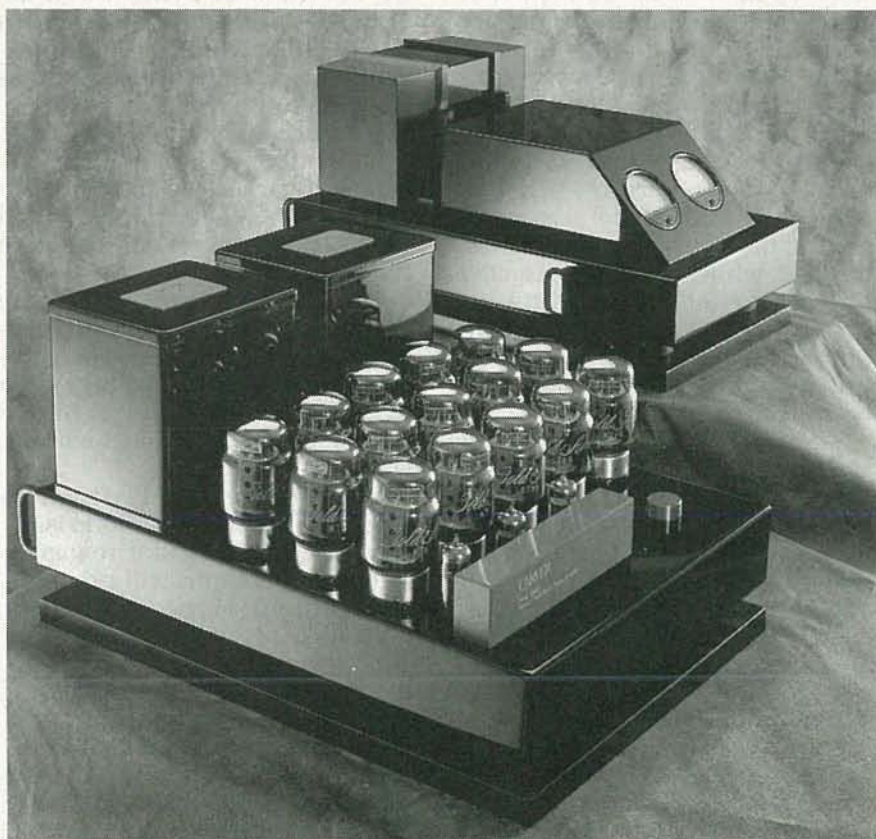

FIG. 1—THE CARVER SILVER SEVEN POWER AMPLIFIER can deliver 375 watts into an 8-ohm speaker load from 20 Hz to 20 kHz with less than 0.5% total harmonic distortion.

matter will undoubtedly be incorporated in the sworn legal depositions given by the two parties involved in the lawsuits.

Flawed evaluations

I may have misrepresented the exact nature of *Stereophile's* reevaluation of the Carver Challenge. Their position seems to be that Carver in 1985 *did* accomplish what he originally claimed he would—make his \$700 M-1.0 solid-state amplifier sound identical to *Stereophile's* \$5,000 Conrad-Johnson mono tube amplifier. However, in 1987 *Stereophile* proved to their own satisfaction that Carver could not duplicate his hand-tweaked prototype in production, despite his ads that claimed he had. They did that by comparing a production-line M-1.0t ("t" for transfer) amplifier with their original tube reference unit.

The flaw in that procedure is obvious to anyone familiar with tube technology. There's a very high probability that in the years between the two comparisons, the parameters of the reference amplifier's output tubes shifted sufficiently to produce an audible difference during critical A-B listening tests.

The correct testing approach would have been to compare Carver's production-line amplifier with his original hand-modified unit. Although *Stereophile* had access to the original unit, they somehow, for some reason, did not get around to making that critical comparison test.

A final word

I stand by my original comments on the cause of the controversy. If by making essentially minor modifications on a \$700 transistor power amplifier Bob Carver can cause it to sound indistinguishable from a \$10,000 (for stereo) audiophile tube amplifier, then the whole rationale for esoteric high-end audio is obviously

Carver has written a 30-page "white paper" explaining his thinking on transfer function-modifications and other technical matters. Priced at \$2.00, it is available postpaid and free of charge to readers of this magazine. Send your name and address to: Carver Corporation, Dept. R-E, P.O. Box 1237, Lynwood, WA 98046-1237.

called into question. And when a magazine's editorial content (and advertising revenues) are based on high-end mystique, there seems to be sufficient reason for them to have second thoughts on the Carver Challenge.

But aside from the motivations of all the parties involved, we still have the problem of how to determine the objective facts of the case. I don't know the answer to that one, except to say that I trust Carver's motivation (and science) over *Stereophile's*.

There's one aspect of the matter that, I must say, leaves me flabbergasted. I won't directly quote *Stereophile's* publisher (for fear that he'll sue for copyright infringement) but his final editorial words on the controversy bemoan the fact that Carver's best design effort was nothing more than a sonic copy of some other manufacturer's amplifier. And in the *Letters* column, some of the magazine's readers were outraged that Carver could mimic the sound of another designer's amplifier without permission. The implication was that the sound was the result of some engineer's hard work and careful listening, and Carver was stealing

LEARN VCR

CLEANING/MAINTENANCE/REPAIR

EARN UP TO \$1000 A WEEK, WORKING PART TIME FROM YOUR OWN HOME!



Secrets Revealed!

NO Special Tools or Equipment Needed.

EARN UP TO \$60 AN HOUR AND MORE!

THE MONEY MAKING OPPORTUNITY OF THE 1990'S

IF you are able to work with common small hand tools, and are familiar with basic electronics (i.e. able to use voltmeter, understand DC electronics). . . .

IF you possess average mechanical ability, and have a VCR on which to practice and learn. . . . then we can teach **YOU** VCR maintenance and repair!

FACT: up to 90% of ALL VCR malfunctions are due to simple MECHANICAL or ELECTRO-MECHANICAL breakdowns!

FACT: over 77 million VCRs in use today nationwide! Average VCR needs service or repair every 12 to 18 months!

Viejo's **400 PAGE TRAINING MANUAL** (over 500 photos and illustrations) and **AWARD-WINNING VIDEO TRAINING TAPE** reveals the **SECRETS** of VCR maintenance and repair—"real world" information that is **NOT** available elsewhere!

Also includes all the info you'll need regarding the **BUSINESS-SIDE** of running a successful service operation!

FREE INFORMATION
CALL TOLL-FREE 1-800-537-0589
 Or write to: Viejo Publications Inc.
 5329 Fountain Ave.
 Los Angeles, CA 90029 Dept. RE

CIRCLE 186 ON FREE INFORMATION CARD

It's no fluke.



Made in the U.S.A.

Building the best DMM for the money is no accident. The new RMS225 was carefully designed to give you what you wanted at a price you could afford. Visit your local distributor today and you'll agree the choice is obvious.

Fluke Model 77	Beckman Industrial RMS225
3-1/2 Digits	4 Digits
3,200 Counts	10,000 Counts
0.3% Accuracy	0.25% Accuracy
Touch Hold®	Probe Hold™
31 Segment Analog Bar Graph	41 Segment Analog Bar Graph
2,000 Hour Battery Life	1,000 Hour Battery Life
10A Range (Fused)	10A Range (Fused)
Protective Holster	Protective Holster
3 Yr. Warranty	3 Yr. Warranty
—	True RMS
—	Auto Min Max™
—	Relative Mode
\$159*	\$149

® Touch Hold is a registered trademark of the John Fluke Mfg. Co., Inc. *1990 Fluke and Philips Catalog

Beckman Industrial™
 An Affiliate of Emerson Electric Co.

Instrumentation Products Division
 3883 Ruffin Road, San Diego, CA 92123-1898
 (619) 495-3200 • FAX (619) 268-0172 • TLX 249031
 Outside California 1-800-854-2708 Within California 1-800-227-9781
 © 1990 Beckman Industrial Corporation. Specifications subject to change without notice. Fluke is a registered trademark of John Fluke Mfg. Co., Inc.
 JN190-01-0391

CIRCLE 98 ON FREE INFORMATION CARD

a valuable property.

I look at the matter somewhat differently. Carver's original design before modification was essentially distortion-free and linear. And its frequency response remained flat with virtually any speaker load it was likely to be connected to. The tube amplifier that *Stereophile* supplied had input and output impedances that varied with frequency, which resulted in small (± 1 dB) frequency-response variations. The specific locations of those variations were somewhat determined by the impedance characteristics of the particular speakers it was connected to.

In my view, the reference amplifier's performance was mildly flawed—but in a way that appealed to *Stereophile*'s critical listeners. Carver's modification of his amplifier consisted of accurately duplicating those existing flaws!

When I originally questioned Carver on this, he said somewhat ruefully that the sonic differences were essentially trivial, and implied that this was his chance to gain credibility with the high-end crowd. I predicted that it wouldn't work because his amplifier

wasn't expensive enough to appeal to devout audiophiles. When this turned out to be true, Carver designed his own amplifier reference standard—the super-audiophile Silver Seven, shown in Fig. 1.

A no-hold-barred, cost-no-object exercise, the \$8,750 two-chassis (but single channel), 350-watt tube amplifier is replete with a plethora of audiophile excesses such as the use of 14 output tubes, audiophile-approved capacitors and resistors, granite-base shock mounting, solid silver internal wiring, oxygen-free wire in the power transformer primary, silver in the secondary, and so forth. A Silver Seven stereo setup will cost you \$17,500. Needless to say, the Silver Seven garnered rave reviews.

Carver duplicated the Silver Seven's transfer function in a 550-watt solid-state mono amp available for a mere \$1,000 and, subsequently, in a series of lower-priced stereo units. I'm sure that the \$17,500 "Silver" amplifier (and its lower priced brethren) sound great, but I wonder if they sound any better than Carver's original *unmodified* M-1.0? **R-E**

Wireless Video Sender 2 (VS2): How You Can Multiply Cable and VCR and Save Money!



VS2 is a wireless home broadcasting system that has just made legal in all 50 states by FCC in 1990. You can save a lot of money with the VS2. There is no need to buy a second VCR or cable box. VS2 multiplies them. VS2 lets you transmit video/audio signal from cable or VCR to any room in your house. Imaging the fun and the many applications you can have with the VS2. You can send your favorite Cable programs or Video from the family room to the TV in your upstairs bedroom, downstairs in the basement, or to the workshop, hobby room, backyard, etc. With a camcorder, you can broadcast a "live" show to your family room, living room, or anywhere in the house that has a TV. Great fun for parties! Turn your camcorder or a security camera and VS2 into a surveillance system. You can watch who is coming to the front door, how baby is doing in the upstairs bedroom, while you work in the kitchen.

If you have two VCRs, you'll find how easy it is to transmit signal from one VCR to another. Now making copies of home videos and other tapes is a snap.

Features:

- VS2 comes with a wireless transmitter and a receiver
- Transmits signals from VCR, cable, satellite receiver, video disc player, camcorder, security camera and more
- 120 ft radius range
- Easy to use and a snap to install
- The best and most exciting wireless video sender
- A/C powered
- Similar units sold elsewhere for \$99 or more
- FCC approved and UL listed—100% Legal!
- 1 year warranty
- Unconditional 30 days Money back guarantee

\$79.95
(\$6 P&H)

To Order: **1-800-445-9285** or **516-568-9850**
Visa/MC, COD, Money Order M-F: 9-6
Zentek Corp. Dept. SRE 3
 581 W. Merrick Rd. Valley Stream, NY 11580

CIRCLE 192 ON FREE INFORMATION CARD

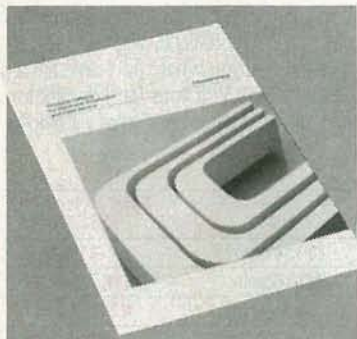

CHEMICAL SOLUTIONS

FREE CHEMTRONICS CATALOG! Comprehensive new source for over 200 products used in electronic manufacturing and field service. E-Series products are CO₂ propelled for ozone safety. Precision cleaning agents, flux removers, bulk solvents, circuit refrigerants, precision dusters, non-residual wipers, premoistened pads/swabs, antistatic compounds, conformal coatings, lubricants, adhesives, desoldering braids and soldering products. Complete with technical specifications and application guide.

Chemtronics Inc.
 8125 Cobb Centre Drive
 Kennesaw, GA 30144
 1-800-645-5244
 in GA 404-424-4888

CIRCLE 54 ON FREE INFORMATION CARD

ATTENTION! ELECTRONICS TECHNICIANS

EARN YOUR
**B.S.E.E.
DEGREE**



THROUGH HOME STUDY

Our New and Highly Effective Advanced-Placement Program for experienced Electronic Technicians grants credit for previous Schooling and Professional Experience, and can greatly reduce the time required to complete Program and reach graduation. No residence schooling required for qualified Electronic Technicians. Through this Special Program you can pull all of the loose ends of your electronics background together and earn your B.S.E.E. Degree. Upgrade your status and pay to the Engineering Level. Advance Rapidly! Many finish in 12 months or less. Students and graduates in all 50 States and throughout the World. Established Over 40 Years! Write for free Descriptive Literature.

**COOK'S INSTITUTE
OF ELECTRONICS ENGINEERING**

CI 4251 CYPRESS DRIVE
 JACKSON, MISSISSIPPI 39212

CIRCLE 58 ON FREE INFORMATION CARD

SUPER LONG PLAY TAPE RECORDERS

12 Hour Model —
USES 120 TAPE
\$119.00*

Modified Panasonic Slimline, high quality AC-DC provide 6 continuous hours of quality recording & playback on each side of cassette for 12 hours total. Includes • Voice level control • Digital counter, etc. TDK — 120 Cassette Furnished.



PHONE RECORDING ADAPTER

Records calls automatically. All Solid state connects to your telephone jack and tape recorder. Starts recording when phone is lifted. Stops when you hang up.

\$28.50*
 FCC APPROVED

VOX VOICE ACTIVATED CONTROL SWITCH
 Solid state. Self contained. Adjustable sensitivity. Voices or other sounds automatically activate and control recorder. Uses either recorder or remote mike. **\$28.50***

*Add for ship & hdg. Phone Adapter & Vox \$1.50 ea. Records \$4.00 ea. Cal. Res. add tax. Mail order. VISA, M/C, COD's OK. Money Back Guarantee. Qty. disc. avail. Dealer Inquiries invited, Free data. ©
AMC SALES INC. Dept. A 9335 Lubec St.
 Box 928. Downey, CA. 90241.
 Phone (213) 869-8519
 FAX (213) 923-1478

CIRCLE 108 ON FREE INFORMATION CARD

DRAWING BOARD

Every test bench needs a good power-supply—here's a rugged 5-volt, 5-amp one you can build yourself.

ROBERT GROSSBLATT

Over the years, I've made a lot of noise about what you need to do to work on the bench. Just because I haven't talked about it in a while doesn't mean that my opinion has changed—it's just that other things have come up that are more interesting. I don't like writing the same thing over and over any more than you like reading the same thing over and over.

I spent a lot of time last month talking about how you have to be systematic when you're working on a design if you want to be able to produce something that works. Not everybody with an understanding of scientific facts has an understanding of scientific method, and all the understanding in the world isn't going to be much good if you don't work in a logical manner. But we've already been through that together.

Now we all know that working your way through an original circuit design is a complex business. Even at the best of times, the hassles that pop up can be unexpected, mysterious, and apparently unrelated to the job at hand. While a healthy dose of scientific method can direct you to the source of the problem, even someone who's logical to the point of being obsessive needs a certain amount of hardware to work things out.

As you probably realized, I'm talking about test equipment. If you've got a bank book to finance your work bench, you probably already have a good supply of test equipment. However, if you're like most of the people I know, the shelf above your bench, while not absolutely bare, is missing some useful stuff.

Test equipment can be divided into two groups—things that should be purchased and things that you can make. Deciding which items to put in which category depends on the kind of work you're doing, the size of your bank account, and your frame of mind. If you like to experiment with multi-zero frequencies or voltages,

both safety and sanity should point you toward store-bought equipment. For most of us, however, home-made test equipment can be a reasonable alternative.

Over the next several months, we're going to go through the design of some basic equipment for your bench. It won't be the world's most sophisticated stuff but, then again, you're not always designing the world's most sophisticated circuitry.

Before we get into designing some hardware, let's spend a minute or so on practicalities. The most common piece of test equipment has got to be a multimeter. There's no reason why you can't build one of your own, but this is a good example of a waste of time, since a good meter can be bought quite inexpensively. If you're willing to look at used equipment, the same amount of money will undoubtedly get you a meter that, a few years before, was the best one you could buy.

Just as some stuff is so cheap that it pays to buy, some test equipment is so complex it pays to buy as well. I'm talking primarily about an oscilloscope. There are ways to convert TV's and monitors to work as oscilloscopes but every one I've seen is more than a one evening's project and

the result is, quite frankly, not worth the time spent on the conversion. If you're interested in building something like that, some companies have kits for scopes that end up being good pieces of test equipment.

Before you go out and spend money, however, be aware that all those kits are complex, costly, and if you screw up it takes a lot of time to get them working properly. When we get further into this, we'll take a look at alternatives to commercial oscilloscopes but there's no way the stuff we'll design will be the functional equivalent of a commercial scope in either bandwidth or features. But you'll see what I mean when we get there.

One of the most basic things to have on your test bench is a good power-supply and that's one of the things you can easily make on your own in just one evening. Since the job of a power-supply is to provide clean power, many good designs can be built around easily available parts. A few years ago, I went through the design of a variable 5-amp power-supply based on the standard 78-series of voltage regulators. If you're interested in all the details, you'll find them in the May to August, 1983 issues of **Radio Electronics**.

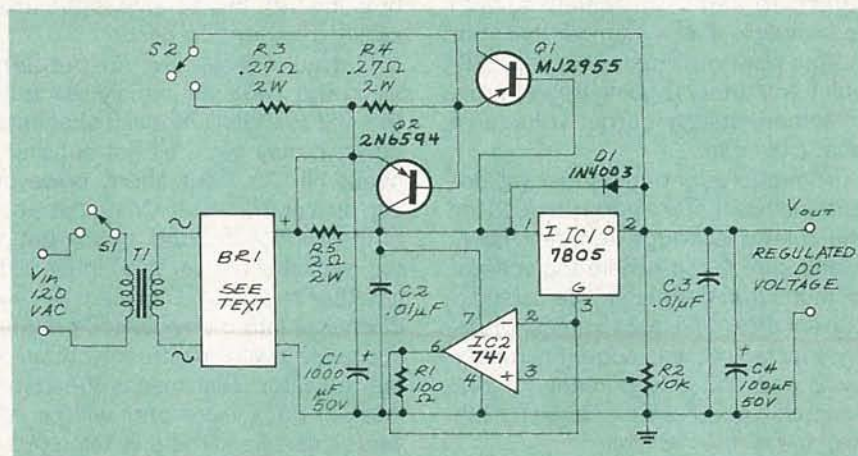

FIG. 1—IN THIS 5-VOLT, 5-AMP POWER-SUPPLY, IC1 is a 7805 voltage regulator; C1, C3 and C4 filter voltage spikes; D1 is a "swamp diode;" Q1 is a pass transistor; and Q2 is a limit transistor.

R-E Engineering Admart

Rates: Ads are 2 1/4" x 2 7/8". One insertion \$995 each. Six insertions \$950 each. Twelve insertions \$925 each. Closing date same as regular rate card. Send order with remittance to **Engineering Admart**, Radio-Electronics Magazine, 500-B Bi-County Blvd., Farmingdale, NY 11735. Direct telephone inquiries to Arline Fishman, area code-1-516-293-3000. FAX 1-516-293-3115. *Only 100% Engineering ads are accepted for this Admart.*

FCC LICENSE PREPARATION

The FCC has revised and updated the commercial license exam. The **NEW EXAM** covers updated marine and aviation rules and regulations, transistor and digital circuitry. **THE GENERAL RADIOTELEPHONE OPERATOR LICENSE - STUDY GUIDE** contains vital information. **VIDEO SEMINAR KITS ARE NOW AVAILABLE.**

WPT PUBLICATIONS
979 Young Street, Suite E
Woodburn, Oregon 97071
Phone (503) 981-5159 Dept. 50

LINEAR IC EQUIVALENTS & PIN CONNECTIONS

Linear IC
Equivalents
and Pin
Connections

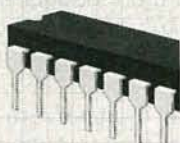

BP141—Shows equivalents & pin connections of a popular user-oriented selection of European, American and Japanese linear IC's. 320 pages, 8 x 10 inches. **\$12.50 Plus \$2.75 shipping.** **ELECTRONIC TECHNOLOGY TODAY INC., PO Box 240, Massapequa Park, New York 11762-0240.**

MIDI PROJECTS



BP182—MIDI interfacing enables any so equipped instruments, regardless of the manufacturer, to be easily connected together and used as a system with easy computer control of these music systems. Combine a computer and some MIDI instruments and you can have what is virtually a programmable orchestra. To get your copy **send \$6.95 plus \$1.25 for shipping** in the U.S. to **Electronic Technology Today Inc., P.O. Box 240, Massapequa Park, NY 11762-0240.**

CIRCLE 190 ON FREE INFORMATION CARD

The final design is shown in Fig. 1. While there's not enough room here to go into a complete analysis of how the circuit was designed, we'll explain how it works. Even though this is a home-built supply, it can supply just as much power as a lot of the commercial ones and should be treated with just as much respect. Five volts may not sound like a lot to you, but at five amps, it can vaporize metal and do all sorts of nasty things.

If you want to get all the power that this supply is designed to deliver, you'll need an input transformer that can put out at least 25 volts and 8 amps. If you can't find one and are forced to settle for something with less muscle, just remember that your output power will be reduced. An 18-volt transformer is going to give you a maximum supply output voltage of about 15 volts.

Your choice of transformer will determine how hefty a part you need for the full-wave bridge rectifier, BR1. Make sure it can handle the voltage from the transformer and can stand a current draw of at least 5 amps. Multiply your voltage and current numbers by 2 and add fifty percent to give yourself a good safety margin for the wattage of the rectifier.

If you've used any of the 78XX regulators before, you'll recognize the basic regulator circuit in the sche-

matic. Capacitors C1, C3, and C4 are used as filters to suppress voltage surges that appear on either the input or output of the supply. Every regulator design has parts to take care of AC ripple and transient voltage spikes.

The shortcoming of the basic regulator design is that whenever you add capacitors to keep the output clean, you're also adding potential problems. One of the most common screwups that has to be handled by a bench power-supply is a short circuit. Since the work area is always littered with clip leads and small pieces of wire (even the ones used on the breadboard), there's always the possibility for shorts to occur.

Output shorts are no problem since the 7805 will rapidly reach its thermal overload point and shut itself down. It may get a bit hot but that's about all. An input short, however, can be a real disaster. When the input of the 7805 is shorted, the output of the regulator will be at a higher voltage than the input. Capacitor C4 will discharge into the regulator's output and current will flow into the output of the regulator. That means the chip's internal pass transistor will be reverse-biased and the only thing you'll be able to do with the 7805 is gold plate it and wear it on your ear.

The problem of an input short is

handled by D1—usually known as the "swamp diode." When everything is working properly, the voltage at the regulator's input will be greater than the voltage at its output and D1 will be reverse biased. If the 7805 input is shorted to ground, however, the output voltage will be higher than the input and D1 will be forward biased. Most of C4's current will be shunted by D1 and passed to ground through the input short, which will save the 7805 and whatever happens to be powered by the supply.

When the regulator's current supply limit is reached (about one amp for a heatsinked 7805), Q1 will work as a pass transistor and take up the extra current demands of the circuit being driven by the supply. Transistor Q1 is set up as a simple switch and is controlled by R5. All the supply current passes through R5 and, as it increases, it will reach a point where the voltage across it is high enough to turn on Q1 and the transistor will start supplying current at the output of the power-supply.

No matter how hefty a transistor you pick for Q1 (the MJ2955 can easily handle 10 amps) the potential is there for the same sort of disaster we saw earlier at the output of the 7805. We can guard against that by putting Q2 in the circuit.

Transistor Q2 is also used as a

switch but its job is to shut everything down if the current draw exceeds a preset limit, hence the name "limit transistor." The turn-on point of Q2 is controlled by R3-R4 in exactly the same way R5 controlled the turn-on point of Q1. When Q2 turns on, however, it will lower the voltage across R5, turn off Q1, and shut down the supply.

The supply's voltage can be varied because of op-amp IC2. The op-amp is set up as a non-inverting buffer to isolate the output stage of the circuit from the regulator's ground leg. When you use R2 to change the voltage at the op-amp's input, you'll also change the voltage at the ground leg of the 7805 and force the supply to vary its output voltage as well.

You won't be able to get 0 volts out of the supply but since there aren't a lot of circuits that run on 0 volts, that shouldn't be much of a drawback. A value of 100 ohms for R1 means you'll have a minimum voltage of about 5.15 volts for the supply.

There's a good deal of math involved in calculating the resistor values so don't stray from them unless you're sure you know what you're doing. The values for R3, R4, and R5 are all linked together so just remember that changing one means changing all of them.

The supply can be built with any technique you want. Just remember to sink the 7805 and all the transistors as well. Put everything in a plastic box and be certain that the whole thing is properly wired together and make sure that all wires are properly covered. If you want to do some experimenting with the current and trip settings, you're going to have to understand the way the values are calculated. It's not difficult since it's really nothing more than an application of Ohm's law.

The value for R5 can be figured out in two ways; the easy way and the hard way. Even though there's a difference in the assumptions made for each method, the practical results are just about the same. If you take a good look at the circuit, you'll see that the emitter-base junction of Q1, along with R3 and R4, should be considered as you calculate R5 since they sit in the circuit with the emitter-collector junction of Q2. That makes things a bit hairy since the impedance of the transistor is going to change with current flow, voltage, and the

other circuit parameters. Speaking practically, however, the effect of Q1's emitter-base junction is minimal compared to the voltage drop across R5 so we can safely do things the easy way and ignore Q1.

With that in mind, we can calculate the value of R5 by a straight application of Ohm's law. The 7805 can easily handle half an amp but let's play it safe and have Q1 turn on when the current flow in the regulator exceeds 250 milliamps. The turn-on voltage for Q1, as it is for any silicon transistor, is 0.65 volts. Since we want it to turn on when the current flow is 250 milliamps, we can get the value for R5 from Ohm's law.

$$\begin{aligned} R5 &= E/I \\ R5 &= 0.65 \text{ V}/0.250 \text{ A} \\ R5 &= 2.6 \text{ ohms} \end{aligned}$$

Since R3 and R4 are in series with R5, the value of 2.6 ohms is therefore the total for all three resistors. In order to find the correct value for R5, we have to work out the value for the parallel combination of R3 and R4.

The problem can be simplified by ignoring the emitter-base junction of Q2. The practical effect is minimal and the value we get without considering it is, as they say, "close enough for government work."

$$\begin{aligned} R3/R4 &= E/I \\ R3/R4 &= 0.65 \text{ V}/5.0 \text{ A} \\ R3/R4 &= 0.13 \text{ ohms} \end{aligned}$$

The final value for R5 is simply

$$\begin{aligned} R5 &= R_{\text{TOTAL}} - (R3/R4) \\ R5 &= 2.6 - 0.13 \\ R5 &= 2.47 \text{ ohms} \end{aligned}$$

Since a 2.47-ohm resistor isn't exactly a common thing, I've used a standard 2-ohm value instead. That changes the circuit trip points a bit but makes building it much easier. You can use several resistors in combination to get 2.47 ohms but it's not really worth the trouble.

When we get together next time, we'll look at some test equipment to build. We'll start out with some standard digital stuff and see where we can go from there. You'll begin to see that, even though some test equipment is too complex to build, there are other items that can be built quite easily. You'll not only save money by building certain items, but you'll also gain a complete understanding of how the device works, and have the fun of building it yourself. R-E

DMM Test Leads That Will Last. At Last.



On the bench or out in the field you're left to your own devices. That's why Pomona has developed 12 different DMM Test Lead Kits. You can reliably attach different probes or clips to the same lead because Pomona's "Pop Jack" coupler holds tight, just like a chinese finger puzzle until you "unlock" it. Silicone insulated wire feels great, won't be burned by the bump of a soldering iron, and stays flexible in cold temperatures.

Choice Quality, Choice Selection.

These, and a host of other features like field repairability, low-cost slide-on tips, extendable and replaceable probe tips, and a rugged pouch or case to fit in pocket or toolbox, make them the best choice. Someone's finally making test leads that will last. See your nearest Authorized Pomona Distributor or contact

POMONA ELECTRONICS
1500 E. Ninth St.,
P.O. Box 2767
Pomona, CA 91769
(714) 623-3463
FAX (714) 629-3317



FREE
1990 CATALOG!
Thousands of test accessories
and solutions in 138 pages.
Call or write for your **FREE**
copy today!

ITT Pomona
AN ITT EMC WORLDWIDE COMPANY
Discover our strengths.

MARCH 1991

SELECT 5 BOOKS for only \$4⁹⁵

(values to \$130.70)
and get a **FREE Gift!**

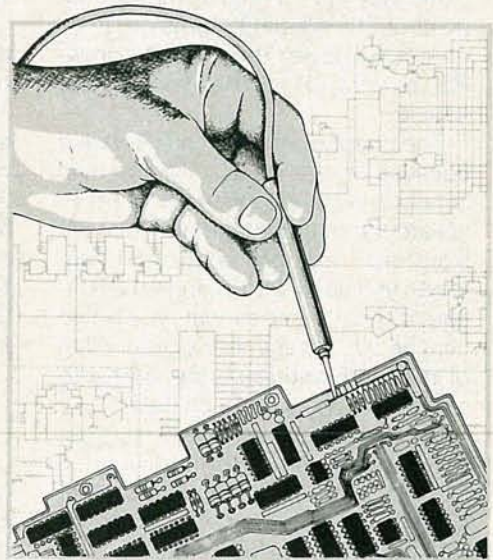

3165 \$17.95



2883P \$17.95



1367P \$24.95



3360 \$29.95
Counts as 2



2613P \$17.95



3307 \$26.95
Counts as 2



2980P \$19.95



2865P \$14.95



3358 \$28.95
Counts as 2

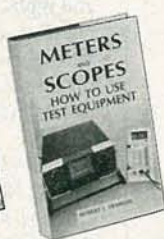

2826P \$16.95



3455 \$25.95
Counts as 2



3321P \$16.95

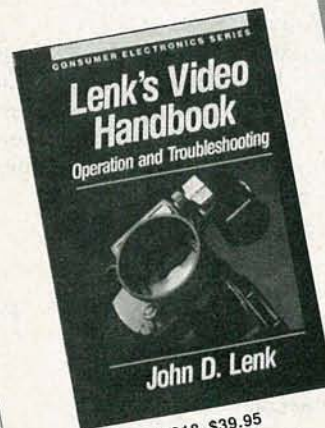

10018 \$39.95
Counts as 2

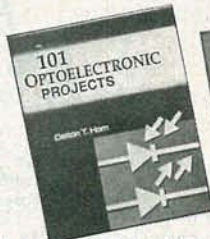

3205 \$24.95



3219 \$27.95
Counts as 2

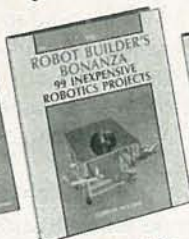

2800P \$16.95



2920 \$29.95
Counts as 2



3312 \$23.95



2941P \$15.95



3285 \$25.95
Counts as 2



3355 \$26.95
Counts as 2

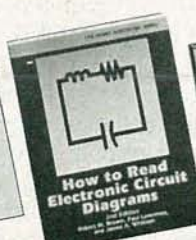

2880P \$14.95



3157P \$16.95



3270 \$32.95
Counts as 2



1897P \$15.95

For over 25 years, your most complete source for electronics books.

An Absolutely No-Risk Guarantee.



3329 \$29.95
Counts as 2



2867P \$18.95

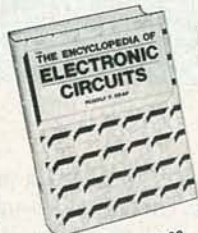

1938 \$60.00
Counts as 3



2925P \$9.95



3034P \$13.95



3138 \$60.00
Counts as 3



3374P \$16.95

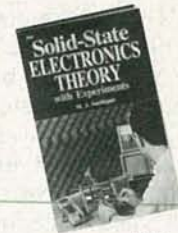

2926 \$25.95



3279 \$36.95
Counts as 2



3031P \$17.95



2996P \$13.95



3260 \$22.95



2898P \$15.95



2897P \$16.95

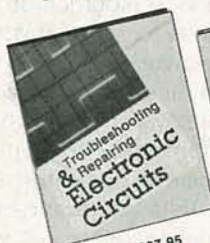

3258 \$27.95
Counts as 2



3145 \$19.95

FREE when you join!

15 Easy Electronic Projects From Delton T. Horn

Projects you can build—some unique, some old favorites—from the author's vast treasury of electronics know-how.

A \$7.95 Value!

Delton T. Horn's All-Time Favorite Electronic Projects



ELECTRONICS BOOK CLUBSM

Blue Ridge Summit, PA 17294-0810

YES! Please accept my membership in the Electronics Book Club and send the 5 volumes listed below, plus my FREE copy of Delton T. Horn's All-Time Favorite Electronic Projects (3105P), billing me \$4.95. If not satisfied, I may return the books within ten days without obligation and have my membership cancelled. I agree to purchase at least 3 books at regular Club prices during the next 12 months and may resign any time thereafter. A shipping/handling charge and sales tax will be added to all orders.

--	--	--	--

Name _____

Address _____

City _____

State _____ Zip _____ Phone _____

Signature _____

Valid for new members only. Foreign applicants will receive special ordering instructions. Canada must remit in U.S. currency. This order subject to acceptance by the Electronics Book Club. RE391

Membership Benefits • Big Savings. In addition to this introductory offer, you keep saving substantially with members' prices of up to 50% off the publishers' prices. • **Bonus Books.** Starting immediately, you will be eligible for our Bonus Book Plan, with savings of up to 80% off publishers' prices. • **Club News Bulletins.** 15 times per year you will receive the Book Club News, describing all the current selections—mains, alternates, extras—plus bonus offers and special sales, with scores of titles to choose from. • **Automatic Order.** If you want the Main Selection, do nothing and it will be sent to you automatically. If you prefer another selection, or no book at all, simply indicate your choice on the reply form provided. You will have at least 10 days to decide. As a member, you agree to purchase at least 3 books within the next 12 months and may resign at any time thereafter. • **Ironclad No-Risk Guarantee.** If not satisfied with your books, return them within 10 days without obligation! • **Exceptional Quality.** All books are quality publishers' editions especially selected by our Editorial Board. (Publishers' Prices Shown)

All books are hardcover unless number is followed by a "P" for paperback. ©1991 ELECTRONICS BOOK CLUB, Blue Ridge Summit, PA 17294-0810

**Or Call Toll-Free
1-800-233-1128 To Join Today!**

MARCH 1991

Making connections.

JEFF HOLTZMAN

Eventually, even small offices like mine have to face up to the fact that a bunch of stand-alone PC's is not as powerful as a bunch of networked PC's. But networks are notorious for being expensive, difficult to administer, and time-consuming. In fact, cost is not a major problem; there are numerous low-cost packages designed for networking a small office. Initial installation of most low-cost packages is fairly simple, but depending on the complexity of your setup, administrative requirements increase rapidly, as does the requisite amount of time.

During the past few years, I've installed and tried to work with several low-cost LAN solutions, including DeskLink, LANLink, PrinterLAN, ReadyNet, and most recently, LANtastic. In each of the first four cases, a brief trial period was enough to convince me that networking would have to wait. LANtastic, however, looks like it's going to stay—at least in my system, that is.

Why bother?

One problem I had to solve was a lack of expansion slots. In my main PC I simply don't have enough interface slots for modem, fax, video, serial/parallel ports, memory, scanner, tape backup, floppy and hard disk drives. Rather than finding a special motherboard with 16 slots, I can use off-the-shelf hardware, simply add another PC to the net, and gain several additional slots. So, in a very real sense, a network becomes a kind of bus extender. And doing it that way makes the overall system more reliable, because if a machine goes down, the system as a whole remains operational. If I stuffed everything in just one PC, and it died, I'd surely be in deep trouble.

Another problem is printer sharing. Laser printers still aren't cheap enough to dedicate one per machine unless, that is, if you have a tremendous bank account. There are inex-

pensive ways to share a printer, but doing it via a network provides a great deal more flexibility, not to mention speed. By letting a PC other than your main one function as a print spooler, printing from your main machine returns you to your task quicker, meanwhile letting the spooler dump your job to the printer as fast as possible.

Another problem concerns system backups. You can carry an external tape drive from machine to machine, backing up each in turn. Or a much easier solution is that you can connect all machines via the network and back each one up from a central location, depending on your network architecture.

The downside to those benefits is the expense of buying, installing, and maintaining a network. Over the long haul, the initial purchase and installation will be a fraction of the overall cost of a network. So one measure of the appeal of a network for a small office is the difficulty of the path from simplicity to sophistication. In other words, can you start out simple and increase sophistication gradually? Of course, there are numerous technical concerns that you must think about before installing a network system: network architecture, speed, compatibility, cabling, and so on.

LANtastic

LANtastic has a great reputation. After playing with it over the past sev-

eral months, it's easy to say that its reputation is well deserved. LANtastic is inexpensive, easy to install, and easy to grow with. It lets you start simple and get as sophisticated as you need. LANtastic is truly frugal in its use of RAM, and its drivers can be loaded in the twilight zone between 640K and 1MB, thereby leaving you with a large chunk of conventional memory. In this day of multi-mega-byte software, it's really amazing what LANtastic can do. Figure 1 shows a photograph of a populated LANtastic board.

If you know anything about networks, you know that there are two basic architectures: server and peer-to-peer. LANtastic provides features of both types of architectures. A LANtastic network consists of at least one server and one workstation. Resources on a server are available to other machines across the network, subject to security constraints; resources on a workstation are available only to that workstation. Some network operating systems require a dedicated server, but under LANtastic, a server can function simultaneously as a workstation. It will run slower than a plain workstation, but by running non-demanding software, you can get away with a non-dedicated server until your business can really justify one. Running a PC as a server requires more memory than a simple workstation.

LANtastic can run on several varieties of hardware, including plain serial ports, proprietary two-megabit/second adapter cards (\$249 each), or standard 10MBPS Ethernet cards (\$349 each). Artisoft sells two-station starter kits for \$199, \$525, and \$725, respectively. The 2MBPS card is interesting because it contains its own on-board CPU and RAM, so conventional memory usage is cut to just a few K. However, for performance reasons, I've been playing with the Ethernet kit. In my case, LANtastic requires about 27K on a



FIG. 1—THE LANtastic networking system offers advantages of both server and peer-to-peer architectures.

R-E Computer Admart

Rates: Ads are 2 1/4" x 2 3/4". One insertion \$995 each. Six insertions \$950 each. Twelve insertions \$925 each. Closing date same as regular rate card. Send order with remittance to Computer Admart, Radio-Electronics Magazine, 500-B Bi-County Blvd., Farmingdale, NY 11735. Direct telephone inquiries to Arline Fishman, area code-1-516-293-3000. FAX 1-516-293-3115. Only 100% Computer ads are accepted for this Admart.

GETTING THE MOST FROM YOUR PRINTER

Getting The Most From Your Printer



BP181—It is probable that 80% of dot-matrix printer users only ever use 20% of the features offered by their printers. This book will help you unlock the special features and capabilities that you probably don't even know exist. To order your copy send **\$6.95 plus \$1.50 for shipping** in the U.S. to **Electronic Technology Today Inc., P.O. Box 240, Massapequa Park, NY 11762-0240.**

SECRETS OF THE COMMODORE 64

Secrets of the COMMODORE 64



BP135—A beginners guide to the Commodore 64 presents masses of useful data and programming tips, as well as describing how to get the best from the powerful sound and graphics facilities. We look at how the memory is organized, random numbers and ways of generating them, graphics-color-and simple animation, and even a chapter on machine code. Get your copy today. Send **\$5.00 plus \$1.25 for shipping** in the U.S. to **Electronic Technology Today Inc., P.O. Box 240, Massapequa Park, NY 11762-0240.**

ICs PROMPT DELIVERY!!!

SAME DAY SHIPPING (USUALLY)
QUANTITY ONE PRICES SHOWN FOR JAN. 6, 1991

Memory For Almost ALL Computers

DYNAMIC RAM		
4M Board for hp LJ's w/2MB		\$160.00
SIMM 2M IBM PS/2 Model 70		145.00
SIMM 4Mx9	80 ns	290.00
SIMM 1Mx9	80 ns	52.00
4Mbit	4Mx1 80 ns	38.00
4Mbit	1Mx4 80 ns	47.00
1Mbit	1Mx1 80 ns	5.60
41256	256Kx1 100 ns	2.40
41256	256Kx1 120 ns	2.20
44256	256Kx4 100 ns	5.25
4464	64Kx4 100 ns	1.95
41264*	64Kx4 100 ns	5.95
EPROM		
27C1000	128Kx8 200 ns	\$14.00
27C512	64Kx8 120 ns	5.25
27256	32Kx8 150 ns	6.75
27128	16Kx8 250 ns	3.65
STATIC RAM		
62256P-10	32Kx8 100 ns	\$6.95
6264P-12	8Kx8 120 ns	4.25

OPEN 6 1/2 DAYS, 7:30 AM-10 PM. SHIP VIA FED-EX ON SAT.

SAT DEL ON FED-EX ORDERS RECEIVED BY: 12:00 PM. MasterCard/VISA or UPS CASH COD. MICROPROCESSORS UNLIMITED, INC. 24,000 S. Peoria Ave., BEGGS, OK 74421 (918) 267-4961. No minimum order. Please note prices subject to change! Shipping, insurance extra, up to \$1 for packing materials.

CIRCLE 61 ON FREE INFORMATION CARD

386 workstation (loading nothing "high"), and about 40K on a 286 server (loading low-level drivers "high").

Installing the AE-2 Ethernet card involves setting a few jumpers to select an IRQ level, an I/O port, cable type, and a few other things. The

AE-2 can run in 8- or 16-bit mode. In my initial installation in an old 16-MHz Dell 386, I had to run in 8-bit mode. However, after upgrading the mother-

ADOBE POSTSCRIPT CARTRIDGE

LaserJets are wonderful. I've had a Series II for about two years, and can't imagine going back to a clanking, clattering dot-matrix printer. However, dealing with soft fonts is, to say the least, a major headache. In addition, some types of software produce much better output on PostScript devices than they do on LaserJets.

Until now, there was no clean way of getting PostScript output on a LaserJet. Yes, there are software emulators, but they're buggy and drain system resources faster than a Teenage Mutant Ninja Turtle can down a slice of pizza. Several companies have released PostScript cartridges for the LaserJet II, but past efforts have been plagued by performance and compatibility problems.

That's all changed with the release of the Adobe PostScript Cartridge (APC). Adobe invented the PostScript language and appears to have mastered LaserJet internals as well. For years, Adobe concentrated exclusively on the Macintosh market, but with the high popularity of Win3, the company has been showing more

and more interest in the PC world. Based on the products I've seen so far, it's too bad Adobe didn't come over to our corner sooner.

Using the APC is admirably simple. Just plug it into the left cartridge slot of your LJII, reconfigure your software, and you've got a low-cost PostScript engine with good performance and built-in LJII compatibility.

You can switch between LJ and PS modes by pressing keys on the front panel or via software. Adobe includes a 10K TSR that switches modes for you automatically. Mode switching is useful because you can't normally dump READ.ME and other text files to a PostScript printer; nor can a PostScript printer print native LaserJet files. You can declare either LJII or PostScript as default; whenever the software detects a stream of printer data in the other mode, it resets the printer and puts it in that mode. The software also provides templates for printing raw text files in small fonts, sideways, two or four sheets to a page.

Mode switching works fairly well, but you must wait for one print job to

finish before sending another job in a different mode. For example, I sent a PostScript job immediately followed by a straight text file. While the last page of the PostScript job was still rolling out of the printer, the printer switched modes, causing the partially ejected paper to stop moving momentarily. After mode switching was complete, the sheet ejected, but it had a big black smudge where it rested against a toner roller.

As long as print jobs are kept separate, the mode-switching software works fine on a LANtastic print server. Any station on the network can arbitrarily print LJII or PS files across the network, and the print server will put the printer in the appropriate mode for that file.

Adobe is quickly becoming one of my favorite companies, because its products allow me to work better. By handling fonts and printer emulations automatically, the software lets you think about the real problem, not the tool being used to solve it. And that's how it should be. P.S. Mail order prices for Adobe products typically range from 40% to 60% list prices.

DIGITAL VIDEO STABILIZER ELIMINATES ALL VIDEO COPY PROTECTIONS



While watching rental movies, you will notice annoying periodic color darkening, color shift, unwanted lines, flashing or jagged edges. This is caused by the copy protection jamming signals embedded in the video tape, such as Macrovision copy protection. Digital Video Stabilizer: RXII completely eliminates all copy protections and jamming signals and brings you crystal clear pictures.

WARNING :
SCO Electronics and RXII dealers do not encourage people to use the Digital Video Stabilizer to duplicate rental movies or copyrighted video tapes. RXII is intended to stabilize and restore crystal clear picture quality for private home use only.

(Dealers Welcome)

FEATURES:

- Easy to use and a snap to install
- State-of-the-art integrated circuit technology
- 100% automatic - no need for any troublesome adjustments
- Compatible to all types of VCRs and TVs
- The best and most exciting Video Stabilizer in the market
- Light weight (8 ounces) and Compact (1x3.5x5")
- Beautiful deluxe gift box
- Uses a standard 9 Volt battery which will last 1-2 years.

To Order: \$49.95 ea + \$4 for FAST UPS SHIPPING
1-800-445-9285 or **516-568-9850**
Visa, M/C, COD M-F: 9-6 (battery not included)
SCO ELECTRONICS INC.
Dept. CRE3 581 W. Merrick Rd. Valley Stream NY 11580
Unconditional 30 days Money Back Guarantee

CIRCLE 181 ON FREE INFORMATION CARD

CABLE TV DESCRAMBLER How You Can Save Money on Cable Rental Fees

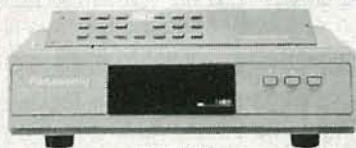

1 Unit 5+	
Jerrold SB w/Tri-Bi.....	\$99.....\$70
SuperTri-Bi (TBM).....	\$109.....\$75
Jerrold 450 combo.....	\$189.....\$139
Scientific Atlanta.....	\$109.....\$75
SA 8536.....	\$250.....\$195
Pioneer.....	\$109.....\$79
Oak KN12 (w/V5).....	\$109.....\$65
Hamlin MLD 1200.....	\$89.....\$59
Tocom.....	\$169.....\$129
Stargate converter.....	\$89.....\$69
Panasonic TZPC145.....	\$99.....\$79

**US Cable will
Beat Anyone's
Price
Advertised in
this Magazine!**

30 Days Money Back Guarantee
Free 16 page Catalog

Visa, M/C, COD or send money order to:
US Cable TV Inc. Dept. KRE 3
4100 N. Powerline Rd., Bldg F-4
Pompano Beach, FL 33073

1-800-445-9285

For Our Record

I, the undersigned, do hereby declare under penalty of perjury that all products purchased, now and in the future, will only be used on Cable TV systems with proper authorization from local officials or cable company officials in accordance with all applicable federal and state laws. FEDERAL AND VARIOUS STATE LAWS PROVIDE FOR SUBSTANTIAL CRIMINAL AND CIVIL PENALTIES FOR UNAUTHORIZED USE.

Date: _____

Signed: _____

No Florida Sales!

board to a modern 25-MHz board made by Hauppauge, I was able to run 16-bit mode without a problem. (Incidentally, my other hardware and software problems, discussed last month, also disappeared after the AE-2 Ethernet card was installed.)

Software installation consists of copying low-level drivers to your hard disk and then running an installation program. If you've got any experience installing PC peripherals, it shouldn't take more than an hour or two to get a two-station system up and running. Fine-tuning resource allocation and security levels will take somewhat longer, depending on your needs.

You use a program called NET to log in and out of the network, map network drives to local drive letters, send and receive mail, manage the print queue, and so on. NET runs in a menu-driven mode; it also runs with command-line parameters, so you can create a batch file to set your system up the way you like it automatically. For example, the following command maps the local LPT1 port to a printer called HPLJII that is located on a server called AST: NET USE LPT1 \\AST\HPLJII. After executing that command, any attempt to print to LPT1 would send all print data across the network to the AST server, which would then dole that data out to the printer. A similar program called NET MGR provides server-management functions, and a program called LAN pop-up (LAN-PUP) is a TSR that provides hot-key access to basic network functions. LANPUP won't pop up directly under Windows, but it will run in a DOS window under Win3.

How does it run?

For basic file and printer sharing, LANtastic works just fine. I've had no trouble operating several servers and workstations, including both 286 and 386 boxes, under both DOS and Windows 3.0.

However, I have had a few problems. Artisoft states that LANtastic is CD-ROM compatible, and although I have heard reports of successful CD-ROM installations, so far I've been unsuccessful. I can map a server-mounted CD-ROM drive to a workstation, but from there I see a nearly-empty root directory and can't get at anything on the drive. At the server, however, the drive works fine.

LANtastic's technical support is

ITEMS DISCUSSED

● LANtastic Two-Station AE-2 Ethernet Starter Kit (\$725), Artisoft, 575 East River Road, Tucson, AZ 85704. (602) 293-6363.

CIRCLE 41 ON FREE INFORMATION CARD

● Adobe PostScript Cartridge (\$495), Adobe Type Manager (\$99), Adobe Plus Pack (\$198), Adobe Systems Incorporated, 1585 Charleston Road, P.O. Box 7900, Mountain View, CA 94039-7900. (800) 83-FONTS.

CIRCLE 42 ON FREE INFORMATION CARD

so-so. Once when I called, I was placed on hold for about 15 minutes. The person who finally answered was fairly knowledgeable, and did help me solve an installation problem. I called another time (the CD-ROM problem) and was bounced around a phone system that eventually allowed me to leave a message, but it warned me that it would take three to five days for a return call. I'm still waiting.

There are also some limitations running under Windows 3.0, although those are limitations of Windows, not LANtastic. The biggest problem is that you can't run a server in enhanced (386) mode. Another problem relates to messaging. For example, you can send a one-line message to another station using the NET program (e.g.: NET SEND DELL386 "This is a message"). When a station running Win3 receives a network message, it just beeps unless you happen to be in a full-screen DOS window, in which case the message appears as normal in its own pop-up window. Also, support for network connections and manipulation of printer queues is weak. I sincerely hope that Artisoft gets together with Microsoft on the next release of Windows to support the functions that the big guys get.

Another complaint is that LANtastic's monitoring functions don't provide real-time updates. For example, if you're viewing the contents of the print queue, and another file comes in (or a file is printed and deleted), the display is not updated. To see the change, you have to go out of and come back in to that screen.

All in all, though, LANtastic is a really well-done product. It's easy to install, provides high functionality with modest system requirements, and runs on a variety of hardware. All PC products should work so well and operate so easily.

MARKET CENTER

FOR SALE

DESCRAMBLERS. All brands. Special: Combo Jerrold 400 and SB3 \$165.00. Complete cable descrambler kit \$39.00. Complete satellite descrambler kit \$45.00. Free catalog. **MJM INDUSTRY**, Box 531, Bronx, NY 10461-0208.

TUBES: "oldest," "latest." Parts, schematics. SASE for lists. **STEINMETZ**, 7519 Maplewood Ave., RE, Hammond, IN 46324.

ENGINEERING software, PC/MSDOS. Hobbyists — students — engineers. Circuit design and drawing, PCB layout, Logic simulation, FFT analysis, Mathematics, Circuit analysis. Call or write for free catalog. 1 (800) 728-3805, **BSOFT SOFTWARE**, 444 Colton Rd., Columbus, OH 43207.

CABLE TV DESCRAMBLERS! BARGAIN HEADQUARTERS!



- JERROLD™ •TOCOM •HAMLIN
- OAK •ZENITH
- SCIENTIFIC ATLANTA

6 month warranty! We ship C.O.D.!
Lowest retail/wholesale prices!

FREE CATALOG:
Global Cable Network
1032 Irving St. Suite 109
S.F., CA 94122
NO CALIFORNIA SALES!!!

ORDER TODAY! 800-327-8544

CABLE descramblers (Jerrold) from \$40.00. Tocom VIP test chip. Fully activates unit. Also Zenith test board. Fully activates Z-Tacs. \$50.00. Call (213) 867-0081.

TOCOM VIP converters w/remote from \$279.00. Tocom super chips turn on everything, \$69.00 each. Phone (219) 935-4128.

PHOTOFACT folders under #1400 \$4.00. Others \$6.00. Postpaid. **LOEB**, 414 Chestnut Lane, East Meadow, NY 11554.

FREE CATALOG

FAMOUS "FIRESTIK" BRAND CB ANTENNAS
AND ACCESSORIES. QUALITY PRODUCTS
FOR THE SERIOUS CB'er. SINCE 1962

FIRESTIK ANTENNA COMPANY
2614 EAST ADAMS
PHOENIX, ARIZONA 85034

FM 2-way, CB/amateur, scanners, radar detectors, auto alarms, catalog \$1.00, RAYS, PO Box 14862, Fort Worth, TX 76117.

FREE catalog: Save hundreds on sought after electronic, electro mechanical, and computer related hardware and components — including hard-to-find items. Call toll free: 1 (800) 776-3700. **AMERICAN DESIGN COMPONENTS/Dept.** 119-031, 815 Fairview Avenue, Fairview, NJ 07022.

PRINTED circuit boards etched & drilled. Free delivery. **K & F ELECTRONICS, INC.**, 33041 Groesbeck, Fraser, MI 48026. (313) 294-8720.

T.V. notch filters, phone recording equipment, brochure \$1.00. MICRO Thinc., Box 63/6025, Margate, FL 33063. (305) 752-9202.

CLASSIFIED AD ORDER FORM

To run your own classified ad, put one word on each of the lines below and send this form along with your check to:

Radio-Electronics Classified Ads, 500-B Bi-County Boulevard, Farmingdale, NY 11735

PLEASE INDICATE in which category of classified advertising you wish your ad to appear. For special headings, there is a surcharge of **\$25.00**.

() Plans/Kits () Business Opportunities () For Sale
() Education/Instruction () Wanted () Satellite Television
()

Special Category: \$25.00

PLEASE PRINT EACH WORD SEPARATELY, IN BLOCK LETTERS.

(No refunds or credits for typesetting errors can be made unless you clearly print or type your copy.) Rates indicated are for standard style classified ads only. See below for additional charges for special ads. **Minimum: 15 words.**

1	2	3	4	5
6	7	8	9	10
11	12	13	14	15 (\$46.50)
16 (\$49.60)	17 (\$52.70)	18 (\$55.80)	19 (\$58.90)	20 (\$62.00)
21 (\$65.10)	22 (\$68.20)	23 (\$71.30)	24 (\$74.40)	25 (\$77.50)
26 (\$80.60)	27 (\$83.70)	28 (\$86.80)	29 (\$89.90)	30 (\$93.00)
31 (\$96.10)	32 (\$99.20)	33 (\$102.30)	34 (\$105.40)	35 (\$108.50)

We accept MasterCard and Visa for payment of orders. If you wish to use your credit card to pay for your ad fill in the following additional information (Sorry, no telephone orders can be accepted.):

Card Number

Expiration Date

Please Print Name

Signature

IF YOU USE A BOX NUMBER YOU MUST INCLUDE YOUR PERMANENT ADDRESS AND PHONE NUMBER FOR OUR FILES. ADS SUBMITTED WITHOUT THIS INFORMATION WILL NOT BE ACCEPTED.

CLASSIFIED COMMERCIAL RATE: (for firms or individuals offering commercial products or services) \$3.10 per word prepaid (no charge for zip code)...**MINIMUM 15 WORDS.** 5% discount for same ad in 6 issues; 10% discount for same ad in 12 issues within one year; if prepaid. **NON-COMMERCIAL RATE:** (for individuals who want to buy or sell a personal item) \$2.50 per word, prepaid...no minimum. **ONLY FIRST WORD AND NAME** set in bold caps at no extra charge. Additional bold face (not available as all caps) **55¢ per word additional.** Entire ad in boldface, \$3.70 per word. **TINT SCREEN BEHIND ENTIRE AD: \$3.85 per word. TINT SCREEN BEHIND ENTIRE AD PLUS ALL BOLD FACE AD: \$4.50 per word. EXPANDED TYPE AD: \$4.70 per word prepaid.** Entire ad in boldface, \$5.60 per word. **TINT SCREEN BEHIND ENTIRE EXPANDED TYPE AD: \$5.90 per word. TINT SCREEN BEHIND ENTIRE EXPANDED TYPE AD PLUS ALL BOLD FACE AD: \$6.80 per word. DISPLAY ADS:** 1" x 2 1/4"—\$410.00; 2" x 2 1/4"—\$820.00; 3" x 2 1/4"—\$1230.00. **General Information:** Frequency rates and prepayment discounts are available. **ALL COPY SUBJECT TO PUBLISHERS APPROVAL. ADVERTISEMENTS USING P.O. BOX ADDRESS WILL NOT BE ACCEPTED UNTIL ADVERTISER SUPPLIES PUBLISHER WITH PERMANENT ADDRESS AND PHONE NUMBER.** Copy to be in our hands on the 10th of the third month preceding the date of the issue. (i.e., Aug. issue copy must be received by May 10th). When normal closing date falls on Saturday, Sunday or Holiday, issue closes on preceding working day. Send for the classified brochure. Circle Number 49 on the Free Information Card.

CB RADIO OWNERS!

We specialize in a wide variety of technical information, parts and services for CB radios. 10-Meter and FM conversion kits, repair books, plans, high-performance accessories. Thousands of satisfied customers since 1976! Catalog \$2.

CBC INTERNATIONAL
P.O. BOX 31500RE, PHOENIX, AZ 85046

CABLE TV converters: Jerrold, Oak, Scientific Atlantic, Zenith & many others. "New MTS" stereo add-on: mute & volume. Ideal for 400 and 450 owners! 1 (800) 826-7623, Amex, Visa, M/C accepted. **B & B INC.**, 4030 Beau-D-Rue Drive, Eagan, MN 55122.

TUBES, new, up to 90% off, SASE, KIRBY, 298 West Carmel Drive, Carmel, IN 46032.

PROGRAMMABLE stepper motor drive & control for under \$100, IBM PC/XT compatible, **Commodore 64**, or other with 25 pin parallel port. PCB, interface & software. Send for detailed literature to: **MASE**, R.D. #2 Box 166, Mohrsville, PA 19541.



Quality Microwave TV Antennas

WIRELESS CABLE - IFTS - MMDS - Amateur TV
Ultra High Gain 50db (+) • Tuneable 1.9 to 2.7 Ghz.

- 36-Channel System Complete \$149.95
- 12-Channel System Complete \$114.95
- Call or write (SASE) for "FREE" Catalog

PHILLIPS-TECH ELECTRONICS
P.O. Box 8533 • Scottsdale, AZ 85252

(602) 947-7700 (\$3.00 Credit all phone orders)
MasterCard • Visa • COD's • Quantity Pricing

RESTRICTED technical information: Electronic surveillance, schematics, locksmithing, covert sciences, hacking, etc. **Huge selection. Free brochures.** **MENTOR-Z**, Drawer 1549, Asbury Park, NJ 07712.

CABLE TV converters and descramblers. We sell only the best. Low prices. **SB-3 \$79.00.** We ship C.O.D. Free catalog. **ACE PRODUCTS**, PO Box 582, Dept. E, Saco, ME 04072. 1 (800) 234-0726.

CABLE TV brokers and distributors high volume of descramblers Jerrold SB-3 refurbished or as is, converters Jerrold models DRX-400, JRX and hand remote control (no Canada sales for descramblers). Affitech, ask **DANIEL PERREAULT** (514) 656-9150.



TUBES - 2000 TYPES DISCOUNT PRICES!

Early, hard-to-find, and modern tubes. Also transformers, capacitors and parts for tube equipment. Send \$2.00 for 28 page wholesale catalog.

ANTIQUE ELECTRONIC SUPPLY

6221 S. Maple St. • Tempe, AZ 85238 • 602/820-5411

CB Tune-up manual Volume II & III. Specific model information for peaking 23's, and export CB's. \$19.95 each or (217) 466-4210 to order. Charge card, C.O.D. accepted. **THOMAS DISTRIBUTING**, 127-R Westwood, Paris, IL 61944.

CABLE TV secrets. Descramble cable signals in seven easy steps. Send \$9.50 SASE to **C AND W**, PO Box 893, Baytown, TX 77522-0893.

FREE lists, new merchandise, discounted prices! **New York Surplus Electronics Warehouse now open to the public!** Electronics, computer products, motors, power supplies, switches, transformers, speakers, semiconductors, etc. **ELECTRONIC COMPONENTS TRADING CORP.**, 44 V Jefryn Blvd., Deer Park, NY 11729. 1 (800) 942-9439, NY (516) 242-7733.

WIRELESS CABLE RECEIVERS 1.9 TO 2.7 GHz



30 CH PARABOLIC DISH SYSTEM \$173.90
30 CH ROD ANTENNA SYSTEM \$193.90
30 CH CRYSTAL CONTROLLED SYSTEM \$294.95
SUN MICROWAVE INT'L. INC. SEND \$1.00 FOR
P.O. BOX #34522 CATALOG ON THESE
PHOENIX, AZ. 85067 AND OTHER FINE
(602) 230-0640 VIDEO PRODUCTS
QUANTITY DISCOUNTS

VISA/MC/AMEX

ELECTRONIC supermarket great buys! surplus prices, IC's, DC motors, vacuum pump, transformers, PS, stepping-motors, builders, engineers, experimenters, LSASE, **FERTIK'S**, 5400 Ella, Phila., PA 19120.

CABLE TV converters & descramblers for Jerrold and Scientific Atlanta. Low prices, one year warranty. We ship COD. **BAY STATE ELECTRONICS**, PO Box 103, Boston, MA 02188. 1 (800) 359-9806.

ESTATE SALE. Collection of Radio-Electronics magazines going back to 1956. Too valuable to throw away. Write with best firm offer to: **MRS. ALICE I. OLSON**, 29465 Vista Plaza Drive, Laguna Niguel, CA 92677.

FLUKE SUPER SALE

Model 73 ... \$79	Model 83 ... \$199	VISA
75 ... \$119	85 ... \$229	MC
77 ... \$149	87 ... \$269	

▲ NEW! Model 45 ... \$79 ▼
KELVIN Electronics

7 Fairchild Ave., Plainville, NY 11803
(516) 349-7620 1(800) 645-9212



COMMUNICATIONS SECURITY ASSOCIATION

— Electronic surveillance, countersurveillance, communications security topics — membership information — POB 7069, Gaithersburg, MD 20898. BBS (202) 364-1304.

ROBOTICS software, PC/MSDOS. Explore computer vision, sonar sensing. Free brochure. **ROBOTS ETC**, Box 122, Tempe, AZ 85280.

TEST equipment pre-owned now at affordable prices. Signal generators from \$50.00, oscilloscopes from \$50.00, other equipment, including manuals available. Send \$2.00 U.S. for catalog, refunded on 1st order. **J.B. ELECTRONICS**, 3446 Dempster, Skokie, IL 60076. (708) 982-1973.

CAR stereos, equalizers, amplifiers, speakers, woofers, tweeters, speaker box supplies, alarms, DJ mixers, more. Large catalog \$1.00. **ELECTRISONIC-K1**, 8400 Alameda, El Paso, TX 79907.

CABLE TV, Tocom 5503 \$199.00, Oak RTC-56 \$150.00, Jerrold 400DIC \$125.00, Hamlin 6600 \$125.00, all with remote, Tri-Bi or SA-3-B \$79.00, C.O.D. orders welcome. Call **S.A.C.**, info (702) 647-3799. Orders 1 (800) 622-3799.

LOCKPICKS, car opening tools, surveillance equipment, protection devices, books, more! Catalog: \$3.00. **MICHAEL FREEMAN**, Box 179, Huntington, NY 11743.

CABLE converters, all major brands. Info + orders 1 (800) 782-0552. **FREEMAN, INC.**, SMP PO# 5036, Burnsville, MN 55337.

INTERFERENCE filters, all channels. Best quality, cylinder type. Best prices. Visa, MC, COD accepted. Large quantities available. **VIKING FILTERS**, 1 (800) 872-5912.

REVERSE utility meters! Phone phreaking! 125+ unusual publications! Catalog \$1.00. **ALTERNATIVES**, Box 4-R, Carthage, TX 75633.

TUBES, TV, radio and industrial. 10,000 stocked. Over 2,000 types available. Largest discounts. Free list. **CHUCK ADAMSON**, Box 640367, El Paso, TX 79904.

BOARDS! Cheap, easy, professional quality PCB making method. Silk screen PCB's. With less than \$20.00 worth of one time set up equipment, you can screen print 100's of different circuit board layouts. Fast, efficient, no costly chemicals. Money back guaranteed. Send \$20.00 to **BRIAN WOO**, 433 Springbank Drive, London, Ontario, N6J 1H2, Canada.

CABLE TV

TB-3 (Tri-Bi) or SA-3

Quantity Prices

10

20

\$48.

Each

\$43.

Each

50

100

\$39.

Each

\$35.

Each

Hours open 10:00 am to 4:00 pm Eastern time

Minimum order 5 units 55.00 ea.

Dealers wanted. We ship COD.

King Wholesale

1-800-729-0036

Fax number 6173400053

"No one beats the King's prices!"

DESCRAMBLERS

Try the

Radio Electronics

bulletin board system

(RE-BBS)
516-293-2283

The more you use it the more useful it becomes.

We support 300 and 1200 baud operation.

Parameters: 8N1 (8 data bits, no parity, 1 stop bit) or 7E1 (7 data bits, even parity, 1 stop bit).

Add yourself to our user files to increase your access.

Communicate with other R-E readers.

Leave your comments on R-E with the SYSOP.

RE-BBS
516-293-2283

CABLE TV DESCRAMBLER LIQUIDATION!

FREE CATALOG!

Hamlin Combos \$44, Oak M35B \$60 (min. 5), etc.

WEST COAST ELECTRONICS

For Information: 818-709-1758

Catalogs & Orders: 800-628-9656

TUBES Sylvania 6LQ6, 6L6GC, 20LF6 etc. Huge discounts. **ARLEN SUPPLY**, 7409 West Chester Pike, Upper Darby, PA 19082. 1 (800) 458-1301.

CABLE boxes: wholesale prices to all, Oak RTC-56 with remote \$150.00, Zenith Z-Tac \$225.00, Tocom 5503 with remote \$199.00, MLD-1200 Hamlin \$45.00, Jerrold-400 \$125.00, Tri-Bi super fast \$79.00, SA 3-B \$79.00, Oak M35B \$39.00, all other brands in stock, C.O.D. ok, same day shipping, quantity prices available call, **MOUNT HOOD ELECTRONICS**, (503) 253-0459.

PLANS AND KITS

CATALOG: hobby/broadcasting/HAM/CB: Cable TV, transmitters, amplifiers, surveillance devices, computers, more! PANAXIS, Box 130-F3, Paradise, CA 95967.

REMOTE CONTROL KEYCHAIN



Complete w/mini-transmitter and +5 vdc RF receiver Fully assembled including plans to build your own auto alarm. Quantity discounts available.

\$24.95 Check, Visa or M/C Add \$3 shipping

VISITECT INC. BOX 5442, SO. SAN FRAN., CA. 94080 (415) 872-0128 Fax (415) 872-2635

INVESTIGATORS, experimenters — Quality new plans. Micro and restricted devices. Free catalog. Self addressed stamped envelope required **KELLEY SECURITY INC.**, Suite 90, 2531 Sawtelle Blvd., Los Angeles, CA 90064.

CB Tricks II book. Power amplifier design and theory, UHF CB tune ups. Send \$19.95 **MEDICINE MAN CB**, PO Box 37, Clarksville, AR 72830.

LASER lighting entertainment systems and accessories. Create 3-dimensional laser light shows with these professional secrets! Electronic and mechanical designs for all budgets! \$20.00. **MILLENNIUM**, 229 McAfee, Thousand Oaks, CA 91360.

PRESENTING CABLE TV DESCRAMBLERS

STARRING
JERROLD, HAMLIN, OAK
AND OTHER FAMOUS MANUFACTURERS

- FINEST WARRANTY PROGRAM AVAILABLE
- LOWEST RETAIL / WHOLESALERS PRICES IN U.S.
- ORDERS SHIPPED FROM STOCK WITHIN 24 HRS.
- ALL MAJOR CREDIT CARDS ACCEPTED

FOR FREE CATALOG ONLY 1-800-345-8927
FOR ALL INFORMATION 1-818-709-9937

PACIFIC CABLE CO., INC.
7325 1/2 Reseda Blvd., Dept. 2100
Reseda, CA 91335

DESIGN your own custom circuits with our user friendly electronic engineering software. IBM and compatibles, Commodore 64, and 128. Free information. Write or call today! **WEASELGRAPHICS**, PO Box 51697, Riverside, CA 92517-2697. Phone 1 (800) 356-8113 Visa/Mastercard.

CABLE TV EQUIPMENT

Converters, Remote Controls, Descramblers, CD Players.



JERROLD-OAK-SCIENTIFIC ATLANTA-HAMLIN ZENITH MANY MORE CALL TODAY!

- ✓ Only quality products sold ✓ Easy to use
- ✓ Satisfaction guaranteed ✓ Knowledgeable sales staff
- ✓ Most orders shipped within 24 hours

CALL FOR YOUR FREE CATALOG

MC 1-800-228-7404 **VISA**

MAKE THE CONNECTION

WITH

NU-TEK ELECTRONICS

5114 Balcones Wood Dr.#307 Dept.298

Austin, TX. 78759

DAZER II personal protection device! Plans \$8.00. Lasers! Transmitters! Detectors! More! Kits or assembled! Catalog \$2.00. **QUANTUM RESEARCH**, 16645-113 Avenue, Edmonton, Alberta T5M 2X2.

DESCRAMBLING, new secret manual. Build your own descramblers for cable and subscription TV. Instructions, schematics for SSAVI, gated sync, sine wave, (HBO, Cinemax, Showtime, UHF, adult) \$12.95, \$2.00 postage. **CABLETRONICS**, Box 30502R, Bethesda, MD 20824.

MARK V ELECTRONICS, INC.

Competitive Pricing * Fast Shipping

Since 1985

ORDER IN CALIFORNIA 800-521-MARK

ORDER OUTSIDE CA 800-423-3483

FREE CATALOG & INFORMATION (213)888-8988

FAX (213) 888-6868

▲ indicates the level of difficulty in the assembling of our Products. ▲ Beginner ▲▲ Intermediate ▲▲▲ Advanced ★ Fully Assembled

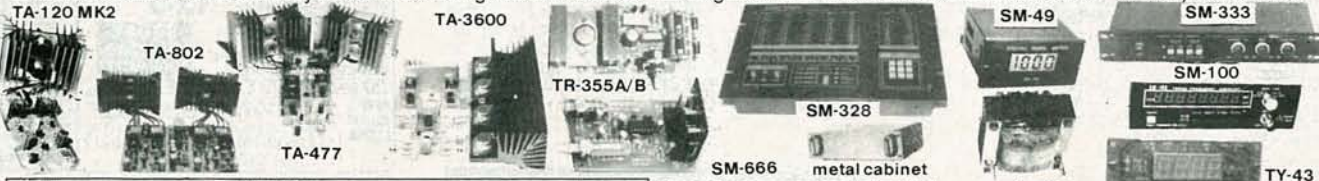

AMPLIFIERS		KIT	ASSEMB.
MODEL	DESCRIPTION		
TA-28MK2	Digital Voice Memo ▲▲	\$ 30.00	
TA-50A / B	Multi-Purpose Melody Generator ▲	12.84	17.20
TA-50C	Multi-Purpose Melody Generator ▲	13.65	18.71
TA-120MK2	35W Class "A" Main Power Mono Amp ▲▲	31.50	42.80
TA-300	30W Multi-Purpose Single Channel Amp ▲	20.00	29.00
SM-302	60W + 60W Stereo Power Amplifier (with Mic. input)▲▲		78.00
TA-323A	30W X 2 Stereo Pre-main Amp ▲	31.50	42.80
TA-377A	Hi-Quality FET Stereo Pre-Amp. ▲▲▲	59.95	75.00
TA-400	40W Solid State Mono Amp. ▲▲	28.00	34.93
TA-477	120W Mostlet Power Mono Amp. ▲▲	68.00	85.00
TA-800MK2	120W + 120W Low Tim Pre-Main Stereo Power Amp. ▲▲	63.92	
TA-802	80W + 80W DC Stereo Main Power Amp. ▲▲	45.94	59.72
TA-820A	60W + 60W OCL DC Pre-Main Stereo Amp. ▲▲	40.39	49.37
TA-1000A	100W Dynamic Class "A" Main Power Mono Amp. ▲▲	59.69	80.58
TA-1500	100W X 2 Class "A" DC Stereo Pre-Main Amp. ▲▲▲	73.70	95.81
TA-2200	Fet Super Class "A" DC Pre-Amp. ▲▲	47.70	58.24
TA-2400A	Electronic Echo & Reverberation Amp. ★		98.00
TA-2500	HQ Pre-Amp w/10 band graphic equalizer ★		68.00
TA-2800	Hi-FET IC Pre-Amp w/3 way tone control ▲	48.90	63.57
TA-3000	Stereo Simulator (For Mono TV or Any Mono Source) ▲▲	27.00	38.50
TA-3600	300W HQ Hi-Fi Power Mono Amp. ▲▲	85.00	110.00
POWER SUPPLIES		KIT	ASSEMB.
TR-100A	0-15V 2A Regulated DC Power Supply (W/Case)★	\$	\$ 69.50
TR-355A	0-15V 5A Regulated DC Power Supply ▲	15.65	21.76
TR-355B	0-30V 3A Regulated DC Power Supply ▲	15.65	21.76
TR-503	0-50V 3A Regulated DC Power Supply ▲▲	16.75	23.65
INSTRUMENTS		KIT	ASSEMB.
SM-43	3 1/2" Multi-Functional Led D.P.M. (w/ABS plastic case)▲▲	\$ 34.50	\$ 43.00
SM-48	4 1/2" Hi-Precision D.P.M.▲▲▲	38.00	48.00
SM-48A	4 1/2" Hi-Precision D.P.M. (w/ABS plastic case)▲▲▲	41.20	52.00
SM-49	3 1/2" Multi-Functional LCD D.P.M. (w/Hold Function)▲▲	36.00	44.50
SM-100	150MC Digital Frequency Counter▲▲▲	79.00	90.00
FC-1000A	1 GHz Frequency Counter ★		179.00

MISCELLANEOUS		KIT	ASSEMB.
MODEL	DESCRIPTION		
TY-23B	3 Channel Color Light Controller ★	\$	\$ 65.00
TY-25	Stereo Loudspeaker Protector ▲	14.85	20.85
TY-35	FM Wireless Microphone ▲	11.25	
TY-36	AC/DC Quartz Digital Clock ▲	19.00	26.20
TY-38	Sound / Touch Control Switch ▲	12.00	
TY-41MK V	Infrared Remote Control Unit (w/Case)▲▲▲	22.00	35.00
TY-42	Bar / Dot Level Meter ▲▲	24.15	33.81
TY-43	3 1/2" Digital Panel Meter ▲	29.00	38.00
TY-45	20 Steps Bar / Dot Audio Level Display ▲▲	38.45	46.14
TY-47	Superior Electronic Roulette ▲▲	19.46	27.24
SM-222	7 Band Hi-Fi Graphic Equalizer ▲▲▲	26.80	38.80
SM-328	4 Channel Professional Color Light Controller★		145.00
SM-333	Audio/Video Surround Sound Processor ▲▲▲▲	65.00	75.00
SM-666	Dynamic Noise Reduction ▲	26.00	34.00
SM-888	Universal Audio/Video KARAOKE Mixer. Pre-Amp. ★		225.00
10.000u/f	80 V Capacitor (Suggested for TA-3600, TA-477, TA-1000A & TA-802)		23.00
METAL CABINETS WITH ALUMINUM PANEL			PRICE
MODEL	H" x W" x D" MATCHING		
LG-1273	3" 12" 7" TA-2800, TA-377A, TA-2200		\$ 22.85
LG-1684	4" 16" 8" TA-323A, TA-377A, TA-2200		27.50
LG-1924	4" 19" 11 1/2" TA-802, TA-820A, TA-1500, TA-120MK 2, TA-800, TA-1000A		32.80
LG-1925	5" 19" 11 1/2" TA-477, TA-800, TA-1500, TA-1000A, TA-3600		35.80
LG-1983	2 1/2" 19" 8" TA-377A, TA-2800, TA-2200, TA-120MK 2		29.25
POWER TRANSFORMERS			PRICE
MODEL	DESCRIPTION	MATCHING	
001	28V x 2 6A to 30V x 2 6A	TA-800, TA-802, TA-820A, TA-1000A, TA-1500	\$ 27.00
002	36V x 2 3A	TR-503, TA-323A, TA-400, TA-300	22.00
003	40V x 2 6A	TA-477	28.00
004	24V x 2 6A	TA-120 MK 2	22.00
005	26V x 2 3A	TR-355B	16.00
006	18V x 2 5A	TR-355A	15.50
007	53V x 2 8A	TA-3600	43.00

We accept major Credit Cards, Money Orders, Check and C.O.D. Orders. C.O.D. fee is \$5.00. Minimum order is \$20.00. • We ship by UPS ground inside US (min. \$3.00) and ship by US mail Business & Showroom hours: (Pacific Time) outside US. Please call our sales department for orders over 2 lbs. or foreign orders. • All assembled units have a 30 days warranty. • Quality or Volume discount available upon request. • Residents Mon. thru Fri. 9:30 am to 5:00 pm of CA please add sales tax 6.75%. • All merchandise is subject to prior sale. Prices are subject to change without prior notice. We are not responsible for typographical errors. Sat. 10:00 am to 5:00 pm

MARK V ELECTRONICS, INC. - 8019 E. Slauson Ave, Montebello, CA 90640



CIRCLE 93 ON FREE INFORMATION CARD

MARCH 1991

Cable Descramblers

New Auto Tri-Bi guaranteed no flashing \$165.00

SB-3.....	\$99.00	ZENITH SUPER	
TRIMODE.....	\$109.00	SAAVI.....	\$199.00
HAMLIN.....	\$99.00	TOCOM.....	\$319.00
SCIENTIFIC.....		EAGLE.....	\$119.00
ATLANTA.....	\$119.00	COPY GUARD.....	\$59.95
OAK M35B.....	\$99.00	STARGATE 2000.....	\$88.00
ZENITH.....	\$175.00		

M.D. Electronics will match or beat any advertised wholesale or retail price.

Your best buys and warranties for cable converters and descramblers start with a FREE catalog from MD

For Information Call

402-554-0417

To order or request a free catalog

1-800-624-1150



M.D. ELECTRONICS

875 SO. 72nd St.
Omaha, NE 68114

BY ORDERING CABLE TV EQUIPMENT FROM M.D. ELECTRONICS THE PURCHASER AGREES TO COMPLY WITH ALL STATE AND FEDERAL LAWS REGARDING PRIVATE OWNERSHIP OF CABLE TV EQUIPMENT. IF YOU ARE UNSURE OF THESE LAWS CHECK WITH YOUR LOCAL OFFICIALS.



C.O.D.

CIRCLE 53 ON FREE INFORMATION CARD

EXCELLERATOR™ Series CABLE CONVERTERS WHEN QUALITY COUNTS



New Dynatrack™ fine tuning provides unmatched picture quality
550 Mhz tuner provides 83 channel capacity
Sleep timer for automatic shut off within 15-90 minutes
2/3 switchable HRC / IRC / Standard Switchable
2 Year warranty, Last channel recall, Favorite channel select, Scan
Double vented high efficiency transformer for cool performance
Stargate-2001 \$99.00
Stargate-550XL \$119.00 With Volume Control

Don't settle for anything less.

BUSINESS OPPORTUNITIES

MAKE \$50/hr working evenings or weekends in your own electronics business. Send for free facts. **INDUSTRY**, Box 531, Bronx, NY 10461-0208.

YOUR own radio station! AM, FM, TV, cable. Licensed/unlicensed. **BROADCASTING**, Box 130-F3, Paradise, CA 95967.

LET the government finance your small business. Grants/loans to \$500,000. Free recorded message: (707) 449-8600. (KS1).

ANTIQUE RADIO CLASSIFIED

Free Sample!

Antique Radio's

Largest Circulation Monthly.
Articles, Ads & Classifieds.

6-Month Trial: \$13. 1-Yr: \$24 (\$36-1st Class).
A.R.C., P.O. Box 802-L6, Carlisle, MA 01741

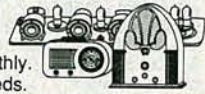

MAKE \$75,000 to \$250,000 yearly or more fixing IBM color monitors (and most brands). No investment. Start doing it from your home. (A telephone required.) Information, USA, Canada \$1.00 cash. US funds. other countries \$8.00. **RANDALL DISPLAY**, Box 2168-R, Van Nuys, CA 91404 USA.

LEARN to clean/repair fax machines. Huge new market! Earn \$85/hour. No experience necessary. Free details call 1 (800) 537-0589 or write to: **VIEJO PUBLICATIONS** 5329 Fountain Ave., #310, Dept. FX200, Los Angeles, CA 90029.

EASY work! Excellent pay! Assemble products at home. Call for information (504) 641-8003 Ext. 5192.

MAKE hot selling products! 30+ plans \$3.00, guaranteed. **NRG**, 11580 Okahurst Road, Largo, FL 34644.

MAKE \$\$\$! Become an American electronics dealer! Profit opportunities since 1965. Call **SCOTT PRUETT**, 1 (800) 872-1373.

PCB and schematic CAD software. Easy multilayer rubberband zoom pan and more. CGA EGA IBM compatibles. \$195.00. **NUMBER ONE SYSTEMS**, 10565 Bluebird Street, Coon Rapids, MN 55433. Demo Disc. (612) 757-8584.

SURVEILLANCE — Audio/video/infra-red/laser equipment. Industrial or private. 500 item catalog \$7.00. **SECURITY SYSTEMS**, 3017G Hudson, New Orleans, LA 70131.

BUILD from easy-to-follow schematics: audio mixers/equalizers (stage, studio, business, home, basic to sophisticated), feedback controllers, active filters, guitar super-fuzz box, loudspeaker enclosures (including car/van), power supplies, more. VSSE reliability. Send \$5.00 for descriptions. Reasonable prices. **VON SPRECKEN SOUND ENGINEERING**, Dept. B, Box 1315, Clinton, MS 39060.

CABLE DESCRAMBLERS OAK M35B COMBO \$39.95

Jerrold, Zenith, Hamlin, Sci. Atlanta, Pioneer & MORE! OUR PRICES ARE BELOW WHOLESALE!

CABLE+PLUS

14417 Chase St. #481-A Panorama City, CA 91402
1-800-822-9955 • Other Info. 1-818-785-4500
NO CALIF. SALES — DEALERS WANTED

PC/TV interface — RGB to TV/Video/VCR. Switchable between PC and composite video inputs. Channels 3 or 4, RF output. Complete PC card kits \$59.95. PC board only \$19.95. **INNOVATIONS CORP.**, 9 Bartlett St., Dept. 36, Andover, MA 01810.

NEW devices: proximity switch, static snooper, personal defender, laser supplies, bug snooper, PC interfaces and more. Catalogue \$2.00. **BAUER**, 35 Soucy, Delson, Quebec, J0L 1G0.

PROJECTION TV. Convert your TV to project 7 foot picture... Easy... Results comparable to \$2,500 projectors... **Plans and 8" lens \$27.95...** Professional systems available... Illustrated catalog free... **MACROCOMA**, 15GG Main Street, Washington Crossing, PA 18977. Creditcard orders 24 hours. (215) 736-3979.

ALARM schematic for home or auto. Excellent design with status LED's, time delay, and panic button. Easy to build and install. \$10.00: **NOBLE ELECTRONICS**, 17 Farmington Avenue, Suite 169, Plainville, CT 06062-1726.

FREE CATALOG! 1-800-648-7938

For all information 1-702-362-9026

JERROLD HAMLIN OAK ETC.

CABLE TV DESCRAMBLERS

• Compare our low Low Retail Prices!

• Guaranteed Prices & Warranties!

• Orders Shipped Immediately!

REPUBLIC CABLE PRODUCTS INC.

4080 Paradise Rd. #15 Dept. RE-90

Las Vegas, NV 89109

HOW TO use surface mount techniques. Build ultra miniature projects. Included free, two sets plans. Infra red remote control, and light display. Send \$15.00 to **CHARLIE'S VIDEO**, Dept. SMT, PO Box 7782, LaSierra, CA 92503.

HIGH-TECH speakers design any size by PC computer. \$20.00. **SACC**, PO Box 272825, Houston, TX 77277.

HYPNOTIZE or relax electronically! Alpha/meditation goggles. Complete kit \$53.00. Free information. **MARK WORLEY**, Box 261113, San Diego, CA 92196.

AC/DC VOLTAGE **PRO 400**
AC/DC CURRENT
DIODE TEST Stock No.
LOGIC TEST 990092 **\$69.95**
LED TEST GOOD/BAD
5 FREQ RANGES
5 CAPACITANCE RANGES
LOW BATTERY Warning
CONTINUITY TEST/BUZZER
TRANSISTOR CHECKER
20 MHZ FREQ COUNTER
30 DAY MONEY BACK GUARANTEE!

KELVIN Electronics VISA MC
7 Fairchild Ave., Plainview, NY 11803
(516) 349-7620 1(800) 645-9212
FAX (516) 349-7830

PROJECTION TV... Make \$\$\$'s assembling projectors... **Plans, 8" lens & dealers information \$25.50...** Professional systems available... Illustrated catalog free. **MACROCOMA**, 15GG Main Street, Washington Crossing, PA 18977... Creditcard orders 24 hrs. (215) 736-2880.

GOVERNMENT money! \$100,000s of available grants. New and existing business. Never repay. Information, \$1.00 (refundable). **FEDFUNDS**, 5959 Mission Gorge Road, Suite 106, Dept. RE, San Diego, CA 92120.

MAKE \$50/hr working evenings or weekends in your own electronics business. Send for free facts. **MJME INDUSTRY**, Box 531, Bronx, NY 10461-0208.

EDUCATION & INSTRUCTION

MAGIC! Four illustrated lessons plus inside information shows you how. We provide almost 50 tricks including equipment for four professional effects. You get a binder to keep the materials in, and a one-year membership in the International Performing Magicians with a plastic membership card that has your name gold-embossed. You get a one-year subscription to our quarterly newsletter "IT'S MAGIC!" Order now! \$29.95 for each course + \$3.50 postage and handling. (New York residents add applicable state and local sales tax). **THE MAGIC COURSE**, 500-B BiCounty Boulevard, Farmingdale, NY 11735.

F.C.C. Commercial General Radiotelephone license. Electronics home study. Fast, inexpensive! "Free" details. **COMMAND**, D-176, Box 2824, San Francisco, CA 94126.

LEARN IBM PC assembly language. 80 programs. Disk \$5.00. Book \$18.00. **ZIPFAST**, Box 12238, Lexington, KY 40581-2238.

ENTER THE WORLD OF PROFESSIONAL VIDEO! Pro's tell techniques and secrets of U-matic VCR's 32 pg. Illus. Send \$12.95 to **ANIBAL NEGRON**, 64 Mason Blvd., S.I., NY 10309.

BIOMEDICAL letter covers medical electronics, anatomy, equipment function, electrical safety, troubleshooting. **PNP**, POB 333, Brooklyn, NY 11204.

INTRODUCTION to data acquisition. Monitor switches. Control relays, lights, motors, etc. with your PC. Basic programs with explanations. Schematics. List of low cost data-acq manufacturers. Introductory level. Easy to learn \$10.00. **BEAM ELECTRONICS**, PO Box 44, Mount Nebo, WV 26679.

WANTED

INVENTIONS/ new products/ideas wanted: call **TLCI** for free information 1 (800) 468-7200 24 hours/day - USA/Canada.

WANTED - Panasonic AG-100 camcorder junker for parts. **MARVIN MOSS**, Box 28601, Atlanta, GA 30358.

INVENTORS: We submit ideas to industry. Find out what we can do for you. 1 (800) 288-IDEA.

NEED help with your electronic project, PCB assembly/artwork? Write to **T.S.**, PO Box 5275, Flint, MI 48505.

INVENTORS! Your first step is important. For free advice, call **ADVANCED PATENT SERVICES**, Washington, DC, 1 (800) 458-0352.

PAY TV AND SATELLITE DESCRAMBLING ALL NEW 1991 EDITION

The very best of the Pay TV series. The very latest in build-your-own, turn-ons, bypasses, ECM's etc., for cable wireless and satellite including VCI+ and B-MAC. Only \$14.95. Volume 1 (basics) \$14.95. 1989 Edition \$14.95. Build Satellite Systems Under \$600. \$12.95 Wireless Cable Handbook \$9.95. Any 3/\$29 or 5/\$42. Scrambling News Monthly, Articles, Circuits, Sources. News and more. \$19.95/yr. Sample \$3. New catalog \$1. COD's are OK.

SCRAMBLING NEWS, 1552 Hertel Ave.,
Buffalo, NY, 14216. 716-874-2088

SATELLITE TV

VIDEOCIPHER II manuals. **Volume 1** - Hardware, **Volume 2** - Software - either \$34.95. **Volume 3** - Projects/Software, **Volume 5** - Documentation or **Volume 6** - Experimentation \$44.95 each. **Volume 7** - 032/Hacking \$54.95. **Volume 4** - Repair \$99.95. **VC Primer** - \$9.95. **Scanner Hacker's Bible** - \$34.95. **Cable Hacker's Bible** - \$34.95. **Clone Hacker's Bible** - \$34.95. Catalog - \$3.00. COD's (602) 782-2316. **TELECODE**, PO Box 6426-RE, Yuma, AZ 85366-6426.

FREE catalog - Lowest prices worldwide, save 40 - 60%. Systems, upgrades, parts, all major brands factory fresh and warranted. **SKYVISION**, 2009 Collegeway, Fergus Falls, MN 56537. 1 (800) 334-6455.

CABLE TV secrets - the outlaw publication the cable companies tried to ban. HBO, Movie Channel, Showtime, descramblers, converters, etc. Suppliers list included. \$9.95. **CABLE FACTS**, Box 711-R, Pataskala, OH 43062.

VIDEOCIPHER II descrambling manual. Schematics, video and audio. Explains DES, Eprom, Clonemaster, 3Musketeer, Pay-per-view (HBO, Cinemax, Showtime, adult, etc.) \$16.95, \$2.00 postage. Schematics for Videocypher Plus, \$20.00. Schematics for Videocypher 032, \$15.00. Collection of software to copy and alter Eprom codes, \$25.00. **CABLETRONICS**, Box 30502R, Bethesda, MD 20824.

CABLE T.V. CONVERTERS WHY PAY A HIGH MONTHLY FEE?



All Jerrold, Oak, Hamlin, Zenith, Scientific Atlanta, Magnavox and all specialized cable equipment available for shipment within 24 hours. For fast service MC / VISA or C.O.D. telephone orders accepted (800) 648-3030 60 Day Guarantee (Quantity Discounts) 8 A.M. to 5 P.M. C.S.T. **CLOSED WEEK-ENDS.** Send self-addressed Stamped envelope (60¢ postage) for Catalog.

MIDWEST ELECTRONICS INC. P.O. Box 5000
Suite 311 (R)
Carpentersville, IL 60110

No Illinois Orders Accepted.

VENTURE CAPITAL

VENTURE capital sources (908) 753-1964. **OSDC**, 1308 Centennial Avenue, Suite 194, Piscataway, NJ 08854-4327.

INVENTORS

INVENTORS! Can you patent and profit from your idea? Call **AMERICAN INVENTORS CORPORATION** for free information. Over a decade of service 1 (800) 338-5656. In Canada call (413) 568-3753.

MCM ELECTRONICS Answers to The Law of Supply and Demand

You Demand.



We Supply.

You demand a huge selection of high-quality audio, video and computer parts and components, shipped quickly without backorders—support from a staff of knowledgeable sales reps—phone-in technical assistance when you need it—and convenient payment terms. **NO PROBLEM...** when MCM is YOUR electronic resource. For A **FREE, ONE-YEAR SUBSCRIPTION** to our "POWERHOUSE" Catalog and unbeatable service, Call **TOLL-FREE 1-800-543-4330!**



MCM ELECTRONICS
650 CONGRESS PARK DR.
CENTERVILLE, OH 45459-4072
A PREMIER Company

SOURCE NO. RE-69

CIRCLE 87 ON FREE INFORMATION CARD

MARCH 1991

ASK R-E

continued from page 12

against a standard value. Any differences produce an error voltage that's used to control the speed of the cassette recorder. That type of circuitry usually uses a small potentiometer as a voltage divider to provide the reference voltage to the speed control circuit. Changing the speed of the recorder is simply a matter of adjusting the pot.

The hook here is that, while it might be easy to adjust a potentiometer, you can't do that until you first know where it is—and that's where the need for the service manual comes in. If your cassette recorder doesn't use that method to control the speed, you'll have to locate the power leads to the motor and add a bit of circuitry to control the motor voltage. That's not hard to do and only requires, as you suggested, a few components.

There are several small circuits you can use to control the speed of a small DC motor and one of them is shown in Fig. 1. Before you start modifying the cassette recorder however,

make sure you understand the circuitry. While it's possible to do without the service manual to locate the speed control, it's very risky to start cutting wires and adding components unless you know exactly which wires to cut and which ones to leave alone.

BASIC DIFFERENCES

I recently became the owner of an IBM computer and, after setting it up, I noticed that there are two BASIC programs included with the DOS disk. One is called BASIC and the other is called BASICA. Could you explain the difference between them?— G. Benjamin, Fischer, NY

There are actually three versions of BASIC but the differences between them are really only of historical interest since each succeeding one is a superset of the previous ones.

The simplest BASIC was cassette BASIC, which was originally burned in EPROM's (or their equivalents) on the motherboard. That practice ended with the introduction of the AT-class machines. If you have a real XT made by IBM, chances are that cas-

sette basic is sitting in chips on your motherboard. XT clone machines provided sockets for EPROM's but, since BASIC was protected by an IBM copyright, the sockets were never filled. That was left up to you.

The intermediate version of the language contained commands to use the disk drives and was referred to as Disk BASIC. That's the BASIC file you found on your DOS disk.

The most advanced of the three versions is BASICA—the "A" stands for "Advanced." It has all the commands available in the other versions as well as other commands related to trig, math, and graphics.

I believe that IBM has finally stopped including both BASIC and BASICA on their DOS distribution disks but that was even after the introduction of DOS 3.2. Current versions of DOS only include the more advanced BASICA.

I hope you don't expect me to give you a reason why IBM kept both versions of the language on their distribution disks for so long. Quite frankly, I don't have any idea whatsoever and was hoping that either you or some other reader knew why. **R-E**



2-1/2" SANYO TWEETER

Paper cone with gold tone dust cap. 8 oz. magnet. 8 ohm. 1/2" ferro fluid voice coil. Power handling: 50W RMS, 70W max. Frequency response: 3K-20KHz.



#RD-271-020 \$1⁹⁵ \$1⁷⁵ 95c
(1-9) (10-59) (60-up)

SUPER HORN TWEETER

Original piezo tweeter made by Motorola. SPL=94 dB 2.83V/1M. Response: 4KHz-27KHz. Handles approximately 50 watts.



#RD-270-010 \$5³⁰ \$4⁵⁰ \$3⁹⁵
(1-9) (10-79) (80-up)

2" DOME MIDRANGE

Textile dome midrange made by Philips. 8 ohm. SPL=90 dB 1W/1M. 30W RMS, 40W max. Response: 550-5KHz.



#RD-280-210 \$27³⁰ \$25⁷⁰
(1-3) (4-up)

15" SUBWOOFER



Dual voice coil. 40 oz. magnet. 6 ohm imp. 100W RMS, 140W max. Response: 20-1.2KHz. Resonant frequency: 21Hz. SPL=93 dB 1W/1M.

#RD-290-190 \$54⁵⁰ \$49⁹⁰
(1-3) (4-up)

SUBWOOFER COVER



200W RMS crossover designed specifically for use with dual voice coil sub woofers. 12 dB per octave roll-off at 150Hz.

#RD-260-220 \$28⁸⁰ \$24⁴⁰

10" POLY WOOFER

Medium duty. 60W RMS, 80W max. 14 oz. magnet. Response: 25-2.5KHz. fs=28Hz.



#RD-290-096 \$18⁹⁰ \$16⁹⁰
(1-3) (4-up)

TITANIUM COMPOSITE TWEETER

The advantages of both hard and soft dome technologies. 8 ohm. Ferro fluid cooled voice coil. SPL=90 dB 1W/1M 50W RMS, 70W max. 4" round. Polydax #DTW100T125.



#RD-270-047 \$27⁵⁰ \$24⁹⁰
(1-9) (10-up)

SPEAKER BUILDING BOOK

Revised edition of David Weems' best selling book. Learn to build low cost speakers that rival the high priced models.



#RD-500-021 \$16⁹⁵

12" CAST FRAME WOOFER



12" woofer made in the USA by Eminence. Paper cone and dust cap with treated cloth surround. 80 oz. magnet. 2-1/2" vented voice coil. 8 ohm. 170W RMS, 235W max. 40-4.5KHz response.

#RD-290-147 \$72⁹⁰ \$69⁵⁰
(1-3) (4-up)



FREE CATALOG

Parts Express International Inc.
340 E. First St., Dayton, Ohio 45402
Local: 1-513-222-0173
FAX: 513-222-4644

• 15 day money back guarantee • \$15.00 minimum order • We accept Mastercard, Visa, Discover, and C.O.D. orders. • 24 hour shipping • Shipping charge = UPS chart rate + \$1.00 (\$3.00 minimum charge) • Hours 8:30 am- 7:00 pm EST, Monday - Friday • Mail order customers, please call for shipping estimate on orders exceeding 5 lbs. Foreign customers please send \$5.00 U.S. funds for catalog postage.

CALL TOLL FREE
1-800-338-0531

CIRCLE 56 ON FREE INFORMATION CARD

ZENITHS & TOCOMS

SUPER Zenith (Z-TAC) converters (flashing)... \$169.00. Zenith "turn-on" module... \$49.00. Tocom 5503(A) & 5504 converters... \$139.00. Tocom (add-on) descramblers... \$79.00. Tocom (5503-VIP & 5507) "turn-on" chips... \$49.00. CIN-EPLEX VIDEO GROUP. 1 (800) 726-4627.

VISA CALL NOW MC

FREE 1991 CATALOG

TEST/MEASUREMENT EQUIPMENT
COMPUTER PRODUCTS
COMPONENTS

APPLIED ELECTRONIC RESEARCH, INC.
4701 SW 45th St., Deerfield, FL 33414
FAX (305) 987-5996 TEL (305) 987-9785

Cable TV Descramblers

If you find a better deal, we'll better our deal.

"Jerrold" "Tocom" "Hamlin" "Oak" "Scientific Atlanta" "Zenith"
Ask about our extended warranty program.

COD, Visa, M/C welcome.
Free Call - Free Catalog.

Video Tech **800-562-6884**

3702 S. Virginia St., Ste. 160-304
Reno, NV 89502.



CABLE TV "BOXES"

Converters - Descramblers
Remote Controls - Accessories

- ★ Guaranteed Best Prices ★
- ★ 1 Year Warranty - C.O.D.'s ★
- ★ Immediate Shipping ★
- ★ FREE CATALOG ★

Call or Write
TRANS-WORLD CABLE CO.
12062 Southwest 117th Court, Suite 126
Miami, Florida 33186
1-800-442-9333



STATEMENT OF OWNERSHIP, MANAGEMENT AND CIRCULATION

1. Name of Publication: RADIO-ELECTRONICS

2. Issue Date: 11/4/89

3. Issue Frequency: Monthly

4. Annual Subscription Price: \$17.97

5. Office of Publication: 588-B 81-COUNTY BLVD., FARMINGDALE, NY 11735

6. Owner: CONSUMER & INDUSTRIAL ELECTRONICS, INC.

7. Executive Director: LARRY STEINER

8. Business Address: 588-B 81-COUNTY BLVD., FARMINGDALE, NY 11735

9. Home Office Address: 588-B 81-COUNTY BLVD., FARMINGDALE, NY 11735

10. Full Name and Complete Mailing Address of Publisher: CONSUMER & INDUSTRIAL ELECTRONICS, INC., 588-B 81-COUNTY BLVD., FARMINGDALE, NY 11735

11. Full Name and Complete Mailing Address of Editor: LARRY STEINER, 588-B 81-COUNTY BLVD., FARMINGDALE, NY 11735

12. Full Name and Complete Mailing Address of Business Manager: CONSUMER & INDUSTRIAL ELECTRONICS, INC., 588-B 81-COUNTY BLVD., FARMINGDALE, NY 11735

13. Full Name and Complete Mailing Address of Circulation Director: CONSUMER & INDUSTRIAL ELECTRONICS, INC., 588-B 81-COUNTY BLVD., FARMINGDALE, NY 11735

14. Full Name and Complete Mailing Address of Advertising Manager: CONSUMER & INDUSTRIAL ELECTRONICS, INC., 588-B 81-COUNTY BLVD., FARMINGDALE, NY 11735

15. Full Name and Complete Mailing Address of General Manager: CONSUMER & INDUSTRIAL ELECTRONICS, INC., 588-B 81-COUNTY BLVD., FARMINGDALE, NY 11735

16. Full Name and Complete Mailing Address of President: CONSUMER & INDUSTRIAL ELECTRONICS, INC., 588-B 81-COUNTY BLVD., FARMINGDALE, NY 11735

17. Full Name and Complete Mailing Address of Vice President: CONSUMER & INDUSTRIAL ELECTRONICS, INC., 588-B 81-COUNTY BLVD., FARMINGDALE, NY 11735

18. Full Name and Complete Mailing Address of Treasurer: CONSUMER & INDUSTRIAL ELECTRONICS, INC., 588-B 81-COUNTY BLVD., FARMINGDALE, NY 11735

19. Full Name and Complete Mailing Address of Secretary: CONSUMER & INDUSTRIAL ELECTRONICS, INC., 588-B 81-COUNTY BLVD., FARMINGDALE, NY 11735

20. Full Name and Complete Mailing Address of Controller: CONSUMER & INDUSTRIAL ELECTRONICS, INC., 588-B 81-COUNTY BLVD., FARMINGDALE, NY 11735

21. Full Name and Complete Mailing Address of Assistant Secretary: CONSUMER & INDUSTRIAL ELECTRONICS, INC., 588-B 81-COUNTY BLVD., FARMINGDALE, NY 11735

22. Full Name and Complete Mailing Address of Assistant Controller: CONSUMER & INDUSTRIAL ELECTRONICS, INC., 588-B 81-COUNTY BLVD., FARMINGDALE, NY 11735

23. Full Name and Complete Mailing Address of Assistant Treasurer: CONSUMER & INDUSTRIAL ELECTRONICS, INC., 588-B 81-COUNTY BLVD., FARMINGDALE, NY 11735

24. Full Name and Complete Mailing Address of Assistant Secretary: CONSUMER & INDUSTRIAL ELECTRONICS, INC., 588-B 81-COUNTY BLVD., FARMINGDALE, NY 11735

25. Full Name and Complete Mailing Address of Assistant Controller: CONSUMER & INDUSTRIAL ELECTRONICS, INC., 588-B 81-COUNTY BLVD., FARMINGDALE, NY 11735

26. Full Name and Complete Mailing Address of Assistant Treasurer: CONSUMER & INDUSTRIAL ELECTRONICS, INC., 588-B 81-COUNTY BLVD., FARMINGDALE, NY 11735

27. Full Name and Complete Mailing Address of Assistant Secretary: CONSUMER & INDUSTRIAL ELECTRONICS, INC., 588-B 81-COUNTY BLVD., FARMINGDALE, NY 11735

28. Full Name and Complete Mailing Address of Assistant Controller: CONSUMER & INDUSTRIAL ELECTRONICS, INC., 588-B 81-COUNTY BLVD., FARMINGDALE, NY 11735

29. Full Name and Complete Mailing Address of Assistant Treasurer: CONSUMER & INDUSTRIAL ELECTRONICS, INC., 588-B 81-COUNTY BLVD., FARMINGDALE, NY 11735

30. Full Name and Complete Mailing Address of Assistant Secretary: CONSUMER & INDUSTRIAL ELECTRONICS, INC., 588-B 81-COUNTY BLVD., FARMINGDALE, NY 11735

31. Full Name and Complete Mailing Address of Assistant Controller: CONSUMER & INDUSTRIAL ELECTRONICS, INC., 588-B 81-COUNTY BLVD., FARMINGDALE, NY 11735

32. Full Name and Complete Mailing Address of Assistant Treasurer: CONSUMER & INDUSTRIAL ELECTRONICS, INC., 588-B 81-COUNTY BLVD., FARMINGDALE, NY 11735

33. Full Name and Complete Mailing Address of Assistant Secretary: CONSUMER & INDUSTRIAL ELECTRONICS, INC., 588-B 81-COUNTY BLVD., FARMINGDALE, NY 11735

34. Full Name and Complete Mailing Address of Assistant Controller: CONSUMER & INDUSTRIAL ELECTRONICS, INC., 588-B 81-COUNTY BLVD., FARMINGDALE, NY 11735

35. Full Name and Complete Mailing Address of Assistant Treasurer: CONSUMER & INDUSTRIAL ELECTRONICS, INC., 588-B 81-COUNTY BLVD., FARMINGDALE, NY 11735

36. Full Name and Complete Mailing Address of Assistant Secretary: CONSUMER & INDUSTRIAL ELECTRONICS, INC., 588-B 81-COUNTY BLVD., FARMINGDALE, NY 11735

37. Full Name and Complete Mailing Address of Assistant Controller: CONSUMER & INDUSTRIAL ELECTRONICS, INC., 588-B 81-COUNTY BLVD., FARMINGDALE, NY 11735

38. Full Name and Complete Mailing Address of Assistant Treasurer: CONSUMER & INDUSTRIAL ELECTRONICS, INC., 588-B 81-COUNTY BLVD., FARMINGDALE, NY 11735

39. Full Name and Complete Mailing Address of Assistant Secretary: CONSUMER & INDUSTRIAL ELECTRONICS, INC., 588-B 81-COUNTY BLVD., FARMINGDALE, NY 11735

40. Full Name and Complete Mailing Address of Assistant Controller: CONSUMER & INDUSTRIAL ELECTRONICS, INC., 588-B 81-COUNTY BLVD., FARMINGDALE, NY 11735

41. Full Name and Complete Mailing Address of Assistant Treasurer: CONSUMER & INDUSTRIAL ELECTRONICS, INC., 588-B 81-COUNTY BLVD., FARMINGDALE, NY 11735

42. Full Name and Complete Mailing Address of Assistant Secretary: CONSUMER & INDUSTRIAL ELECTRONICS, INC., 588-B 81-COUNTY BLVD., FARMINGDALE, NY 11735

43. Full Name and Complete Mailing Address of Assistant Controller: CONSUMER & INDUSTRIAL ELECTRONICS, INC., 588-B 81-COUNTY BLVD., FARMINGDALE, NY 11735

44. Full Name and Complete Mailing Address of Assistant Treasurer: CONSUMER & INDUSTRIAL ELECTRONICS, INC., 588-B 81-COUNTY BLVD., FARMINGDALE, NY 11735

45. Full Name and Complete Mailing Address of Assistant Secretary: CONSUMER & INDUSTRIAL ELECTRONICS, INC., 588-B 81-COUNTY BLVD., FARMINGDALE, NY 11735

46. Full Name and Complete Mailing Address of Assistant Controller: CONSUMER & INDUSTRIAL ELECTRONICS, INC., 588-B 81-COUNTY BLVD., FARMINGDALE, NY 11735

47. Full Name and Complete Mailing Address of Assistant Treasurer: CONSUMER & INDUSTRIAL ELECTRONICS, INC., 588-B 81-COUNTY BLVD., FARMINGDALE, NY 11735

48. Full Name and Complete Mailing Address of Assistant Secretary: CONSUMER & INDUSTRIAL ELECTRONICS, INC., 588-B 81-COUNTY BLVD., FARMINGDALE, NY 11735

49. Full Name and Complete Mailing Address of Assistant Controller: CONSUMER & INDUSTRIAL ELECTRONICS, INC., 588-B 81-COUNTY BLVD., FARMINGDALE, NY 11735

50. Full Name and Complete Mailing Address of Assistant Treasurer: CONSUMER & INDUSTRIAL ELECTRONICS, INC., 588-B 81-COUNTY BLVD., FARMINGDALE, NY 11735

51. Full Name and Complete Mailing Address of Assistant Secretary: CONSUMER & INDUSTRIAL ELECTRONICS, INC., 588-B 81-COUNTY BLVD., FARMINGDALE, NY 11735

52. Full Name and Complete Mailing Address of Assistant Controller: CONSUMER & INDUSTRIAL ELECTRONICS, INC., 588-B 81-COUNTY BLVD., FARMINGDALE, NY 11735

53. Full Name and Complete Mailing Address of Assistant Treasurer: CONSUMER & INDUSTRIAL ELECTRONICS, INC., 588-B 81-COUNTY BLVD., FARMINGDALE, NY 11735

54. Full Name and Complete Mailing Address of Assistant Secretary: CONSUMER & INDUSTRIAL ELECTRONICS, INC., 588-B 81-COUNTY BLVD., FARMINGDALE, NY 11735

55. Full Name and Complete Mailing Address of Assistant Controller: CONSUMER & INDUSTRIAL ELECTRONICS, INC., 588-B 81-COUNTY BLVD., FARMINGDALE, NY 11735

56. Full Name and Complete Mailing Address of Assistant Treasurer: CONSUMER & INDUSTRIAL ELECTRONICS, INC., 588-B 81-COUNTY BLVD., FARMINGDALE, NY 11735

57. Full Name and Complete Mailing Address of Assistant Secretary: CONSUMER & INDUSTRIAL ELECTRONICS, INC., 588-B 81-COUNTY BLVD., FARMINGDALE, NY 11735

58. Full Name and Complete Mailing Address of Assistant Controller: CONSUMER & INDUSTRIAL ELECTRONICS, INC., 588-B 81-COUNTY BLVD., FARMINGDALE, NY 11735

59. Full Name and Complete Mailing Address of Assistant Treasurer: CONSUMER & INDUSTRIAL ELECTRONICS, INC., 588-B 81-COUNTY BLVD., FARMINGDALE, NY 11735

60. Full Name and Complete Mailing Address of Assistant Secretary: CONSUMER & INDUSTRIAL ELECTRONICS, INC., 588-B 81-COUNTY BLVD., FARMINGDALE, NY 11735

61. Full Name and Complete Mailing Address of Assistant Controller: CONSUMER & INDUSTRIAL ELECTRONICS, INC., 588-B 81-COUNTY BLVD., FARMINGDALE, NY 11735

62. Full Name and Complete Mailing Address of Assistant Treasurer: CONSUMER & INDUSTRIAL ELECTRONICS, INC., 588-B 81-COUNTY BLVD., FARMINGDALE, NY 11735

63. Full Name and Complete Mailing Address of Assistant Secretary: CONSUMER & INDUSTRIAL ELECTRONICS, INC., 588-B 81-COUNTY BLVD., FARMINGDALE, NY 11735

64. Full Name and Complete Mailing Address of Assistant Controller: CONSUMER & INDUSTRIAL ELECTRONICS, INC., 588-B 81-COUNTY BLVD., FARMINGDALE, NY 11735

65. Full Name and Complete Mailing Address of Assistant Treasurer: CONSUMER & INDUSTRIAL ELECTRONICS, INC., 588-B 81-COUNTY BLVD., FARMINGDALE, NY 11735

66. Full Name and Complete Mailing Address of Assistant Secretary: CONSUMER & INDUSTRIAL ELECTRONICS, INC., 588-B 81-COUNTY BLVD., FARMINGDALE, NY 11735

67. Full Name and Complete Mailing Address of Assistant Controller: CONSUMER & INDUSTRIAL ELECTRONICS, INC., 588-B 81-COUNTY BLVD., FARMINGDALE, NY 11735

68. Full Name and Complete Mailing Address of Assistant Treasurer: CONSUMER & INDUSTRIAL ELECTRONICS, INC., 588-B 81-COUNTY BLVD., FARMINGDALE, NY 11735

69. Full Name and Complete Mailing Address of Assistant Secretary: CONSUMER & INDUSTRIAL ELECTRONICS, INC., 588-B 81-COUNTY BLVD., FARMINGDALE, NY 11735

70. Full Name and Complete Mailing Address of Assistant Controller: CONSUMER & INDUSTRIAL ELECTRONICS, INC., 588-B 81-COUNTY BLVD., FARMINGDALE, NY 11735

71. Full Name and Complete Mailing Address of Assistant Treasurer: CONSUMER & INDUSTRIAL ELECTRONICS, INC., 588-B 81-COUNTY BLVD., FARMINGDALE, NY 11735

72. Full Name and Complete Mailing Address of Assistant Secretary: CONSUMER & INDUSTRIAL ELECTRONICS, INC., 588-B 81-COUNTY BLVD., FARMINGDALE, NY 11735

73. Full Name and Complete Mailing Address of Assistant Controller: CONSUMER & INDUSTRIAL ELECTRONICS, INC., 588-B 81-COUNTY BLVD., FARMINGDALE, NY 11735

74. Full Name and Complete Mailing Address of Assistant Treasurer: CONSUMER & INDUSTRIAL ELECTRONICS, INC., 588-B 81-COUNTY BLVD., FARMINGDALE, NY 11735

75. Full Name and Complete Mailing Address of Assistant Secretary: CONSUMER & INDUSTRIAL ELECTRONICS, INC., 588-B 81-COUNTY BLVD., FARMINGDALE, NY 11735

76. Full Name and Complete Mailing Address of Assistant Controller: CONSUMER & INDUSTRIAL ELECTRONICS, INC., 588-B 81-COUNTY BLVD., FARMINGDALE, NY 11735

77. Full Name and Complete Mailing Address of Assistant Treasurer: CONSUMER & INDUSTRIAL ELECTRONICS, INC., 588-B 81-COUNTY BLVD., FARMINGDALE, NY 11735

78. Full Name and Complete Mailing Address of Assistant Secretary: CONSUMER & INDUSTRIAL ELECTRONICS, INC., 588-B 81-COUNTY BLVD., FARMINGDALE, NY 11735

79. Full Name and Complete Mailing Address of Assistant Controller: CONSUMER & INDUSTRIAL ELECTRONICS, INC., 588-B 81-COUNTY BLVD., FARMINGDALE, NY 11735

80. Full Name and Complete Mailing Address of Assistant Treasurer: CONSUMER & INDUSTRIAL ELECTRONICS, INC., 588-B 81-COUNTY BLVD., FARMINGDALE, NY 11735

81. Full Name and Complete Mailing Address of Assistant Secretary: CONSUMER & INDUSTRIAL ELECTRONICS, INC., 588-B 81-COUNTY BLVD., FARMINGDALE, NY 11735

82. Full Name and Complete Mailing Address of Assistant Controller: CONSUMER & INDUSTRIAL ELECTRONICS, INC., 588-B 81-COUNTY BLVD., FARMINGDALE, NY 11735

83. Full Name and Complete Mailing Address of Assistant Treasurer: CONSUMER & INDUSTRIAL ELECTRONICS, INC., 588-B 81-COUNTY BLVD., FARMINGDALE, NY 11735

84. Full Name and Complete Mailing Address of Assistant Secretary: CONSUMER & INDUSTRIAL ELECTRONICS, INC., 588-B 81-COUNTY BLVD., FARMINGDALE, NY 11735

85. Full Name and Complete Mailing Address of Assistant Controller: CONSUMER & INDUSTRIAL ELECTRONICS, INC., 588-B 81-COUNTY BLVD., FARMINGDALE, NY 11735

86. Full Name and Complete Mailing Address of Assistant Treasurer: CONSUMER & INDUSTRIAL ELECTRONICS, INC., 588-B 81-COUNTY BLVD., FARMINGDALE, NY 11735

87. Full Name and Complete Mailing Address of Assistant Secretary: CONSUMER & INDUSTRIAL ELECTRONICS, INC., 588-B 81-COUNTY BLVD., FARMINGDALE, NY 11735

88. Full Name and Complete Mailing Address of Assistant Controller: CONSUMER & INDUSTRIAL ELECTRONICS, INC., 588-B 81-COUNTY BLVD., FARMINGDALE, NY 11735

89. Full Name and Complete Mailing Address of Assistant Treasurer: CONSUMER & INDUSTRIAL ELECTRONICS, INC., 588-B 81-COUNTY BLVD., FARMINGDALE, NY 11735

90. Full Name and Complete Mailing Address of Assistant Secretary: CONSUMER & INDUSTRIAL ELECTRONICS, INC., 588-B 81-COUNTY BLVD., FARMINGDALE, NY 11735

91. Full Name and Complete Mailing Address of Assistant Controller: CONSUMER & INDUSTRIAL ELECTRONICS, INC., 588-B 81-COUNTY BLVD., FARMINGDALE, NY 11735

92. Full Name and Complete Mailing Address of Assistant Treasurer: CONSUMER & INDUSTRIAL ELECTRONICS, INC., 588-B 81-COUNTY BLVD., FARMINGDALE, NY 11735

93. Full Name and Complete Mailing Address of Assistant Secretary: CONSUMER & INDUSTRIAL ELECTRONICS, INC., 588-B 81-COUNTY BLVD., FARMINGDALE, NY 11735

94. Full Name and Complete Mailing Address of Assistant Controller: CONSUMER & INDUSTRIAL ELECTRONICS, INC., 588-B 81-COUNTY BLVD., FARMINGDALE, NY 11735

95. Full Name and Complete Mailing Address of Assistant Treasurer: CONSUMER & INDUSTRIAL ELECTRONICS, INC., 588-B 81-COUNTY BLVD., FARMINGDALE, NY 11735

96. Full Name and Complete Mailing Address of Assistant Secretary: CONSUMER & INDUSTRIAL ELECTRONICS, INC., 588-B 81-COUNTY BLVD., FARMINGDALE, NY 11735

97. Full Name and Complete Mailing Address of Assistant Controller: CONSUMER & INDUSTRIAL ELECTRONICS, INC., 588-B 81-COUNTY BLVD., FARMINGDALE, NY 11735

98. Full Name and Complete Mailing Address of Assistant Treasurer: CONSUMER & INDUSTRIAL ELECTRONICS, INC., 588-B 81-COUNTY BLVD., FARMINGDALE, NY 11735

99. Full Name and Complete Mailing Address of Assistant Secretary: CONSUMER & INDUSTRIAL ELECTRONICS, INC., 588-B 81-COUNTY BLVD., FARMINGDALE, NY 11735

100. Full Name and Complete Mailing Address of Assistant Controller: CONSUMER & INDUSTRIAL ELECTRONICS, INC., 588-B 81-COUNTY BLVD., FARMINGDALE, NY 11735



CONSOLIDATED ELECTRONICS

Get two of the most valuable electronic catalogs ever! These 2 catalogs contain over 16,000 hard to find electronic parts & equipment. VOL. I - features 112 pages of high quality test equipment. VOL. II - features 144 pages of electronic parts, tools & cross references. Send \$5 check or money order, or call today & use your VISA or MasterCard.



1-800-543-3568

CONSOLIDATED ELECTRONICS, INCORPORATED 705 WATERLIET AVENUE DAYTON, OHIO 45420-2599
FAX: 1-(513)-252-4066 / TEL: 1-(513)-252-5662 / TELEX: 288-229 / COMPUERVE: 76057, 3347 / EASYLINK: 62850013

CIRCLE 70 ON FREE INFORMATION CARD

UNICORN - YOUR I.C. SOURCE!

COLLIMATOR PEN (INFRA-RED)



- Output: 2.5 mW (max.)
- Current: 90-150 mA
- Operating Voltage: 2.2-2.5V
- Wavelength: 820nm
- Collimation: .18mrad (typ.)
- Size: 11mm diameter

STOCK # PRICE
SB1052 \$39.99

LASER DIODE (INFRA-RED)

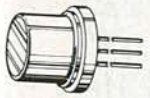

- Output: 10 mW (max.)
- Current: 90-150 mA
- Operating Voltage: 2.2-2.5V
- Wavelength: 820nm

STOCK # PRICE
SB1053 \$9.99

LASER DIODE (VISIBLE-RED)

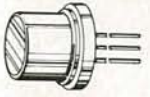

- Output: 5 mW (max.)
- Current: 65-100 mA
- Operating Voltage: 1.75-2.2V
- Wavelength: 780nm

STOCK # PRICE
LS022 \$19.99

LASER DIODE (VISIBLE-RED)



- Output: 4 mW (max.)
- Current: 20 mA
- Operating Voltage: 2.2-3.0V
- Wavelength: 665nm

STOCK # PRICE
LS3200 \$109.99

POWER SUPPLY



- Input: 115/230v
- Size 7" L x 5 1/4" W x 2 1/2" H
- Output: +5 volts @ 3.75 amps
- Output: +12 volts @ 1.5 amps
- Output: -12 volts @ .4 amps

STOCK # PRICE
PS1003 \$19.99

LASER DIODE (VISIBLE-RED)

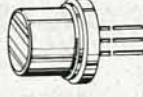

- Output: 3 mW
- Current: 85-100 mA
- Operating Voltage: 2.3-3.0V
- Wavelength: 670nm

STOCK # PRICE
LS9200 \$49.99

ANTI-STATIC SCREEN WIPES



- Individually wrapped
- Dispenser pack

STOCK # DESC. PRICE
SB1104 25 \$1.99
SB1107 100 \$4.99

DISC DRIVE & COMPUTER CLEANING KIT



- Includes: Cleaning swabs, head-cleaning fluid, anti-static cleaner, screen wipes and cleaning diskette.

STOCK # DESC. PRICE
SB1099 3 1/2" kit \$6.99
SB1100 5 1/4" kit \$6.99

EPROMS

STOCK #	1-24	25-99	100+	STOCK #	1-24	25-99	100+
1702	4.59	4.36	3.92	2764A	3.49	3.32	2.99
2708	6.49	6.17	5.55	TMS2564	5.79	5.50	4.95
2716	3.29	3.13	2.82	27C64	3.29	3.13	3.28
2716-1	3.79	3.60	3.24	27128-20	4.99	4.74	4.27
TMS2716	5.79	5.50	4.95	27128	4.79	4.55	4.09
27C16	3.99	3.79	3.41	27128A	4.79	4.55	4.09
2732	4.19	3.98	3.58	27C128	4.79	4.55	4.09
2732A-2	3.79	3.60	3.24	27256-20	5.29	5.03	4.53
2732A	3.69	3.51	3.16	27256	4.79	4.55	4.09
2732A-4	3.19	3.03	2.73	27C256	4.29	4.08	3.67
TMS2532	5.79	5.50	4.95	27512-20	6.49	6.17	5.55
TMS2532P	1.99	1.89	1.70	27512	5.99	5.69	5.12
27C32	3.79	3.60	3.24	27C512	5.99	5.69	5.12
2764-20	4.29	4.08	3.67	27C1024	12.99	12.34	11.11
2764	3.99	3.79	3.41	68764	13.99	13.24	11.96
2764A-20	3.99	3.79	3.41	68766	12.99	12.34	11.11

DYNAMIC RAMS

STOCK #	1-24	25-99	100+	STOCK #	1-24	25-99	100+
MK4027	.59	.56	.50	4464-100	2.99	2.84	2.56
4116-120	1.39	1.32	1.19	4464-120	2.79	2.65	2.39
4116-150	.99	.94	.85	4464-150	2.29	2.13	1.96
4116-200	.89	.85	.77	41256-80	2.99	2.84	2.56
4116-250	.59	.56	.50	41256-80	2.79	2.65	2.39
4164-100	1.89	1.80	1.63	41256-100	1.99	1.89	1.70
4164-120	1.69	1.61	1.55	41256-120	1.89	1.80	1.63
4164-150	1.59	1.51	1.36	41256-150	1.79	1.70	1.53
4164-200	1.39	1.32	1.19	511000-70	6.49	6.17	5.55
4416-120	1.99	1.89	1.70	511000-80	5.99	5.69	5.12
4416-150	1.79	1.70	1.53	511000-100	5.49	5.22	4.70

SAVE MONEY. DON'T RENT!

CABLE TV DESCRAMBLERS, CONVERTERS, & ACCESSORIES.

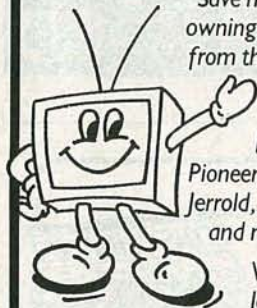

Save hundreds of dollars
owning instead of renting
from the cable company.

Easy to order
and install.

Name brands—
Pioneer, Oak, Panasonic,
Jerrold, Scientific Atlanta
and more.

We're famous for
lowest prices,
excellent service and immediate delivery.
All products fully warranted. Your
satisfaction is 100% guaranteed.

CABLE READY Company

CALL FOR FREE FULLY ILLUSTRATED
16-PAGE COLOR CATALOG.
(800) 234-1006

AMAZING SCIENTIFIC & ELECTRONIC PRODUCTS

LASERS AND SCIENTIFIC DEVICES

VRL2K	3mw Vis Red Laser Diode System Kit	\$159.50
LLIS1K	Laser Beam "Bounce" Listener Kit	\$199.50
LHC2K	Visible Simulated 3 Color Laser Kit	\$44.50
LC7	40 Watt Burning Cutting Laser Plans	\$20.00
RUB4	Hi Powered Pulsed Drilling Laser Plans	\$20.00
LGU40	1 to 2mw HeNe Vis Red Laser Gun Assembled	\$199.00
LLS1	Laser Lite Show - 3 Methods Plans	\$20.00
SD5K	See in the Dark Kit	\$299.50
EML1K	Electromagnetic Coil Gun Kit	\$69.50
MCP1	Hi Velocity Coil Gun Plans	\$15.00
LEV1	Levitating Device Plans	\$10.00
EH1	Electronic Hypnotism Techniques Plans	\$10.00

HIGH VOLTAGE AND PLASMA DISPLAY DEVICES

HVM7K	75,000 Volt DC Variable Output Lab Source Kit	\$149.50
IOG3K	Ion Ray Gun Kit, project energy without wires	\$69.50
NIG9K	12V/115 VAC Hi Out Neg Ion Generator Kit	\$34.50
EMA1K	Telekinetic Enhancer/Electric Man Assembled	\$99.50
LG5K	Lightning Display Globe Kit	\$54.50
BTC1K	Worlds Smallest Tesla Coil Kit	\$49.50
BTC3K	250KV Table Top Tesla Coil Kit	\$249.50
BTC5	1.5 Million Volts Tesla Coil Plans	\$20.00
JL3	Jacobs Ladder - 3 Models Plans	\$15.00
GRA1	Anti Gravity Generator Plans	\$10.00
PFS20	Plasma Fire Saber Assembled	\$69.50
DPL20	Dancing Plasma to Music and Sounds Assembled	\$79.50

SECURITY AND PROTECTION DEVICES

ITM10	100,000 Volt Intimidator up to 20' Assembled	\$129.50
IPG70	Invisible Pain Field Blast Wave Gen Assembled	\$74.50
PSP4K	Phasor Sonic Blast Wave Pistol Kit	\$59.50
LIST10	Infinity Xmtr, Listen in Via Phone Assembled	\$199.50
TAT30	Automatic Tel Recording Device Assembled	\$24.50
VWPM7K	3 Mi. FM Auto Tel Transmitter Kit	\$49.50
FMV1K	3 Mi. FM Voice Transmitter Kit	\$39.50
HOD1K	Homing/Tracking Beeper Transmitter Kit	\$49.50

EASY ORDERING PROCEDURE TOLL FREE 1-800-221-1705
or 24 HRS ON 1-603-673-4730 or FAX IT TO 1-603-672-5405

VISA, MC, CHECK, MO IN US FUNDS. INCLUDE 10% SHIPPING. ORDERS
\$100.00 & UP ONLY ADD \$10.00. CATALOG \$1.00 OR FREE WITH ORDER.

INFORMATION UNLIMITED
P.O. BOX 716, DEPT. R3, AMHERST, NH 03031

NEXT MONTH IN Popular Electronics

Exciting Features, Projects, Reports, & Columns

- **BUILD AN ULTRASONIC PEST REPELLER**
Our pocket-sized circuit makes outdoor fun bug free
- **MAKE YOUR OWN CUSTOM CASES**
It's easy to add eye-appeal to your next project
- **BUILD A REGENERATIVE RADIO**
An entertaining project that's based on an age-old design
- **AN "ELECTRONIC" FISHING LURE**
A fun project for the adventurous angler

Popular Electronics

APRIL 1991



ON SALE FEB. 19, 1991

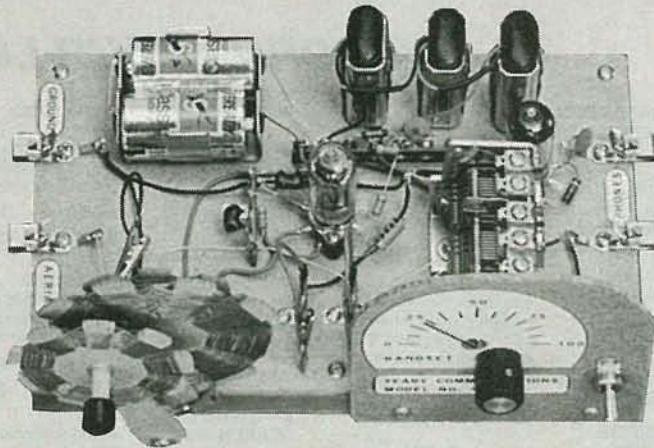

And there is more!

PRODUCT REVIEWS—JVC DAT Player, Go Video Dual-Deck VCR, Radio Shack Combination Laser Video Disc/CD Player, and much more.

DX LISTENING—Radio fare from "Down Under."

COMPUTER BITS—The "Swiss Army Knife" of utility programs.

THINK TANK—Teaching your old TTL logic gates some new tricks, a phone-line tester, an intrusion alarm, and more.

HAM RADIO—Collecting antique ham gear.

ANTIQUÉ RADIO—A theremin "bibliography."

PICK UP Popular Electronics AT YOUR FAVORITE
NEWSSTAND, CONVENIENCE STORE, OR SUPERMARKET.

QUALITY PARTS • DISCOUNT PRICES • FAST SHIPPING

ALL ELECTRONICS CORP.

12 Vdc STARTER SOLENOID

Brand NEW automotive-type solenoid (relay). 12Vdc, 4 ohm coil. SPST normally open. Negative chassis ground.



Designed for switching very heavy loads. 5/16" copper screws on switch terminals.
CAT# SOL-32 \$4.50 each

Experimenter's Delight CORDLESS TELEPHONE/TRANSCIVER

Phonemate# IQ 4210

Base station for a cordless telephone, this transceiver contains hundreds of useful parts. Includes power transformer, 600 ohm phone coupling transformer, crystals, heat sinks, voltage regulator, power cord, phone cord and jack, relay and 30" telescoping antenna. The beige chassis box has only a few holes in the back panel and would be an excellent housing for other projects. 7.25" X 5.87" X 2.15".
CAT# PMB-1 \$3.75 each **SOLD AS-IS For Parts Only. No returns accepted.**

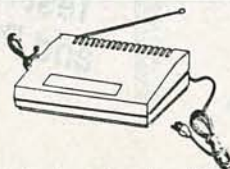

New Reduced Price PHOTOFLASH CAP.

Rubicon CE

210 Mfd 330 Volt photoflash capacitor. 0.79" dia. X 1.1" high. These are new capacitors that have been prepped with 1.4" black and red wire leads soldered to the terminals. CAT# PPC-210 \$1.25 each 10 for \$11.00 • 100 for \$100.00 Large quantities available. Call for pricing.



SWITCHES

THUMBWHEEL SWITCH

1 pole 10 position decimal encoded switches which interlock to make up desired number or digits. Terminates to 11 pc pins (1 common and 10 poles). Each section measures .31" wide X .20" high X .78" deep. End plates can be added to form a .94" high bezel.



CAT# SWTH-9 \$1.25 each 10 for \$10.00

2 END PLATES

CAT# SW-9EC \$1.00/Set

MINIATURE TOGGLE

Rated: 3 amps @ 120 Vac

S.P.D.T. (ON-ON) P.C. mount
CAT# MTS-4PC \$1.00 each 10 for \$9.00 - 100 for \$80.00

S.P.D.T. (ON-ON) solder lugs
CAT# MTS-4 \$1.35 each 10 for \$12.50 - 100 for \$110.00

D.P.D.T. (ON-ON) solder lugs
CAT# MTS-8 \$1.75 each 10 for \$15.00

D.P.D.T. (ON-ON) P.C. mount
CAT# MTS-8PC \$2.00 each 10 for \$17.50



POWER SUPPLIES

5Vdc 3 AMP

ACDC Electronics #5N3-1 New, prepped power supply with wires and connectors soldered to the inputs and outputs. Open frame style. Regulated. 4.94" X 4.03" X 2". UL and CSA listed. CAT# PS-53 \$10.00 each



12 Vdc 5 AMP

ACDC Electronics #12N5 or equiv. Input: 100-240 Vac (wired for 115 Vac) Output: 12 Vdc @ 5 amps. Open frame style. 7" X 4 3/4" X 3" high. Regulated. CAT# PS-125 \$37.50 each

24 Vdc 2.4 AMP

Power-One Inc. #HC-24-2.4 Input: 115/230 Vac (wired for 115 Vac) Output: 24 Vdc @ 2.4 amps. Open frame style. 5.62" X 4.87" X 2.50" CSA listed. CAT# PS-2424 \$30.00 each

RECHARGEABLE BATTERIES

6 Volt 1 Amp/Hour

Japan Storage Battery Co. Portalac# PEGV1 6 Volt 1 Ah rechargeable sealed lead-acid (gell cell). 2" X 1.635" X 2" high. Batteries are prepped with 5" black and red leads terminated with 2 pin connector.
CAT# GC-61 \$4.75 each 10 for \$42.50



Nickel-Cad

AAA SIZE \$1.50 each 1.2 volts 180 mAh
CAT# NCB-AAA

AA SIZE \$2.00 each 1.25 volts 500 mAh
CAT# NCB-AA

AA SIZE \$2.20 each WITH SOLDER TABS
CAT# NCB-SAA

C SIZE \$4.25 each 1.25 volts 1200 mAh
CAT# NCB-C

D SIZE \$4.50 each 1.2 volts 1200 mAh
CAT# NCB-D

HEAVY DUTY "C"

YUASA 1800C Nickel-cad heavy duty "C" cell 1.2 volt, 1800 mah Price reduced on 10 or more.
CAT# HDNCB-C 10 for \$42.50/100 for \$375.00



INSTRUMENT ENCLOSURES

High quality molded ABS instrument enclosures. Integrated PC board standoffs and two sets of vertical mounting slots for front and rear sub panels. All enclosures are 6" wide X 6 1/4" deep. Choice of three hits. Includes non-skid rubber feet and hardware. Available in beige, ivory, black, and blue.
Panel ht. CAT# 2 1/4" CAT# MB-A \$7.50 each 10 for \$65.00 2 5/8" CAT# MB-B \$7.75 each 10 for \$67.50 3" CAT# MB-C \$8.00 each 10 for \$70.00 Please specify color.



RG-11/U VIDEO CABLE

100 ft. or 200 ft. rolls of RG 11/U 75 ohm cable terminated to heavy duty F connectors. Includes 75 ohm terminator and F-61 splicer on one end. New cables manufactured for IBM PC networks. IBM P/N 1501908 COM/SCOPE.
CAT# RG-11-1 100 ft. roll \$15.00
CAT# RG-11-2 200 ft. roll \$27.50



ONE MINUTE TIMER

This white box with a blue button will drive you crazy. Box measures 3 1/4" square X 2" high. When the button is pressed 4 LEDs light and a beeper pulses. Every 15 seconds one led goes out and the speed of the beeping increases. At the end of 60 seconds the unit gives off a long beep followed by a low squeal, all LEDs shut off and the unit stops. Unit requires a 9 volt transistor battery (not included) to operate.
CAT# TMR-1 \$2.25 each • 10 for \$20.00

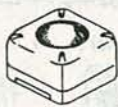

Experimentors Delight ATARI 5200 Vidio Game

Atari video game controllers returned to the dealer because of various defects. None of them work properly, but they have lots of great parts. A RF video modulator, eight 16K dynamic RAMs in sockets, microprocessors and D-A converters in sockets, two voltage regulators on a heavy-duty heatsink and lots of other ICs, capacitors, resistors, connectors and other component. Does not include the power transformer or controls (joysticks).
CAT# A-5200 \$7.50 each • 2 for \$13.50 **SOLD AS-IS For Parts Only.**



L.E.D.'s

Standard JUMBO

Diffused T 1-3/4 size (5 mm)

RED CAT# LED-1 10 for \$1.50 • 100 for \$13.00

GREEN CAT# LED-2 10 for \$2.00 • 100 for \$17.00

YELLOW CAT# LED-3 10 for \$2.00 • 100 for \$17.00

FLASHING LED W/ built in flashing circuit 5 volt operation. T 1-3/4 (5mm)

RED \$1.00 each

CAT# LED-4 10 for \$9.50

GREEN \$1.00 each

CAT# LED-4G 10 for \$9.50

YELLOW \$1.00 each

CAT# LED-4Y 10 for \$9.50

LED HOLDER Two piece holder. CAT# HLED 10 for 65¢

RED \$1.00 each

CAT# LED-4G 10 for \$9.50

YELLOW \$1.00 each

CAT# LED-4Y 10 for \$9.50

LED HOLDER Two piece holder. CAT# HLED 10 for 65¢

RED \$1.00 each

CAT# LED-4G 10 for \$9.50

YELLOW \$1.00 each

CAT# LED-4Y 10 for \$9.50

LED HOLDER Two piece holder. CAT# HLED 10 for 65¢

RED \$1.00 each

CAT# LED-4G 10 for \$9.50

YELLOW \$1.00 each

CAT# LED-4Y 10 for \$9.50

LED HOLDER Two piece holder. CAT# HLED 10 for 65¢

RED \$1.00 each

CAT# LED-4G 10 for \$9.50

YELLOW \$1.00 each

CAT# LED-4Y 10 for \$9.50

LED HOLDER Two piece holder. CAT# HLED 10 for 65¢

RED \$1.00 each

CAT# LED-4G 10 for \$9.50

YELLOW \$1.00 each

CAT# LED-4Y 10 for \$9.50

KITS

L.E.D. FLASHER KIT

Two L.E.D.'s flash in unison when a 9 volt battery is attached. This kit includes a p.c. board, all the parts and instructions to make a simple flasher circuit. A quick and easy project for anyone with basic soldering skills.
CAT# LEDKIT \$1.75 per kit



L.E.D. CHASER KIT

Build this variable speed led chaser. 10 leds flash sequentially at whatever speed you set them for. Easy to build kit includes pc board, parts and instructions. Ideal for special lighting effects, costumes, etc. Operates on 3 to 9 volts. PC board is 5" X 2.25". A great one hour project.
CAT# AEC \$6.50 each



STEPPING MOTOR CONTROLLER KIT

Learn about stepping motors while building this simple circuit. Includes circuit board, stepping motor and all parts except 12 Vdc power supply. CAT# SMKIT \$18.00 each



METRONOME KIT

This simple device can be set to click from 20 to 1,000 beats per minute. Easy to build, includes circuit board, all components and instructions. Operates on a 9 volt battery (not included).
CAT# METRO \$3.75 each



PHOTO RESISTOR

1,000 ohms bright light. 16K ohms dark. 0.182" dia. X .08" high. 0.18" long leads.
CAT# PRE-7 2 for \$1.00 100 for \$45.00 • 1000 for \$400.00



ORDER TOLL FREE 1-800-826-5432

FAX (818) 781-2653 • INFORMATION (818) 904-0524

Call Or Write For Our Free 60 Page Catalog

Outside the U.S.A. send \$2.00 postage for a catalog.

Minimum Order \$10.00 • All Orders Can Be Charged To Visa, Mastercard Or Discovercard • California, Add Sales Tax • Shipping And Handling \$3.50 For the 48 Continental United States - All Others Including Alaska, Hawaii, P.R. And Canada Must Pay Full Shipping • Quantities Limited • No C.O.D. • Prices Subject to change without notice.

DISCOVER

VISA

MasterCard

MAIL ORDERS TO: ALL ELECTRONICS CORP • P.O. BOX 567 • VAN NUYS, CA 91408

CIRCLE 107 ON FREE INFORMATION CARD

Freedom of Choice.

Test / Measurement
and Prototype Equipment

GoldStar 20MHz Oscilloscope



24 Hour
Order Hotline
(415) 592-8097

Features:

- 6" rectangular CRT display, internal graticule & scale
- Phase difference measurements between two forms under two methods x-y scope and Dual Trace
- Two different scale probes: x1 and x10
- Bandwidth from DC to 20MHz
- Includes: Two 40MHz probes, two fuses, power cord, operation manual, schematics and block and wiring diagram
- High sensitivity: 1mV/div
- Two-year manufacturer's warranty

GS7020.....\$499.95

Global Specialties Protoboard® Design Station

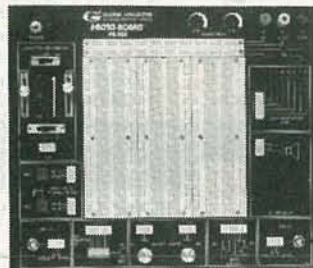

Features:

- Ideal for analog, digital and microprocessor circuits
- Triple DC regulated power supplies, +5V, +15V, -15V
- 8 logic probe circuits
- Digital pulser
- Function generator with sine, square, and triangle waveforms
- Includes power supply, instrumentation and breadboarding

PB503.....\$299.95

Jameco Logic Pulser



- Compatible with TTL, DTL, RTL, HTL, HNIL, MOS and CMOS ICs. • 1MΩ Sync input impedance • Pulser mode output current: 10mA • Square wave current output: 5mA • Audible tone

LP540.....\$16.95

Jameco Logic Probe



- Max Frequency 80MHz • Minimum detectable pulse: 10ns • 120KΩ input impedance • Max. supply voltage: ±25V • TTL threshold: (Lo)±0.8V ±0.1V (Hi) ±2.3v ±0.2V • CMOS threshold: (Lo) 30% VCC ±10% (Hi) 70%VCC ±10%

MS104.....\$24.95

A.R.T. EPROM Programmer



- Programs all current EPROMs in the 2716 to 27512 range plus the X2864 EEPROM
- RS232 port • Software included

EPP.....\$199.95

UVP EPROM Eraser



- Erases all EPROM's • Erases 1 chip in 15 minutes and 8 chips in 21 min
- UV intensity: 6800 UW/CM²

DE4.....\$79.95

PROTOTYPING PRODUCTS Jameco Solderless Breadboards

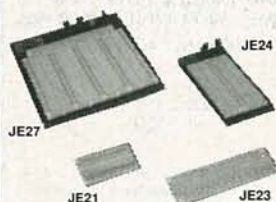

Part No.	Dim. L" x W"	Contact Points	Binding Posts	Price
JE21	3.25 x 2.125	400	0	\$4.95
JE23	6.5 x 2.125	830	0	\$6.95
JE24	6.5 x 3.125	1,360	2	\$12.95
JE25	6.5 x 4.25	1,660	3	\$17.95
JE26	6.875 x 5.75	2,390	4	\$22.95
JE27	7.25 x 7.5	3,220	4	\$32.95

Metex Digital Multimeters

General Specs:

- Handheld, high accuracy • AC/DC voltage, AC/DC current, resistance, diodes, continuity, transistor hFE
- Manual ranging w/ overload protection



M3650 & M4650 only:

- Also measure frequency and capacitance

M4650 only:

- Data hold switch • 4.5 digit

M3610	3.5 Digit Multimeter	\$59.95
M3650	3.5 Digit Multimeter w/Frequency & Capacitance	\$74.95
M4650	4.5 Digit w/Frequency, Capacitance and Data Hold Switch	\$99.95

Handheld Multimeter



- 3.5 digit LCD with automatic polarity indication
- AC/DC voltage measurement up to 500 volts
- AC/DC current measurement up to 200mA
- Resistance measurement up to 20MΩ • Continuity checker with audible tone • Diode and logic tester • Auto/manual range and data hold functions • All range protection and function indications

DMM905.....\$49.95

EPROMs - for your programming needs

Part No.	Price	Part No.	Price	Part No.	Price
TMS2516	\$4.95	2764-20	\$4.95	27256-15	\$5.95
TMS2532	6.95	2764-25	4.75	27256-20	5.75
TMS2532-35	7.49	2764-45	4.49	27256-25	5.25
TMS2532A	7.95	2764A-20	4.25	27C256-15	6.95
TMS2564	5.95	2764A-25	3.95	27C256-20	4.95
TMS2716	5.95	27C64-15	4.49	27C256-25	4.49
1702A	4.89	27C64-25	3.49	27512OTP	5.95
2708	6.95	27128OTP	4.95	27512-20	7.95
2716	3.49	27128-20	6.95	27512-25	6.95
2716-1	3.95	27128-25	6.25	27C512-15	8.95
27C16	4.25	27128A-15	6.95	27C512-20	6.95
2732	4.95	27128A-20	5.95	27C512-25	6.49
2732A-20	3.95	27128A-25	4.95	27C010-15	14.95
2732A-25	3.75	27C128-15	5.95	27C010-20	13.95
2732A-45	3.49	27C128-25	5.75	68764	14.95
27C32	3.95	27256OTP	4.95	68766-35	12.95

Soldering and Desoldering Stations

60 Watt Analog Display Soldering Station • Electronic temperature control from 200° to 878°F • Cartridge heating element for a longer life of the soldering tip

XY1683.....\$69.95

30 Watt Electronic Temperature Controlled Desoldering Station • Electronic temperature control from 212° to 842°F • Self contained high rotary vacuum pump

XY999.....\$299.95



JAMECO

24 Hour Order Hotline
(415) 592-8097

FAX: (415) 592-2503
(415) 595-2664

• Partial Listing • Over 4000 Electronic and Computer Components in Stock!

CIRCLE 114 ON FREE INFORMATION CARD

24 Hours a Day.

Computer Products and Electronic Components

Assemble Your own Computer Kit!

Jameco 16MHz 80386SX Desktop Computer Kit

- Building your own computer provides you with a better understanding of components and their functions
- In-depth assembly instructions included
- Have your new computer assembled and running in an evening, using common tools
- Software included
- Purchase computer kits configured by Jameco or design your own

Jameco 16MHz 80386SX Desktop Computer Kit

- Includes:
- 80386SX Motherboard with 2MB RAM (expandable to 8MB)
 - 101-key enhanced keyboard
 - Multi I/O Card
 - Toshiba 1.44MB, 3.5" DSHD floppy disk drive
 - Baby sized desktop case
 - 200 Watt power supply
 - DR DOS 5.0 by Digital Research and Diagsoft's QAPLUS diagnostic software



\$1199.95
JE3816 monitor extra

Hard Drives



Conner (16-bit IDE)

CP3044	40MB 3.5" Low Profile.....	\$469.95
CP3184	80MB 3.5"HH.....	\$699.95
CP3104	100MB 3.5"HH.....	\$799.95
ADP20	Host Adapter.....	\$29.95

Relisys 14" VGA Color Monitor



- Max resolution: 720 x 480
- Bandwidth: 30MHz
- Input: DB15-pin (analog)

RE9513.....\$449.95

Jameco 16-bit VGA Card



- Supports VGA, EGA, CGA, MDA and Hercules modes
- Comes with 256KB video RAM upgradable to 512KB (eight 41464-80)
- Capable of 640 x 480 with 256 colors, 800 x 600 with 16 colors

VG2000.....\$149.95

JAMECO

24 Hour Order Hotline
(415) 592-8097

FAX: (415) 592-2503
(415) 595-2664

1355 Shoreway Road
Belmont, CA 94002

Look to Jameco.....

- Wide selection of integrated circuits and components
- Quality prototype and test equipment
- Computer kits and accessories

Additional items that Jameco offers:

- Tools
- Cables
- Connectors
- Data Books
- Motherboards
- Memory
- Math Coprocessors
- Computer Accessories
- Power Protection Equipment
- Much, much more!

Let us show you what we have to offer; call or write for the latest Jameco catalog!

\$50.00 Minimum Order

Data Sheets - 50c each

For a FREE 90-Page catalog send \$2.00 to cover first class Postage and Handling
© 1991 Jameco Electronics 3/91

CA Residents Add

6.25%, 6.75% or 7.25% Sales Tax
Shipping - Add 5% plus \$1.50 Insurance
(May vary according to weight and shipping method)
Terms: Prices subject to change without notice.
Items subject to availability and prior sale.

Complete list of terms/warranties is available upon request.
IBM is a registered trademark of International Business Machines



Please refer to Mail Key 2 when ordering

Integrated Circuits

Part No.	1-9	10+	Part No.	1-9	10+
74LS00	\$.25	\$.15	74LS154	\$1.29	\$1.19
74LS02	.25	.15	74LS155	.49	.39
74LS03	.25	.15	74LS156	.49	.39
74LS04	.25	.15	74LS157	.45	.35
74LS05	.28	.18	74LS158	.39	.29
74LS06	.59	.49	74LS166	.79	.69
74LS07	.59	.49	74LS169	.99	.89
74LS08	.28	.18	74LS173	.49	.39
74LS10	.25	.15	74LS175	.39	.29
74LS11	.29	.19	74LS181	1.39	1.29
74LS13	.35	.25	74LS189	3.95	3.85
74LS14	.49	.39	74LS190	.59	.49
74LS20	.28	.18	74LS191	.59	.49
74LS21	.29	.19	74LS193	.69	.59
74LS27	.35	.25	74LS194	.69	.59
74LS30	.28	.18	74LS221	.69	.59
74LS32	.28	.18	74LS240	.59	.49
74LS38	.35	.25	74LS241	.59	.49
74LS42	.49	.39	74LS323	2.49	2.25
74LS47	.85	.75	74LS541	1.09	.99
74LS48	.85	.75	74LS590	5.95	5.75
74LS112	.39	.29	74LS670	.89	.79
74LS122	.55	.45	74LS688	2.19	1.95
74LS123	.49	.39	81LS95	.99	.89
74LS125	.49	.39	81LS97	.99	.89

Miscellaneous Components

Potentiometers

Values available (insert ohms into space marked "XX"):
500Ω, 1K, 5K, 10K, 20K, 50K, 100K, 1MEG

43PXX	3/4 Watt, 15 Turn	\$.99
63PXX	1/2 Watt, 1 Turn	\$.89

Transistors And Diodes

PN2222	\$.12	1N4735	\$.25	2N4401	\$.15
PN290712	2N390412	1N414807
1N400410	1N75115	2N305569
2N2222A25	C106B149	1N27025

Switches

JMT123	SPDT, On-On (Toggle)	\$1.25
206-8	SPST, 16-pin (DIP)	\$1.09
MPC121	SPDT, On-Off-On (Toggle)	\$1.19
MS102	SPST, Momentary (Push-Button)	\$.39

D-Sub Connectors and Hoods

DB25P	Male, 25-pin	\$.65	DB25H	Hood	\$.39
DB25S	Female, 25-pin	\$.75			

LEDs

XC209R	T1, (Red)	\$.14	XC556R	T1 ³ / ₄ , (Red) ...	\$.12
XC556G	T1 ³ / ₄ , (Green)16	XC556Y	T1 ³ / ₄ , (Yellow)16

IC Sockets

Low Profile		Wire Wrap (Gold) Level #2	
8LP	\$.11	8WW	\$.49
14LP12	14WW65
16LP13	16WW69
24LP19	24WW	1.05
28LP22	28WW	1.29
40LP28	40WW	1.79

Soldertail Standard & Header Plug Sockets Also Available

• Customer Service • Technical Assistance • Credit Department • All Other Inquiries • (415) 592-8097 • 7AM - 4PM P.S.T.

CIRCLE 114 ON FREE INFORMATION CARD

MARCH 1991

97

3 FOR 1 SPECIAL

ON SUB-MINIATURE VOICE FM TRANSMITTERS.

KITS CONTAIN PC BOARDS



***FMX-1 LONG RANGE (3 MI) ULTRA SENSITIVE FM VOICE XMTR** with fine tune, range control plus.....\$34.50



***TELX-1 TELEPHONE FM XMTR (3 MI)** automatically operates when phone is used. Crystal clear clarity with fine tune and range control. Non detectable.....\$34.50



***ATR-1 AUTOMATIC TELEPHONE RECORDING DEVICE** tapes telephone conversation all automatically.....\$19.50

ALL THREE OF ABOVE FOR.....\$69.50

CALL OR SEND VISA, MASTER CHARGE, MONEY ORDER, ETC. TO **AMAZING CONCEPTS**, BOX 716, AMHERST, NH 03031. (603) 673-4730.

THE ELECTRONIC GOLDMINE

The Electronic Goldmine has one of the greatest selections of unique electronic kits available in the world! We have over 130 kits and over 1,400 unique, bargain priced, components in our catalog!

FREE CATALOG with OVER 1400 DIFFERENT ITEMS INCLUDING 135 KITS! REQUEST YOUR COPY TODAY!

AMAZING VALUE

INEXPENSIVE GEIGER COUNTER KIT

Probably the lowest priced Geiger counter kit available in the world today! Features sensitive thin walled Geiger Mueller tube and piezoelectric speaker that emits clicks in proportion to the radiation level. Detects Beta and Gamma rays. Will detect radium dials on old watches, clocks, background radiation, nuclear fallout, etc. Only 3" x 1.88". Operates from one 9V battery (not included). Complete with all parts, PC board and instructions.

C6447 \$39.95

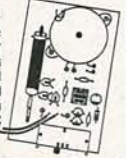

4KV TRIGGER COIL
Use with any strobe tube that needs a 3 lead 4KV trigger.
N1700 \$1.25 EA. 100 for \$80.00

PLASTIC ZIPPER CLOSE BAGS
We now offer high quality 2Mil thick zipper close bags with white block to write on. These re-closable bags feature a zipper locking top for convenient storage of small electronic parts, hardware, etc. We have the following sizes. Sold in multiples of 100 only.

2" X 3"	G663	100/\$3.30
3" X 4"	G664	100/\$3.75
3" X 5"	G665	100/\$4.00
4" X 6"	G666	100/\$5.50

INVERTER TRANSFORMER
Small 4 lead transformer for use with 555 IC to convert 12VDC to 250V for strobe/fluorescent tubes with schematic.
N1703 \$2.00 EA. 1,000 for \$1,500

RARE EARTH SUPER MAGNET 2
Many times stronger than other magnets, these are the world's strongest commercially available magnets for this size. Small size only about 1" x 5/8" x 1/2" yet can lift 12 to 15 lbs. Try to remove this magnet from a steel plate and you'll find that unless you slide it, you can't get it off. Great for thousands of experiments and applications. Normally these sell for \$60 each, but these are surplus and have a few scratches (does not effect performance).
G860 \$11.00

MINERALIGHT BLACKLIGHT LAMP
Portable short wave mineral light made by UVP. Model UVG-4 features fully portable operation from four AA batteries (not included). This light is rugged and has the famous 5000 hour SW filter to cause fluorescent minerals to glow brightly.
G812 \$29.95

MINIMUM ORDER: \$10.00 plus \$3.00 shipping and handling.
We accept MC, Visa and Money Orders.
SEND ORDERS TO: The Electronic Goldmine
P.O. Box 5408 Scottsdale, AZ 85261
PHONE ORDERS (602) 451-7454 FAX ORDERS (602) 451-9495

ADVERTISING INDEX

RADIO-ELECTRONICS does not assume any responsibility for errors that may appear in the index below.

Free Information Number	Page	—	Perfect Cable 25	
108	AMC Sales 76	101	Pomona Electronics 79
180	Ace Communications 14	184	Print Products International 26
75	Ace Products 23	78	Radio Shack 3
107	All Electronics 95	181,192	SCO Electronics 76,86
—	Amazing Concepts 94,98	—	Star Circuits 26
84	Appliance Service 23	—	Tab Books 5
67	Banner Technical Books 16	92	Tektronix 8
98	Beckman 75	123	Test Probes 17
109	C&S Sales 13	187	Unicorn 93
70	CEI 93	182	U.S. Cable 86
—	CIE 7,31	186	Viejo Publications 75
—	Cable Ready Company 94	190	WPT Publications 78
54	Chemtronics 76	—	Wholesale Cable 26
—	Command Productions 67	188	Xandi Electronics 23
58	Cook's Institute 76			
179	D&D Electronics 28			
189	Datak Corporation 27			
127	Deco Industries 23			
185	Electronic Goldmine 98			
—	Electronics Book Club 80			
121	Fluke Manufacturing CV2			
191	General Technics 23			
178	Global Specialties 32			
—	Grantham College 28			
86	Heathkit 27			
114	Jameco 96,97			
115	Jensen Tools 23			
—	King Wholesale 88			
87	MCM Electronics 91			
53	MD Electronics 90			
93	Mark V. Electronics 89			
—	McGraw Hill Book Club 38			
61	Microprocessors Unltd. 85			
117	Mouser 16			
177	Multidyne Electronics, Inc. 23			
—	NRI Schools 18			
183	Optoelectronics CV3			
56	Parts Express 92			
176	People's College 25			

ADVERTISING SALES OFFICE

Gernsback Publications, Inc.
500-B Bi-County Blvd.
Farmingdale, NY 11735
1-(516) 293-3000
President: **Larry Steckler**
Vice President: **Cathy Steckler**

For Advertising ONLY
516-293-3000
Fax 1-516-293-3115

Larry Steckler
publisher
Arlene Fishman
advertising director
Denise Haven
advertising assistant
Christina Estrada
advertising associate
Kelly McQuade
credit manager

Subscriber Customer Service
1-800-288-0652
Order Entry for New Subscribers
1-800-999-7139
7:00 AM - 6:00 PM M-F MST

SALES OFFICES
EAST/SOUTHEAST
Stanley Levitan, Eastern Sales Manager
Radio-Electronics
259-23 57th Avenue
Little Neck, NY 11362
1-718-428-6037, 1-516-293-3000
Fax 1-718-225-8594

MIDWEST/Texas/Arkansas/Okla.
Ralph Bergen, Midwest Sales Manager
Radio-Electronics
540 Frontage Road—Suite 339
Northfield, IL 60093
1-708-446-1444
Fax 1-708-446-8451

PACIFIC COAST/Mountain States
Marvin Green, Pacific Sales Manager
Radio-Electronics
5430 Van Nuys Blvd. Suite 316
Van Nuys, CA 91401
1-818-986-2001
Fax 1-818-986-2009



3000

Top of the Line Universal
Handi-Counter™ .
\$375.

OFF THE BENCH AND RUNNING

When **OPTOELECTRONICS** took frequency counters off the bench we created a whole new dimension - Frequency Finding .



2600

Super Sensitive RF
Frequency Finder.
\$325.



2210A

Full Range
Pocket
Size LED.
\$239.

Our Handi-Counters™ make Frequency Finding a reality by allowing you to pick-up radio transmitters at the maximum possible distance.

Monitoring Enthusiast, Security Specialists, Broadcast and Design Engineers, Two Way and Amateur Radio Operators and Service Technicians have all made the move. **Shouldn't you?**



8030

Bench Portable (Fits in an attaché case) with ALL the Handi-Counter™ Features plus More. \$579.



1300H/A

Low Cost Ultra
Sensitive (HF,
UHF, VHF).
\$179.

Model	Range Low High	Display 8 Digit LED	Display 10 Digit LCD	Signal Strength Bargraph	Universal Counter	TCXO Option
8030	10Hz 2.4GHz		•	•	•	± .1ppm add \$125.
3000	10Hz 2.4GHz		•	•	•	± .2ppm add \$ 80.
2600	1MHz 2.4GHz		•	•	•	± .2ppm add \$ 80.
2210A	10Hz 2.4GHz	•				± .5ppm add \$ 75.
1300H/A	1MHz 1.3GHz	•				± .5ppm add \$ 75.

Sensitivity: <1 to <10mV typical. NiCads & AC Charger/Adapter included. Carry Case, Antennas and Probes extra. One year parts & labor warranty on all products.

OPTOELECTRONICS

Toll Free Order Line:
1-800-327-5912

In Florida call (305)771-2050
FAX (305)771-2052

5821 NE 14th Avenue • Ft. Lauderdale, FL 33334
Visa, MC, COD, Cash, M.O. accepted. Personal
Check allow 3 weeks. 5% Shipping, Handling,
(Maximum \$10) U.S. & Canada. 15% outside
continental U.S.A.

Countersurveillance

Never before has so much professional information on the art of detecting and eliminating electronic snooping devices—and how to defend against experienced information thieves—been placed in one VHS video. If you are a Fortune 500 CEO, an executive in any hi-tech industry, or a novice seeking entry into an honorable, rewarding field of work in countersurveillance, you must view this video presentation again and again.

Wake up! You may be the victim of stolen words—precious ideas that would have made you very wealthy! Yes, professionals, even rank amateurs, may be listening to your most private conversations.

Wake up! If you are not the victim, then you are surrounded by countless victims who need your help if you know how to discover telephone taps, locate bugs, or "sweep" a room clean.

There is a thriving professional service steeped in high-tech techniques that you can become a part of! But first, you must know and understand Countersurveillance Technology. Your very first insight into this highly rewarding field is made possible by a video VHS presentation that you cannot view on broadcast television, satellite, or cable. It presents an informative program prepared by professionals in the field who know their industry, its techniques, kinks and loopholes. Men who can tell you more in 45 minutes in a straightforward, exclusive talk than was ever attempted before.

Foiling Information Thieves

Discover the targets professional snoopers seek out! The prey are stock brokers, arbitrage firms, manufacturers, high-tech companies, any competitive industry, or even small businesses in the same community. The valuable information they filch may be marketing strategies, customer lists, product formulas, manufacturing techniques, even advertising plans. Information thieves eavesdrop on court decisions, bidding information, financial data. The list is unlimited in the mind of man—especially if he is a thief!

You know that the Russians secretly installed countless microphones in the concrete work of the American Embassy building in Moscow. They converted



**CALL
TOLL
FREE**

1-800-522-6260

**HAVE YOUR
VISA or MC CARD
AVAILABLE**

what was to be an embassy and private residence into the most sophisticated recording studio the world had ever known. The building had to be torn down in order to remove all the bugs.

Stolen Information

The open taps from where the information pours out may be from FAX's, computer communications, telephone calls, and everyday business meetings and lunchtime encounters. Businessmen need counselling on how to eliminate this information drain. Basic telephone use coupled with the user's understanding that someone may be listening or recording vital data and information greatly reduces the opportunity for others to purloin meaningful information.

The professional discussions seen on the TV screen in your home reveals how to detect and disable wiretaps, midget radio-frequency transmitters, and other bugs, plus when to use disinformation to confuse the unwanted listener, and the technique of voice scrambling telephone communications. In fact, do you know how to look for a bug, where to look for a bug, and what to do when you find it?

Bugs of a very small size are easy to build and they can be placed quickly in a matter of seconds, in any object or room. Today you may have used a telephone handset that was bugged. It probably contained three bugs. One was a phony bug to fool you into believing you found a bug and secured the telephone. The second bug placates the investigator when he finds the real thing! And the third bug is found only by the professional, who continued to search just in case there were more bugs.

The professional is not without his tools. Special equipment has been designed so that the professional can sweep a room so that he can detect voice-activated (VOX) and remote-activated bugs. Some of this equipment can be operated by novices, others require a trained countersurveillance professional.

The professionals viewed on your television screen reveal information on the latest technological advances like laser-beam snoopers that are installed hundreds of feet away from the room they snoop on. The professionals disclose that computers yield information too easily.

This advertisement was not written by a countersurveillance professional, but by a beginner whose only experience came from viewing the video tape in the privacy of his home. After you review the video carefully and understand its contents, you have taken the first important step in either acquiring professional help with your surveillance problems, or you may very well consider a career as a countersurveillance professional.

The Dollars You Save

To obtain the information contained in the video VHS cassette, you would attend a professional seminar costing \$350-750 and possibly pay hundreds of dollars more if you had to travel to a distant city to attend. Now, for only \$49.95 (plus \$4.00 P&H) you can view *Countersurveillance Techniques* at home and take refresher views often. To obtain your copy, complete the coupon below or call toll free.

RADIO-ELECTRONICS VIDEO OFFER		RE
500-B Bi-County Blvd. Farmingdale, NY 11735		
Please rush my copy of the Countersurveillance Techniques Video VHS Cassette for \$49.95 plus \$4.00 for postage and handling.		
No. of Cassettes ordered	_____	
Amount of payment \$	_____	
Bill my <input type="checkbox"/> VISA <input type="checkbox"/> MasterCard		
Card No.	_____	
Expire Date	____/____/____	
Signature	_____	
Name	_____	
Address	_____	
City	_____ State _____ ZIP _____	
All payments in U.S.A. funds. Canadians add \$4.00 per VHS cassette. No foreign orders. New York State residents add applicable sales tax.		